



Cardinal Health™

# Surgical Drapes and Gowns





**We've got  
you covered**  
from our door  
to your OR floor

Our comprehensive portfolio of surgical gowns helps keep clinicians protected and comfortable in the OR. Surgical drapes protect patients' delicate skin while protecting them from contamination during surgery.



# Contents

## **Surgical gowns** \_\_\_\_\_ **2-7**

AAMI level guide _____	2-3
AAMI level 3 gowns _____	4
AAMI level 4 gowns _____	5-6
Coolsource™ Cooling System _____	7

## **Surgical drapes and packs** \_\_\_\_\_ **8-90**

Ancillary _____	8-14
Ancillary patient drapes _____	9-11
Drape accessories _____	12
Equipment drapes and covers _____	13-14
Angiography _____	15-20
Cardiovascular _____	21-24
Central Line _____	25-27
Cystoscopy _____	28-29
General Surgery _____	30-37
Neurosurgery _____	38-39
Obstetrics _____	40-42
Ophthalmology and EENT _____	43-47
Orthopedics _____	48-59
Heavy-duty _____	49-50
Pacemaker _____	60-61
Pediatrics _____	62-64
Peri-GYN _____	65-69
Special procedures _____	70-72
Standard packs _____	73-90

## **Indexes** \_\_\_\_\_ **91-99**

Sterile number index _____	91-93
Nonsterile number index _____	94-96
Product index _____	97-99

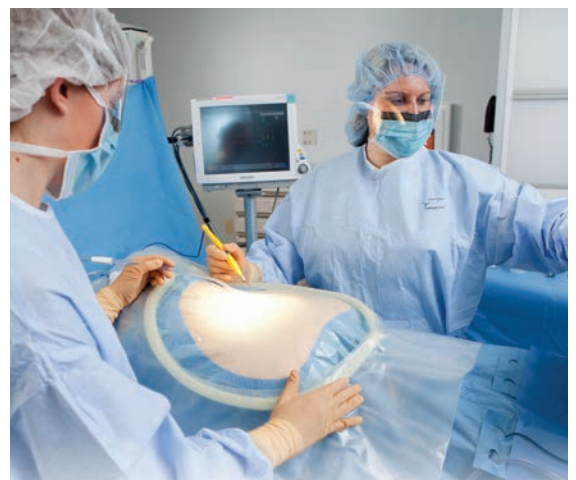



## Cardinal Health™ Surgical Gowns

# The right protection for your best care

Least protective → Most protective



Minimal



Low



Moderate



High

AAMI established standard ANSI/AAMI PB70:2022 for protective apparel, including surgical gowns, outlining the testing requirements for the four different AAMI levels. The FDA recognizes this standard for all surgical gown manufacturers.

## Dress for success

In the clinical setting, success equals safety. At their respective AAMI levels, surgical gowns protect your team from fluid exposure and blood-borne pathogens. Your safety comes first, and donning the right surgical gown at the right AAMI level is a critical first step.

### When selecting a gown, consider:

**1** How much exposure is expected?

**2** How long will the exposure last?

**3** What is my role in the procedure?

AAMI levels determined by ANSI/AAMI PB70:2022 — Suggested guidelines are not a substitute for clinician professional judgment and experience.

## AAMI Level 3

These surgical gowns have the ability to resist **moderate** fluid exposure

### Includes:

- Non-Reinforced
- Fabric Reinforced

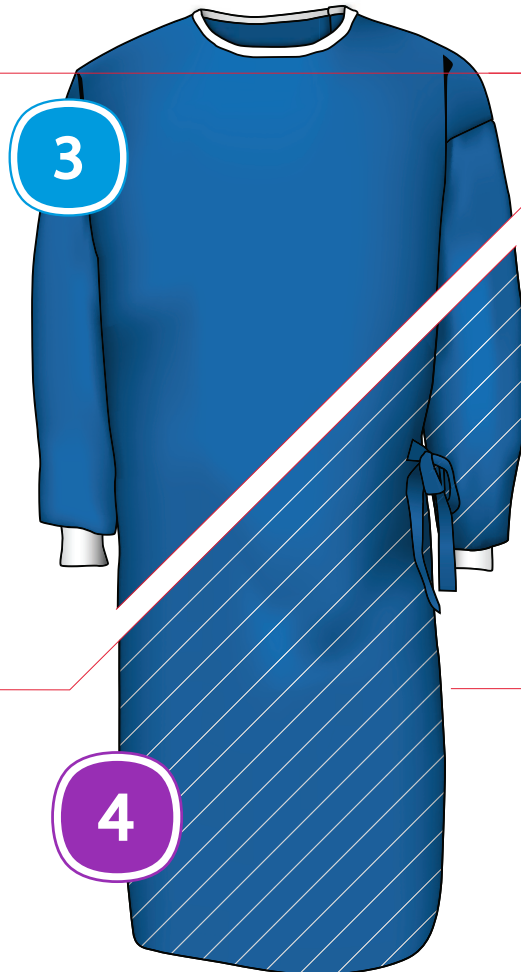

### AAMI Level 3 procedures

- Mastectomies
- Arthroscopic orthopedic procedures
- Endoscopic urological procedures such as transurethral prostate resections (TURP)

## AAMI Level 4

These surgical gowns have the ability to resist **high** fluid exposure and blood-borne pathogens

### Includes:

- Breathable film
- Poly reinforced

### AAMI Level 4 procedures

- Any procedure in which the surgeon's hands and arms are in the body cavity
- Orthopedic procedures during which tourniquets are not used
- Open cardiovascular or thoracic procedures
- Trauma procedures
- Cesarean sections

 Indicates an integrated layer of film for added protection

Procedure suggestions per AAMI TIR11:2005 AAMI levels per ANSI/AAMI PB70:2022



## AAMI Level 3 surgical gowns

### Non-reinforced surgical gowns

Sterile No.	Nonsterile No.	Description	Qty. Cs
9505	N/A	Small/medium	20
9515	9515NB	Large	20
9545	9545NC	X-Large	20
9545ELA	9545ELNA	X-Large, X-Long	20
9575	9575NB	2X-Large	18
9575EL	9575ELNA	2X-Large, X-Long	16
9585	9585N	3X-Large	18
95995	95995N	3X-Large, X-Long	20
9599	N/A	4X-Large	18
<b>Scrub nurse* gowns</b>			
N/A	90270NB	Large	N/A
N/A	90370NB	X-Large	N/A

### Fabric-reinforced surgical gowns

Sterile No.	Nonsterile No.	Description	Qty. Cs
9511	9511NB	Large	20
9541	9541NA	X-Large	18
9571	9571NA	2X-Large	18
<b>Scrub nurse* gowns</b>			
N/A	90970NA	Large	N/A
N/A	91070NB	X-Large	N/A

### RoyalSilk™ Non-Reinforced Surgical Gowns

Sterile No.	Nonsterile No.	Description	Qty. Cs
9518	9518NC	Large	20
9548	9548NC	X-Large	20
9578	9578NB	2X-Large	18
95998	95998N	3X-Large, X-Long	20
<b>Scrub nurse* gowns</b>			
N/A	90280NC	Large	N/A
N/A	90380NC	X-Large	N/A

\*Scrub nurse gowns are bulk nonsterile (BNS) gowns intended for procedure kits  
The gown and hand towel are wrapped in SMS material for placement in the kit.  
AAMI levels determined per ANSI/AAMI PB70:2022



### Did you know?

Cardinal Health has established a standard color-coding system for quick AAMI level identification on labels, transfer tabs and stickers:

**Blue** for AAMI Level 3

**Purple** for AAMI Level 4

## AAMI Level 4 surgical gowns

Cardinal Health™ SmartGown™ Surgical Gowns feature complete AAMI Level 4 protection with a unique RESPONSIVEMEMBRANE™ technology to transport moisture from the skin to the surface of the fabric to help keep clinicians cool, dry and comfortable.

### SmartGown™ Breathable Surgical Gowns

Sterile No.	Nonsterile No.	Description	Qty. Cs
89005	89005N	Small/medium	20
89015	89015NB	Large	20
89045	89045NB	X-Large	18
89075	89075NA	2X-Large	14
89085	89085N	3X-Large	12
89095	89095N	4X-Large	12

### SmartGown™ Breathable Surgical Gowns with raglan sleeves

Sterile No.	Nonsterile No.	Description	Qty. Cs
39015	39015NA	Large	20
39019	39019N	Large, X-Long	14
39045	39045NB	X-Large	18
39049	39049NA	X-Large, X-Long	14
39075	39075NB	2X-Large	14
39079	39079NB	2X-Large, X-Long	14
39099	39099NA	3X-Large, X-Long	14
32474	32474NA	X-Large, X-Long, A-Line	16

### SmartGown™ Breathable Scrub Nurse\* Gowns

Sterile No.	Nonsterile No.	Description	Qty. Cs
N/A	324740NA	X-Large, X-Long, A-Line	N/A
N/A	890015NA	Large	N/A
N/A	890045NA	X-Large	N/A

\*Scrub nurse gowns are bulk nonsterile (BNS) gowns intended for procedure kits. The gown and hand towel are wrapped in SMS material for placement in the kit. AAMI levels determined per ANSI/AAMI PB70:2022

### SmartGown™ EDGE Breathable Surgical Gown with ASSIST™ Instrument Pockets

The first surgical gown with instrument pockets, providing convenient access to frequently used surgical instruments.\*

Sterile No.	Nonsterile No.	Description	Qty. Cs
99015	99015N	Large	20
99045	99045N	X-Large	18
99075	99075N	2X-Large	14

\*Sharp, hot, heavy or long instruments should not be placed in pockets or holster.



89015



99015



## AAMI Level 4 surgical gowns

### Poly-reinforced surgical gowns

Sterile No.	Nonsterile No.	Description	Qty. Cs
9010	9010NB	Large	20
9040	9040NB	X-Large	20
9070	9070NA	2X-Large	18
<b>Scrub nurse* gowns</b>			
N/A	90680NB	Large	N/A
N/A	90780NB	X-Large	N/A

### SmartSleeve™ Poly-Reinforced Breathable Sleeve Surgical Gowns

Sterile No.	Nonsterile No.	Description	Qty. Cs
9011	9011NB	Large	20
9011EL	9011ELNB	Large, X-Long	20
9041	9041NA	X-Large	20
9041EL	9041ELNA	X-Large, X-Long	20
9071	9071NA	2X-Large	20
9071EL	9071ELNA	2X-Large, X-Long	20
9560	9560N	3X-Large, X-Long	20
<b>Scrub nurse* gowns</b>			
N/A	90020NA	Large	N/A
N/A	90030NA	X-Large	N/A

\*Scrub nurse gowns are bulk nonsterile (BNS) gowns intended for procedure kits. The gown and hand towel are wrapped in SMS material for placement in the kit. AAMI levels determined per ANSI/AAMI PB70:2022





## CoolSource™ Cooling System

# It's time to turn up staff satisfaction

With the CoolSource™ Cooling System, six cooling pack placement options targeted at heat zones lower core body temperatures and maximize cooling\* — especially during long and labor-intensive procedures. Plus, the vest is easy to put on and conforms to your body, providing a custom fit that moves comfortably with you.

### Key features:

#### CoolSource™ Cooling Vest

- Lightweight, disposable design
- Six pockets intentionally placed for cooling dispersion
- Nonsterile, worn underneath PPE
- Velcro® closures
- Belt for an adjustable fit
- Patented design

#### CoolSource™ Cooling Pack

- Lightweight, flexible design
- Six reusable cooling packs used per cooling vest
- Non-woven casing helps prevent condensation
- 2+ hour cooling duration\*

Nonsterile No.	Size	Packaging
COOLVESTM	Medium	10 ea/bg; 2 bg/cs
COOLVESTL	Large	10 ea/bg; 2 bg/cs
COOLVESTXL	X-Large	10 ea/bg; 2 bg/cs
COOLPACK	N/A	54 ea/cs

\*Cooling may vary due to environmental conditions.



CoolSource™ Cooling Vest









CoolSource™ Cooling Pack



**Surgical Drapes and Packs**

# Ancillary

 Basic drape fabric	 Reinforcements	 Side panel material
 Adhesive	 Incise	 Clear plastic panels, anesthesia screens and pouches

## Surgical Drapes and Packs

# Ancillary Patient Drapes

### Drape Towels

Sterile No.	Nonsterile No.	Description	Qty. Pkg	Qty. Cs
7550	8520N	Absorbent towel, white, 14.5 x 21 in. (37 x 53 cm)	2	120
7552	N/A	Blue drape towel, non-absorbent, sterile, 15 x 26 in. (38 x 66 cm)	2	120
D1089	D1089NS	Utility drape (2 drapes per pkg) 24 x 26 in. (61 x 66 cm)	2	20
7553	8554NA	Blue drape towel, non-absorbent with adhesive strip, sterile, 15 x 26 in. (38 x 66 cm)	2	120
7554	7554NA	Drape Towel with adhesive strip, sterile, 19 x 30 in. (48 x 76 cm)	2	60
3523	N/A	Fenestrated poly-lined towel, white absorbent, 18 x 26 in. (45 x 66 cm), 2.5 in. aperture, sterile	1	100
3520	N/A	Poly-lined towel, white, absorbent, 17 x 22 in. (43 x 56 cm)	1	100
D1000	D1000NS	Towel drape 18 x 12 in. (45 x 30 cm), adhesive 18 x 1.5 in. (45 x 3.8 cm)	1	10
D1010	D1010NS	Towel drape 18 x 24 in. (45 x 61 cm), adhesive 18 x 1.5 in. (45 x 3.8 cm)	1	10

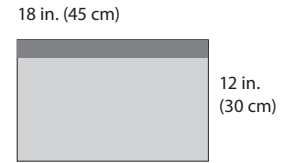

D1000

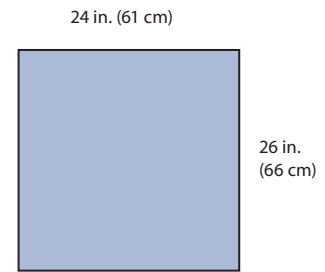

D1089

# Ancillary Patient Drapes

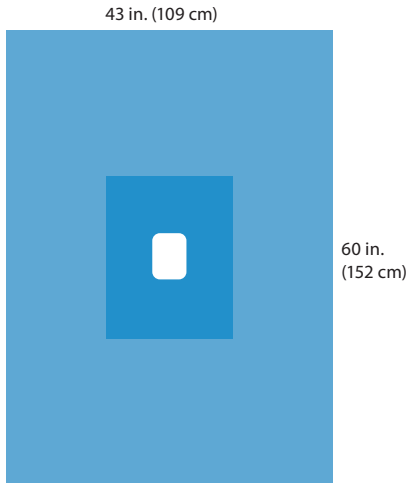
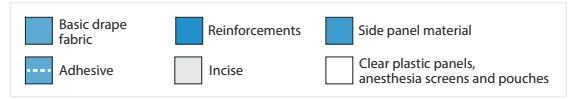

9462 Utility Drape Sheet

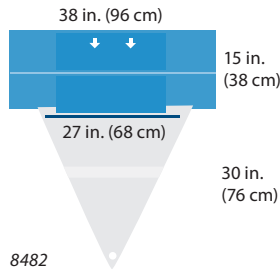

8482

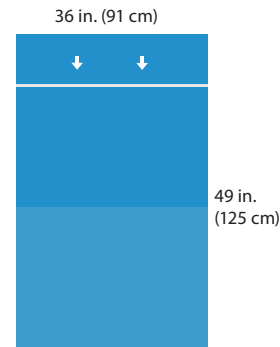

8483

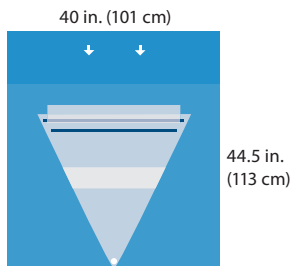

8487

## Drape Sheets

Sterile No.	Nonsterile No.	Description	Qty. Cs
9358	9358NB	Half Sheet, 40 x 57 in. (101 x 145 cm)	20
9355	9355NB	Medium Sheet, 40 x 71 in. (101 x 180 cm)	20
9349	9349NB	Three-Quarter Sheet, 52 x 76 in. (132 x 193 cm)	20
TB9349CE	TB9349NB	Three-Quarter Sheet, absorbent, 60 x 76 in. (152 x 193 cm)	20
29350	29350NC	Three-Quarter Sheet, 56 x 77 in. (142 x 195 cm), with absorbent reinforcement, 25 x 42 in. (63 x 106 cm)	20
9446	9446NA	Large Sheet, 72 x 85 in. (183 x 216 cm)	30
9444	9444NA	X-Large Sheet, 77 x 98 in. (195 x 249 cm)	12
9462	9462N	Utility Drape Sheet, 43 x 60 in. (109 x 152 cm), 4 x 6 in. (10 x 15 cm), poly-reinforced fenestration	20
N/A	8750NA	Prep pad, absorbent, 9 in. cuff, 24 x 41.5 in. (61 x 105.5 cm), nonsterile	50

## Drape Sheet, Square-Folded

Sterile No.	Nonsterile No.	Description	Qty. Cs
9461	9461N	Drape Sheet, square-folded, 38.5 x 38.5 in. (98 x 98 cm)	30

## Drape Sheets with Adhesive

Sterile No.	Nonsterile No.	Description	Qty. Cs
M9471	N/A	Drape Sheet with adhesive, 38.5 x 38.5 in. (98 x 98 cm)	30
9464	N/A	Three-Quarter Sheet with adhesive, 60 x 76 in. (152 x 193 cm)	26

## Under-Buttocks Drapes

Sterile No.	Nonsterile No.	Description	Qty. Cs
8482	8482N	Under-buttocks drape, 38 x 15 in. (96 x 38 cm), with fluid control pouch, filtering screen, closed drainage port and reinforcement, 27 x 30 in. (69 x 76 cm)	20
8483	8483N	Under-buttocks drape, reinforced poly, 9 in. cuff, 36 x 49 in. (91 x 125 cm)	40
8484	8484NA	Under-buttocks drape, 38 x 15 in. (96 x 38 cm), with fluid control pouch, reinforcement, 27 x 33 in. (69 x 84 cm)	20
8486	8486NA	Under-buttocks drape, 40 x 44 in. (101 x 112 cm), with fluid control pouch, filtering screen and closed drainage port, plastic backing, 27 x 30 in. (69 x 76 cm)	20
8487	8487NA	Under-buttocks drape with graduations, 40 x 44.5 in. (101 x 113 cm), fluid control pouch with filtering screen and closed drainage port, plastic backing, 27 x 30 in. (69 x 76 cm)	20

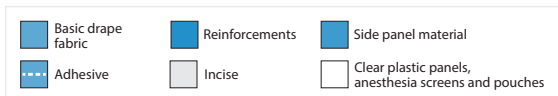

## Surgical Drapes and Packs

# Ancillary Patient Drapes

### Leggings

Sterile No.	Nonsterile No.	Description	Qty. Cs
8420	8420NB	Leggings, folded, 6 in. cuff, 28 x 43 in. (71 x 109 cm), 2/pkg.	20
8421	8421NB	Leggings, folded, 6 in. cuff, 31 x 48 in. (79 x 123 cm), 2/pkg.	20
8430	8430N	Clear leggings, folded, 6 in. cuff, 31 x 55 in. (79 x 140 cm), 2/pkg.	20
8433	8433NA	X-Large leggings, folded, 6 in. cuff, 33 x 51 in. (84 x 130 cm), 2/pkg.	20

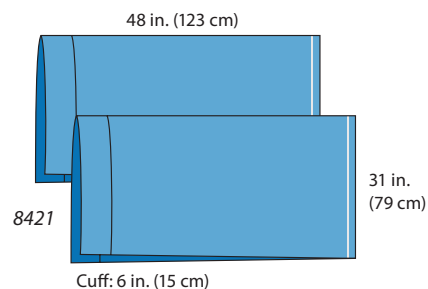

### Stockinettes

Sterile No.	Nonsterile No.	Description	Size	Qty. Cs
1584	N/A	Stockinette, small	6 x 30 in. (15 x 76 cm)	30
1585	1585N	Stockinette, medium	8 x 38 in. (20 x 96 cm)	30
1586	1586N	Stockinette, large	9 x 48 in. (23 x 122 cm)	40
1587	1582NB	Stockinette, X-Large	12 x 48 in. (31 x 122 cm)	40

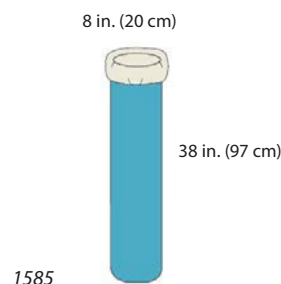

### Poly U-Drapes

Sterile No.	Nonsterile No.	Description	Size	Qty. Cs
8474	8474N	Blue poly U-drape, 6 x 21 in. split with adhesive	60 x 60 in. (152 x 152 cm)	28
8475	8475NA	Blue poly U-drape, 8 x 30 in. split with adhesive	60 x 84 in. (152 x 213 cm)	22
8476	8476NA	Blue poly U-drape, 6 x 21 in. split with adhesive	60 x 72 in. (152 x 183 cm)	24
D1015	D1015NS	Clear poly U-drape, Adhesive 9.5 x 19.5 in. (24 x 50 cm), split 6 x 19 in. (15 x 48 cm)	48 x 52 in. (121 x 132 cm)	10
D1019A	D1019NS	Clear poly U-drape, Adhesive 9.5 x 19.5 in. (24 x 50 cm), Adhesive tab 3 x 1 in. (7 x 2.5 cm), split 6 x 19 in. (15 x 48 cm)	48 x 71 in. (121 x 180 cm)	10

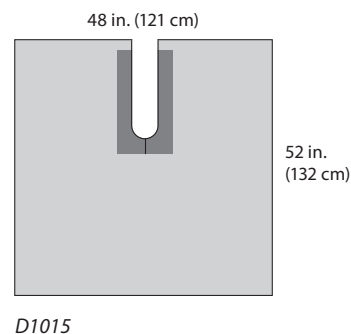





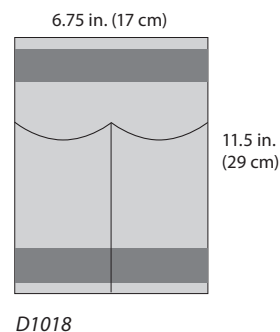

### Pouches

Sterile No.	Nonsterile No.	Description	Qty. Cs
D1018	D1018NS	Instrument pouch 6.75 x 11.5 in. (17 x 29 cm), Adhesive (2) 6.75 x 2 in. (17 x 5 cm)	10
D1018L	D1018LNS	Instrument pouch 10 x 18 in. (26 x 45 cm), Adhesive (2) 10 x 2 in. (26 x 5 cm)	10



Ancillary

# Drape Accessories

 Basic drape fabric	 Reinforcements	 Side panel material
 Adhesive	 Incise	 Clear plastic panels, anesthesia screens and pouches

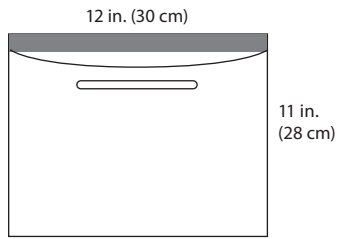

D2114

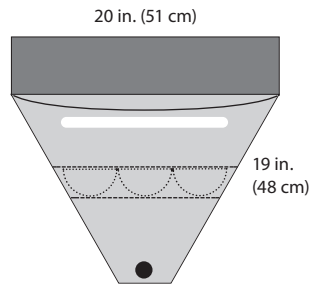

D1016

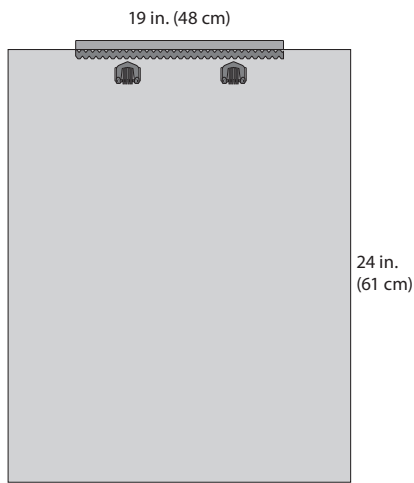

9454

## Pouches

Sterile No.	Nonsterile No.	Description	Qty. Cs
D2114	D2114NS	Irrigation pouch 12 x 11 in. (30 x 28 cm), Adhesive 12 x 1 in. (30 x 2.5 cm)	10
C2326*	C2326NS*	Irrigation pouch 30 x 11 in. (76 x 28 cm), Adhesive 30 x 1 in. (76 x 2.5 cm)	10
D1016	D1016NS	Fluid pouch 20 x 19 in. (51 x 48 cm), Adhesive 20 x 3.75 in. (50 x 9 cm)	10
D1072	D1072NS	Aperture pouch 18 x 9 in. (45 x 22 cm), Aperture 4.75 x 3.75 in. (12 x 9 cm), Adhesive 9.5 x 9 in.	10

\* Denotes a 6-8 week lead time

## Isolation Bags

Sterile No.	Nonsterile No.	Description	Qty. Cs
D5510	D5510NS	Isolation bag 18 x 18 in. (45 x 45 cm)	40

## Hair Management Drapes

Sterile No.	Nonsterile No.	Description	Qty. Cs
9454	N/A	Stray Away™ Hair Management Drape, 19 x 24 in. (48 x 61 cm)	40

## Equipment Drapes and Covers

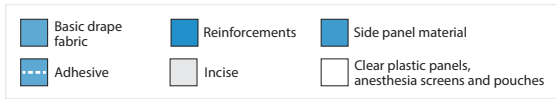



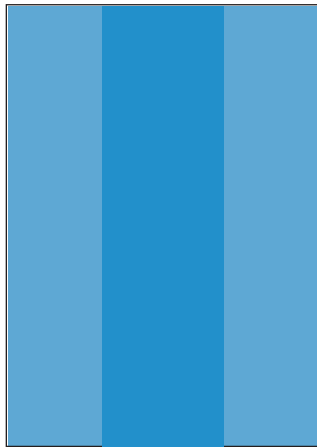



44 in. (112 cm)

90 in.  
(229 cm)

8377

## Back Table Covers

Sterile No.	Nonsterile No.	Qty. Cs	Width (in.)	Length (in.)	Reinforcement width (in.)	Unfolded	Pre-Folded	Heavy duty	Reinforcement material
-	8181NA	N/A	47	50	29		X		SMS
-	8191N	N/A	47	50	29	X			SMS
8376	-	22	44	75	23		X		SMS
-	8145N	N/A	44	75	23	X			SMS
-	8376N	N/A	44	75	23		X		SMS
-	8145NW	N/A	44	75	23	X			cellulose
-	8371NI	N/A	55	75	29		X		SMS
8377	-	22	44	90	23		X		SMS
-	8146N	N/A	44	90	23	X			SMS
-	8377N	N/A	44	90	23		X		SMS
-	8146NW	N/A	44	90	23	X			cellulose
8378	-	24	50	90	29		X		SMS
-	8184N	N/A	48	90	29	X			SMS
-	8183N	N/A	50	90	29		X		SMS
-	8184NW	N/A	50	90	29	X			cellulose
8380	-	22	80	90	39.5		X		SMS
-	8189N	N/A	80	90	39.5	X			SMS
-	8187N (Overhead)	N/A	80	90	39.5		X		SMS
9385 (Overhead)	-	12	80	90	39.5		X		SMS
-	8188NC (Overhead)	N/A	80	90	39.5		X		SMS
8186	-	24	60	90	29		X	X	SMS
-	8186NA	N/A	60	90	29	X		X	SMS
-	8196NA	N/A	60	90	29		X	X	SMS
-	8186NW	N/A	65	90	29	X		X	cellulose
8385	-	10	80	108.75	35.5		X		SMS
-	8152N	N/A	80	110	35.5	X		X	SMS

 Basic drape fabric	 Reinforcements	 Side panel material
 Adhesive	 Incise	 Clear plastic panels, anesthesia screens and pouches

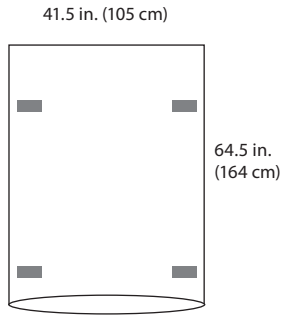

D1013

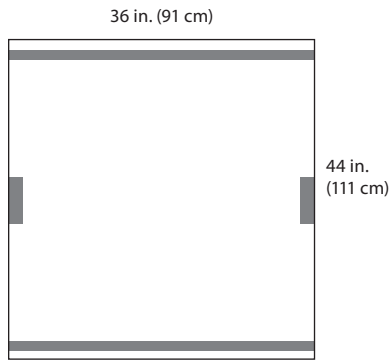

D1012

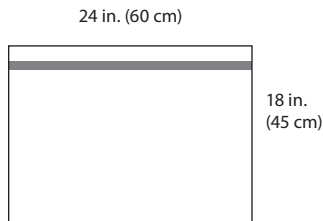

D2158

### Mayo Stand Covers

Sterile No.	Nonsterile No.	Description	Qty. Cs
8337	8337N	Mayo stand cover, reinforced poly, 22.75 x 55.5 in. (158 x 141 cm)	30
8339	8339NA	Mayo stand cover, reinforced poly, 29.5 x 55 in. (75 x 140 cm)	22

### Equipment Covers

Sterile No.	Nonsterile No.	Description	Qty. Cs
D1013	D1013NS	C-Arm Cover 41.5 x 64.5 in. (105 x 164 cm), Adhesive (4) 1 x 3 in. (2.5 x 8 cm)	10
D1012	D1012NS	Fluoroscope Cover 36 x 44 in. (91 x 111 cm), Adhesive strips 36 x 0.5 in. (91 x 1.2 cm), Adhesive tabs 2.5 x 4.25 in. (6 x 11 cm)	10
D2158	D2158NS	Instrument Cover 24 x 18 in. (60 x 45 cm), Adhesive 24 x 0.5 in. (60 x 1.2 cm)	10
D2008A	D2008NS	Clear Cover 44 x 72 in. (111 x 182 cm)	25





Angiography

Surgical Drapes and Packs

# Angiography

# Surgical Drapes and Packs

## Angiography

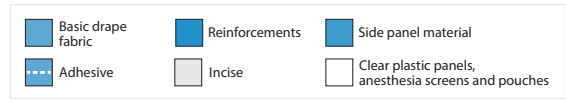

### Femoral Angiography Drape with Catheter Pouch

Sterile No.	Nonsterile No.	Qty. Cs
29459	29459NB	16

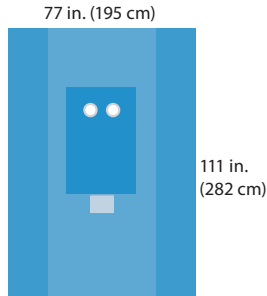

- Absorbent reinforcement, 28.75 x 44 in. (73 x 112 cm)
- Fenestration, dual circular, 6 in. (15 cm), with circular incise aperture, 3.5 in. (9 cm)
- Catheter pouch, 8.5 x 11.5 in. (21.5 x 29 cm)

### Femoral Angiography Drape

Sterile No.	Nonsterile No.	Qty. Cs
29456	29456NB	14

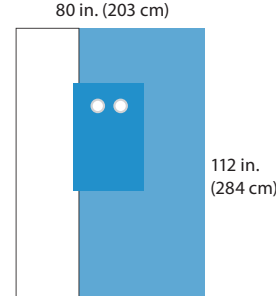

- Absorbent reinforcement, 28.75 x 44 in. (73 x 112 cm)
- Fenestration, dual circular, 6 in. (15 cm), with circular incise aperture, 3.5 in. (9 cm)
- Single clear side panel on patient's right side

### Femoral Angiography Drape

Sterile No.	Nonsterile No.	Qty. Cs
29460	29460NB	16

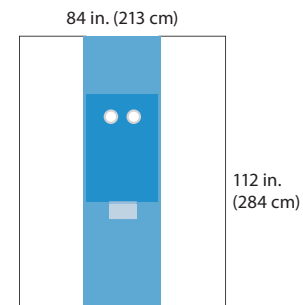

- Absorbent reinforcement, 28.75 x 44 in. (73 x 112 cm)
- Fenestration, dual circular, 6 in. (15 cm), with circular incise aperture, 3.5 in. (9 cm)
- Catheter pouch, 8.5 x 11.5 in. (21 x 29 cm)
- Clear side panels

### Femoral Angiography Drape

Sterile No.	Nonsterile No.	Qty. Cs
29520	29520NA	16

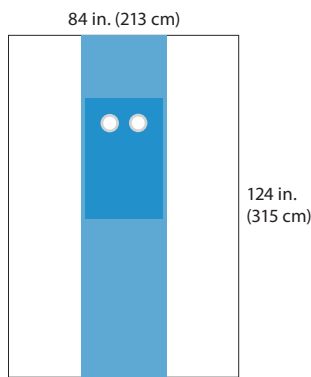

- Absorbent reinforcement, 28.75 x 44 in. (73 x 112 cm)
- Fenestration, dual circular, 6 in. (15 cm), with circular incise aperture, 3.5 in. (9 cm)
- Clear side panels

### Femoral Angiography Drape with Expanded Reinforcement

Sterile No.	Nonsterile No.	Qty. Cs
29556	29556NC	8

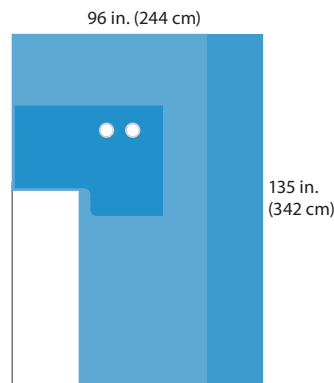

- Absorbent reinforcement, 28.75 x 44 in. (73 x 112 cm) fenestrated area, 28.75 x 32 in. (73 x 81 cm) above clear panel
- Fenestration, dual circular, 6 in. (15 cm), with circular incise aperture, 3.5 in. (9 cm)
- Single clear side panel on patient's right side

### Angiography Sheet

Sterile No.	Nonsterile No.	Qty. Cs
D2244	D2244NS	20

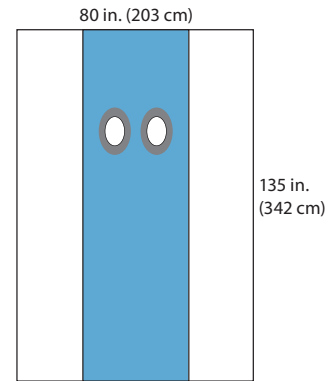

- Absorbent central panel, 29 x 135 in. (74 x 342 cm)
- Apertures, 3.5 x 4.5 in. (9 x 11 cm)
- Clear side panels
- Fenestration, dual oval, 7.25 x 6.5 in. (18.5 x 16.5 cm) with oval incise aperture 4.5 x 3.5 in. (11.5 x 9 cm)

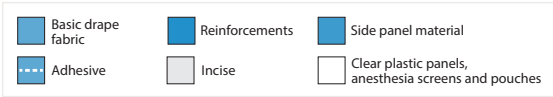

**Angiography Sheet**

Sterile No.	Nonsterile No.	Qty. Cs
D2286	D2286NS	20

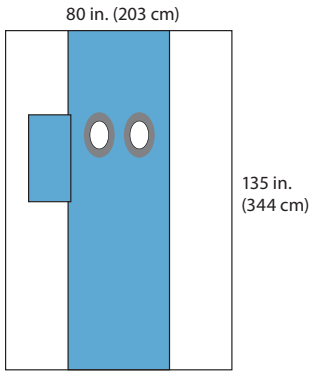

- Absorbent central panel, 29 x 135 in. (74 x 342 cm)
- Additional absorbent pad, 14.5 x 33 in. (36 x 84 cm)
- Apertures, 3.5 x 4.5 in. (9 x 11 cm)
- Clear side panels

**Femoral Angiography Drape with Trough**

Sterile No.	Nonsterile No.	Qty. Cs
29560	29560NC	8

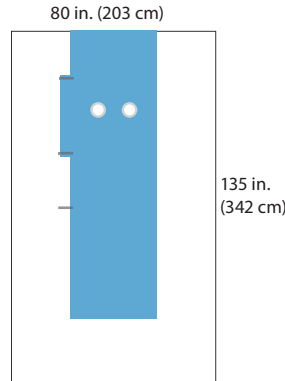

- Absorbent reinforcement, 33.5 x 111 in. (85 x 282 cm)
- Fenestration, dual circular, 6 in. (15 cm), with circular incise aperture, 3.5 in. (9 cm)
- Clear side panels
- Clear foot panel
- Malleable bars with 4 x 32 in. (108 x 81 cm) trough

**Angiography Sheet**

Sterile No.	Nonsterile No.	Qty. Cs
N/A	D2294NSC	N/A

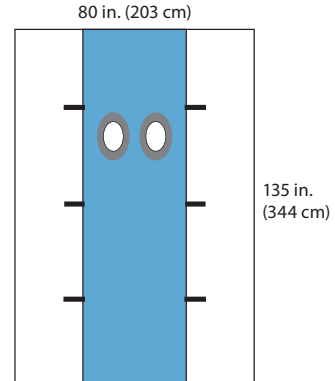

- Absorbent central panel, 29 x 135 in. (74 x 342 cm)
- Apertures, 3.5 x 4.5 in. (9 x 11 cm)
- Clear side panels
- Malleable bars on right and left panels

**Femoral Angiography Drape with Single Pouch**

Sterile No.	Nonsterile No.	Qty. Cs
29525	29525NA	10

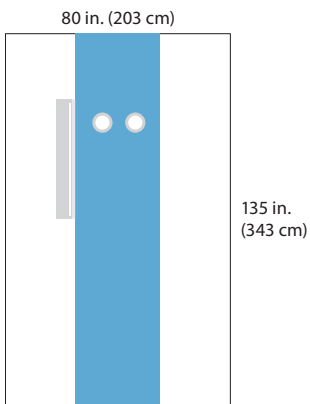

- Absorbent reinforcement, 36 x 135 in. (91 x 343 cm)
- Fenestration, dual circular, 6 in. (15 cm), with circular incise aperture, 3.5 in. (9 cm)
- Clear side panels
- Clear pouch on patient right side, 6 x 44 in. (15 x 112 cm)

**Angiography Sheet**

Sterile No.	Nonsterile No.	Qty. Cs
D2288C	D2288NSC	20

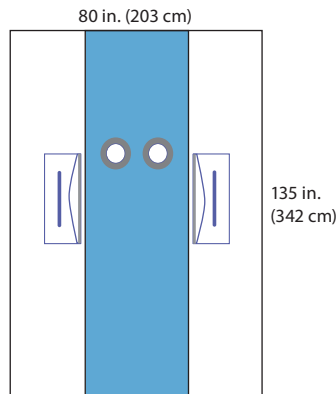

- Absorbent central panel, 29 x 135 in. (74 x 342 cm)
- Apertures, 3.5 in. dia. (9 cm dia.)
- Clear side panels
- Dual side pouches, 11 x 30 in. (28 x 76 cm)

**Femoral Angiography Drape with Dual Pouches**

Sterile No.	Nonsterile No.	Qty. Cs
29521	29521NA	10

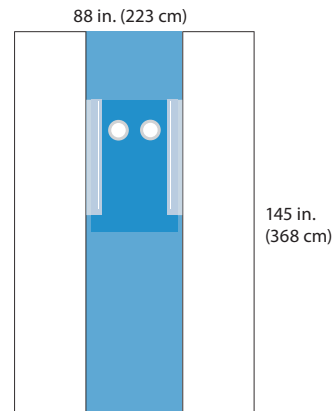

- Absorbent reinforcement, 32 x 50 in. (81 x 127 cm)
- Fenestration, dual circular, 6 in. (15 cm), with circular incise aperture, 3.5 in. (9 cm)
- Clear side panels
- Clear pouches on patient left and right side, 44 x 7½ in. (112 x 19 cm)

# Surgical Drapes and Packs

## Angiography

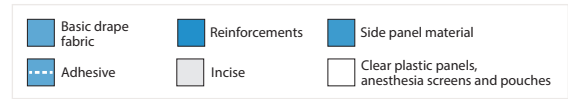

### Angiography Sheet

Sterile No.	Nonsterile No.	Qty. Cs
N/A	D2265NSC	N/A

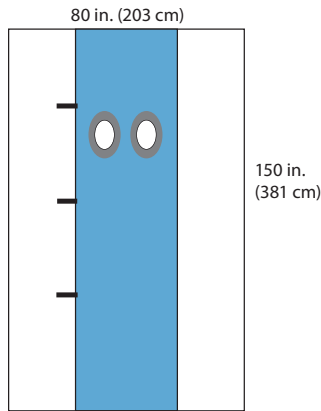

- Absorbent central panel, 29 x 150 in. (74 x 381 cm)
- Apertures, 3.5 x 4.5 in. (9 x 11 cm)
- Clear side panels
- Malleable bars on right panel

### Extra Large Femoral Angiography Drape

Sterile No.	Nonsterile No.	Qty. Cs
29570	29570NA	8

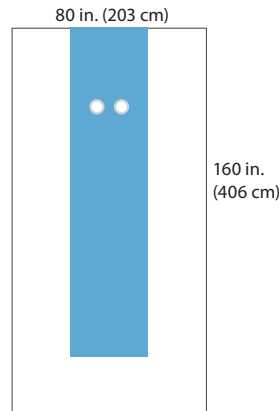

- Absorbent reinforcement, 33.5 x 135 in. (85 x 343 cm)
- Fenestration, dual circular, 6 in. (15 cm), with circular incise aperture, 3.5 in. (9 cm)
- Clear side panels
- Clear foot panel

### Brachial Angiography Drape

Sterile No.	Nonsterile No.	Qty. Cs
29458	29458N	40

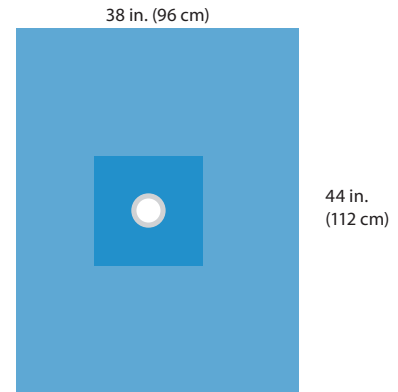

- Absorbent reinforcement, 18 x 20 in. (46 x 51 cm)
- Fenestration, circular incise aperture, 4 in. (10 cm)

### Radial/Brachial Drape

Sterile No.	Nonsterile No.	Qty. Cs
D2364	N/A	20

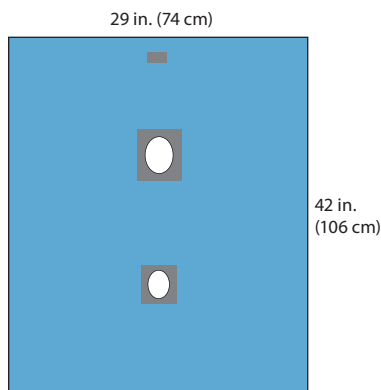

- Absorbent drape material
- Radial aperture, 2 x 3 in. (5 x 7.6 cm)
- Brachial aperture, 2.5 x 3.5 in. (6 x 9 cm)
- Adhesive tab, 2 x 1 in. (5 x 2.5 cm)

### Radial/Brachial Drape

Sterile No.	Nonsterile No.	Qty. Cs
D2422	N/A	20

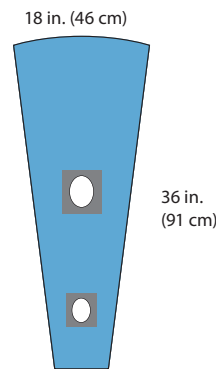

- Absorbent drape material
- Radial aperture, 2 x 3 in. (5 x 7.6 cm)
- Brachial aperture, 2.5 x 3.5 in. (6 x 9 cm)

### Brachial Angiography Drape

Sterile No.	Nonsterile No.	Qty. Cs
29461	N/A	10

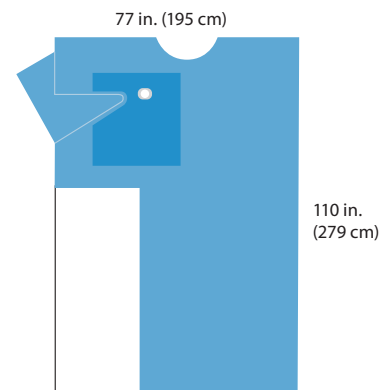

- Absorbent reinforcement, 28 x 29 in. (71 x 73 cm)
- Fenestration, oval with aperture incise, 4.5 x 3.5 in. (11 x 9 cm)
- Clear side panel on patient's right side
- Armboard cover on patient's right side only
- Clipping tabs by fenestration

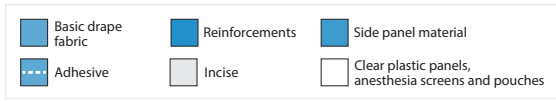

**Radial/Femoral Angiography Drape**

Sterile No.	Nonsterile No.	Qty. Cs
29529	29529NA	12

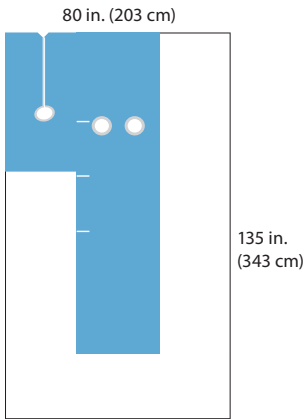

- Absorbent reinforcement
- Fenestration, dual circular, 6 in. (15 cm), with circular incise aperture, 3.5 in. (9 cm)
- Radial access on patient right, 2 x 3 in. (5 x 7.5 cm) oval incise aperture
- Clear side and foot panels
- Malleable bars

**Radial/Femoral Angiography Sheet**

Sterile No.	Nonsterile No.	Qty. Cs
N/A	C2433NS	20

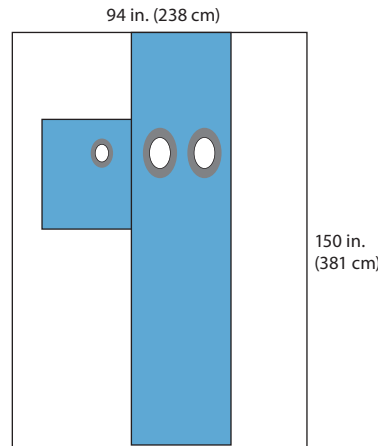

- Absorbent central panel, 29 x 150 in. (74 x 381 cm)
- Absorbent radial reinforcement
- Femoral apertures, 3.5 in. x 4.5 in. (8 cm x 11 cm)
- Radial aperture, 2.5 in. x 3.5 in. (6 cm x 9 cm)
- Clear side panels

**Moveable Radial/Femoral Angio Sheet**

Sterile No.	Nonsterile No.	Qty. Cs
D2399	D2399NS	20

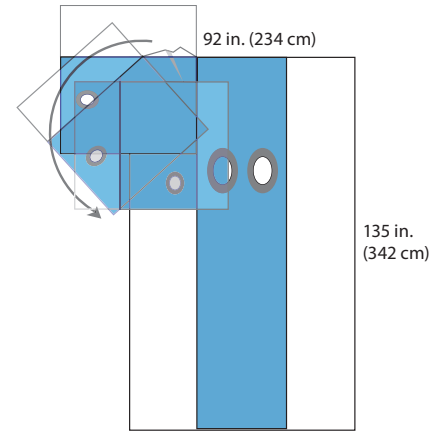

- Absorbent central panel, 29 x 135 in. (74 x 342 cm)
- Absorbent reinforcement on moveable radial extension
- Femoral apertures, 3.5 x 4.5 in. (9 x 11 cm)
- Radial aperture, 2.5 x 3.5 in. (6 x 9 cm)
- Clear side panels

**Lulu Radial/Femoral Angio Sheet**

Sterile No.	Nonsterile No.	Qty. Cs
D2344	D2344NS	20

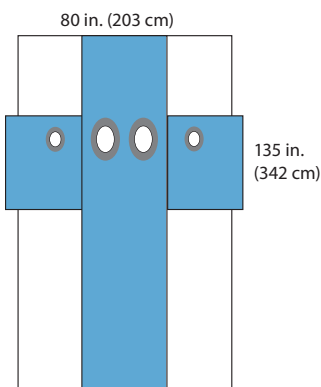

- Absorbent central panel, 29 x 135 in. (74 x 342 cm)
- Radial width, 88.75 in. (225 cm)
- Femoral apertures, 3.5 x 4.5 in. (9 x 11 cm)
- Radial apertures, 2.5 x 3.5 in. (6 x 9 cm)
- Clear side panels

**Lulu Radial/Femoral Angio Sheet**

Sterile No.	Nonsterile No.	Qty. Cs
D2366	D2366NS	20

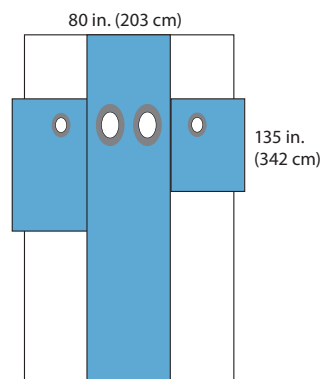

- Absorbent central panel, 29 x 135 in. (74 x 342 cm)
- Radial width, 88.75 in. (225 cm)
- Radial aperture, 2.5 x 3.5 in. (6 x 9 cm)
- Femoral apertures, 3.5 x 4.5 in. (9 x 11 cm)
- Clear side panels

**Orlando Radial/Femoral Angio Sheet**

Sterile No.	Nonsterile No.	Qty. Cs
D2355	D2355NS	20

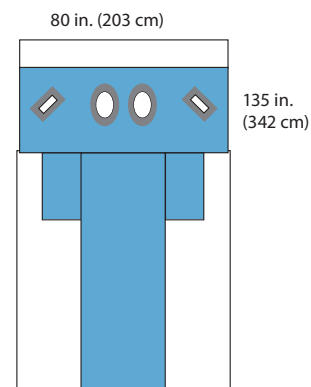

- Absorbent central panel, 29 x 135 in. (74 x 342 cm)
- Additional absorbent pads on right and left side
- Radial width, 86 in. (218 cm)
- Femoral apertures, 3.5 x 4.5 in. (9 x 11 cm)
- Radial apertures, 2.5 x 6 in. (6 x 15 cm)
- Clear side panels

# Surgical Drapes and Packs

## Angiography

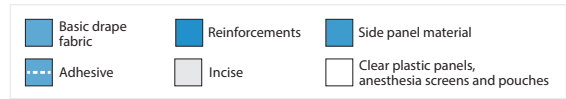

### Multiaccess IR Sheet

Sterile No.	Nonsterile No.	Qty. Cs
C2411*	C2411NS	20

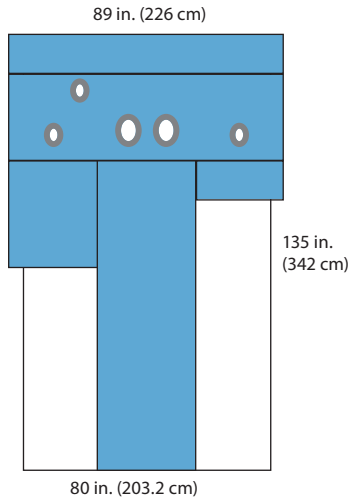

- Absorbent central panel, 29 x 135 in. (74 x 342 cm)
- Femoral apertures, 3.5 x 4.5 in. (9 x 11 cm)
- Radial apertures, 2.5 x 3.5 in. (6 x 9 cm)
- Brachial aperture, 2.5 x 3.5 in. (6 x 9 cm)
- Clear side panels

### Moveable Multiaccess IR Sheet

Sterile No.	Nonsterile No.	Qty. Cs
C2444*	N/A	20

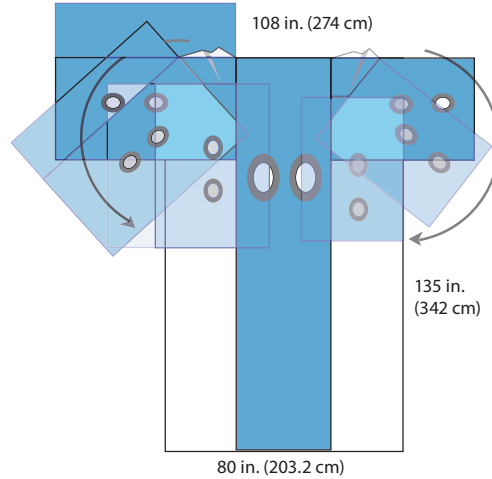

- Absorbent central panel, 29 x 135 in. (74 x 342 cm)
- Femoral apertures, 3.5 x 4.5 in. (9 x 11 cm)
- Radial apertures, 2.5 x 3.5 in. (6 x 9 cm)
- Brachial aperture, 2.5 x 3.5 in. (6 x 9 cm)
- Clear side panels

\*Denotes a 6-8 week lead time.



**Surgical Drapes and Packs**

# Cardiovascular

# Surgical Drapes and Packs

## Cardiovascular

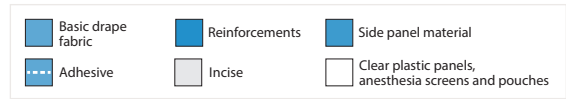

### Cardiovascular Split Drape with Troughs

Sterile No.	Nonsterile No.	Qty. Cs
9163	9163N	8

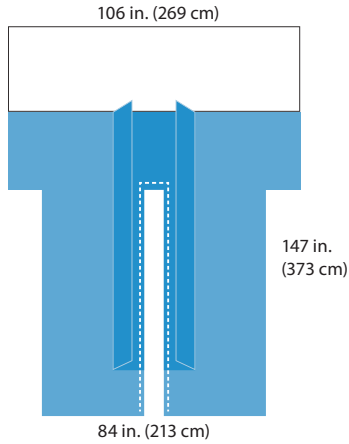

- Absorbent reinforcement
- Split with adhesive, 7 x 88 in. (18 x 223 cm)
- Armboard covers
- Clear anesthesia screen
- Instrument trough
- Included in pack 29163

### Cardiovascular Split Drape

Sterile No.	Nonsterile No.	Qty. Cs
9157	9157N	8

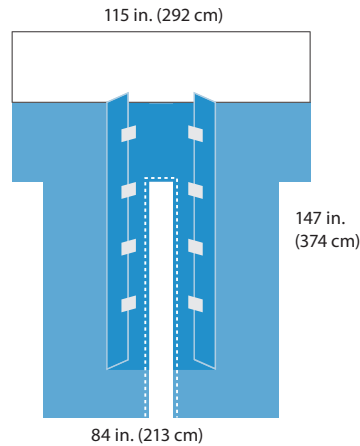

- Absorbent reinforcement, 30 x 42 in. (76.2 x 106.7 cm)
- Splits with adhesive, 7 x 88 in. (18 x 223.5 cm)
- Armboard covers
- Clear anesthesia screen
- Instrument troughs with Velcro®

### Cardiovascular Split Drape with Pouches

Sterile No.	Nonsterile No.	Qty. Cs
9155	9155NA	12

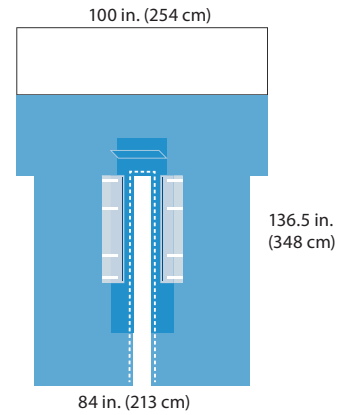

- Absorbent reinforcement, 10 x 57.5 in. (25.4 x 146 cm) (sides) and 20 x 15 in. (51 x 38 cm) (top)
- Split with adhesive, 7 x 81 in. (18 x 206 cm)
- Armboard covers
- Clear anesthesia screen
- Clear pouches on patient right and left, 40 x 18 in. (102 x 46 cm)
- Clipping tab

### Cardiovascular Split Drape

Sterile No.	Nonsterile No.	Qty. Cs
29154	29154N	8

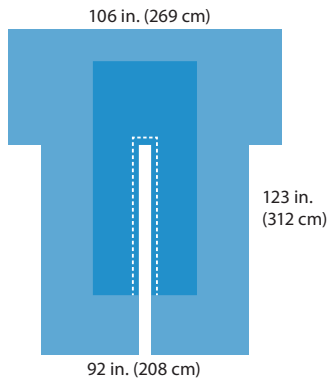

- Absorbent reinforcement
- Split with adhesive, 5 x 80 in. (13 x 203 cm)
- Armboard covers

### Cardiovascular Peri-Groin Drape

Sterile No.	Nonsterile No.	Qty. Cs
9154	9154N	10

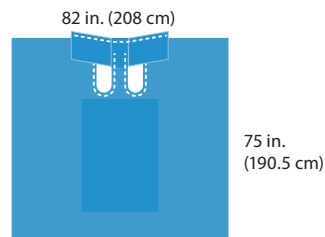

- Absorbent reinforcement, 30 x 42 in. (76 x 106 cm)
- Splits, dual with adhesive, 6 x 20 in. (15 x 51 cm)
- Attached groin sheet, 36 x 11 in. (91 x 28 cm)
- Included in pack 29158

### Cardiovascular Incise Drape

Sterile No.	Nonsterile No.	Qty. Cs
9156	9156N	7

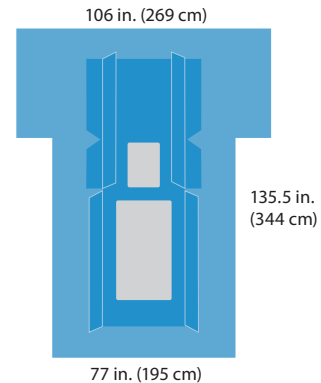

- Non-absorbent reinforcement
- Fenestration, chest incise, 18 x 22 in. (46 x 56 cm)
- Fenestration, leg incise, 28 x 45 in. (71 x 114 cm)
- Armboard covers
- Clipping tabs



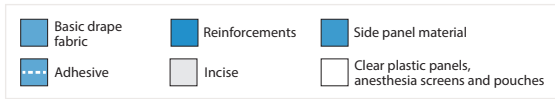

### Cardiovascular Incise Drape

Sterile No.	Nonsterile No.	Qty. Cs
9162	9162N	7

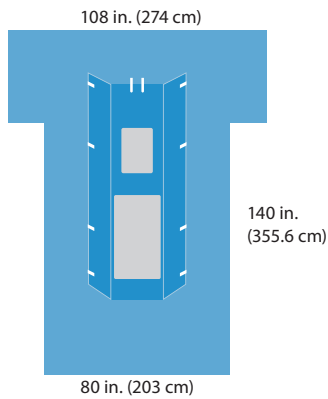

- Absorbent reinforcement, 42 x 88 in. (107 x 223 cm)
- Fenestration, chest incise, 14 x 18 in. (25.5 x 46 cm)
- Fenestration, leg incise, 24 x 41 in. (61 x 104 cm)
- Armboard covers
- Instrument troughs, 8 x 88 in. (20 x 223 cm)
- Velcro® Tabs

### Cardiovascular Drape

Sterile No.	Nonsterile No.	Qty. Cs
N/A	9150N	N/A

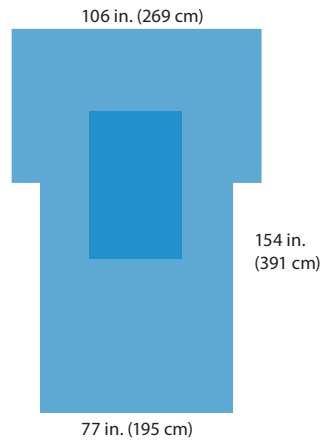

- Absorbent foam reinforcement, 38.5 x 60 in. (98 x 152 cm)
- Non-fenestrated
- Armboard covers
- Included in pack 9150

### Head, Side and Foot Drapes

Sterile No.	Nonsterile No.	Qty. Cs
N/A	29462N	N/A
N/A	29467NB	N/A
N/A	29468N	N/A

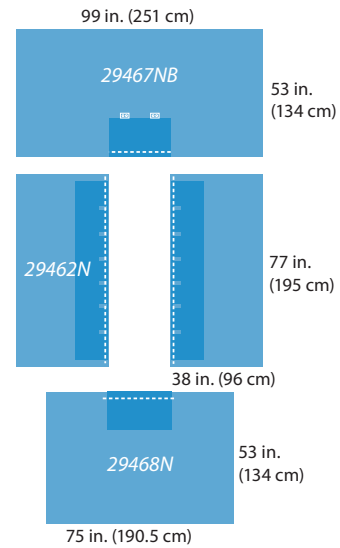

- Absorbent reinforcement
- Fabric loop cord-holding tabs
- Included in pack 29153

### Bottom Drape with Reinforcement

Sterile No.	Nonsterile No.	Qty. Cs
N/A	29464N	N/A

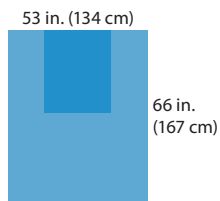





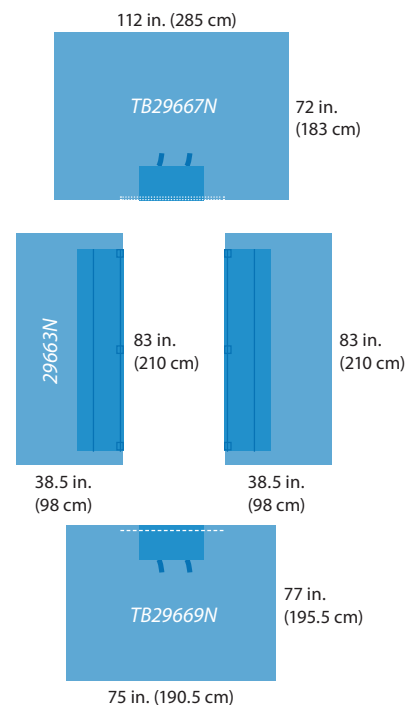

- Absorbent reinforcement, 26 x 30 in. (66 x 76 cm)

### CV Universal Drape Pack

Sterile No.	Nonsterile No.	Qty. Cs
9153	9153N	5
N/A	TB29667N	N/A
N/A	29663N	N/A
N/A	TB29669N	N/A

- Absorbent troughs on side sheets with Velcro® Closures
- Velcro® Cord-Holding Tabs on head and foot sheet



 Basic drape fabric	 Reinforcements	 Side panel material
 Adhesive	 Incise	 Clear plastic panels, anesthesia screens and pouches

## Cardiovascular Packs







Nonsterile No.	Description	9150 Cardiovascular Pack	9153 Cardiovascular Universal Pack	29153 Cardiovascular Pack with reinforced Gowns	29163 Cardiovascular Split Pack II
9150N	Cardiovascular Drape	1			
29467NB	Head Drape, 99 x 53 in. (251 x 134.6 cm), adhesive, absorbent reinforcement			1	
29462N	Side Drape, 38 x 77 in. (96 x 195 cm), adhesive, absorbent reinforcement			2	
29468N	Foot Sheet, 75 x 53 in. (190 x 134.6 cm), adhesive, absorbent reinforcement			1	
9349NB	Three-Quarter Drape Sheet, 52 x 76 in. (132 x 193 cm)	1			1
TB29667N	Head Drape, 112 x 72 in. (285 x 183 cm), adhesive, absorbent reinforcement		1		
29663N	Side Sheet, 38.5 x 83 in. (98 x 210 cm) with absorbent troughs and Velcro® Closures		2		
TB29669N	Foot Drape, 75 x 77 in. (190.5 x 195.5 cm), adhesive, absorbent reinforcement		1		
9154N	Cardiovascular Peri-Groin Drape				1
9163N	Cardiovascular Split Drape II				1
29464N	Bottom Drape with reinforcement			1	
9541NA	AAMI 3 Fabric Reinforced Surgical Gown, X-Large	3			
9040NB	AAMI 4 Poly Reinforced Surgical Gown, X-Large			2	2
90780NB	AAMI 4 Poly Reinforced Scrub Nurse Gown, X-Large, includes towel and wrap			1	
90680NB	AAMI 4 Poly Reinforced Scrub Nurse Gown, Large				1
8520N	Absorbent towel	2		1	
7554NA	Drape Towel with adhesive strip, 19 x 30 in. (48 x 76 cm)				8
8694-61	Suture bag	1		1	1
8337N	Mayo stand cover, reinforced poly, 23 x 55 in. (58 x 140 cm)	1			1
8188NC	Overhead table cover, 80 x 90 in. (203 x 228.6 cm), reinforced poly with a 44 x 72 in. (112 x 183 cm) fabric sterile field extension, SMS reinforcement, 40 x 90 in. (101.6 x 228.6 cm)			1	
8554NA	Non-absorbent drape towel with adhesive strip, 15 x 26 in. (38 x 66 cm)	6		6	
9460	Peri-towel			1	
8470	Plastic sheet, 50 x 59 in. (127 x 150 cm)			1	
8152N	Heavy-duty back table cover, 80 x 110 in. (203 x 279 cm), SMS reinforcement, 37 x 110 in. (94 x 279 cm)				1
8143N	Standard back table cover, 50 x 90 in. (127 x 228.6 cm), SMS reinforcement, 29 x 90 in. (73.6 x 228.6 cm)	1		1	
<b>Quantity per case</b>		<b>4</b>	<b>5</b>	<b>3</b>	<b>3</b>



**Surgical Drapes and Packs**

# Central Line

# Central Line

 Basic drape fabric	 Reinforcements	 Side panel material
 Adhesive	 Incise	 Clear plastic panels, anesthesia screens and pouches

## Central Line Drape

Sterile No.	Nonsterile No.	Qty. Cs
C2324	C2324NS	30

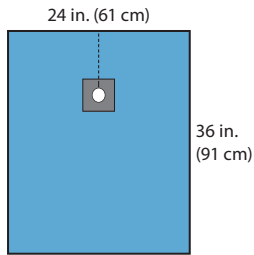

- Aperture, 4 in. dia. (10 cm dia.)
- Perforated fenestration slit for easy removal

## Central Line Sheet

Sterile No.	Nonsterile No.	Qty. Cs
C2346	C2346NS	20

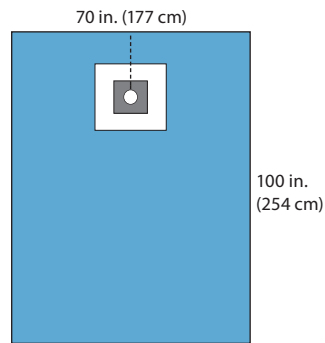

- Aperture, 4 in. dia. (10 cm dia.)
- Perforated fenestration slit for easy removal

## Full Body Central Line Drape

Sterile No.	Nonsterile No.	Qty. Cs
29527	29527N	14

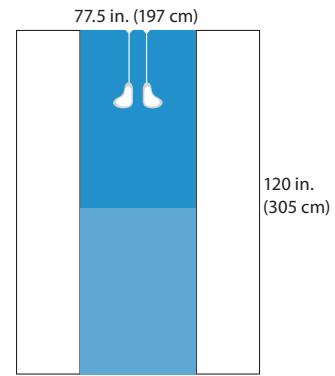

- Absorbent reinforcement, 36 x 57.5 in. (91 x 146 cm)
- Fenestrations with incise aperture allow for intrajugular or subclavian access
- Clear side panels
- Easy removal feature on both fenestrations

## Jugular Sheet

Sterile No.	Nonsterile No.	Qty. Cs
C2315	C2315NS	20

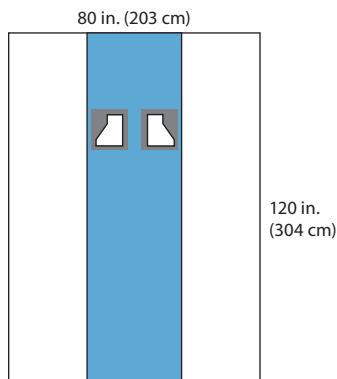

- Absorbent central panel, 29 x 120 in. (74 x 304 cm)
- Clear side panels
- Apertures, 6 x 8 in. (15 x 20 cm)

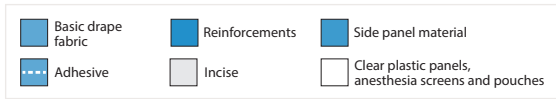

### PICC Line Insertion Drape

Sterile No.	Nonsterile No.	Qty. Cs
29668	29668N	10

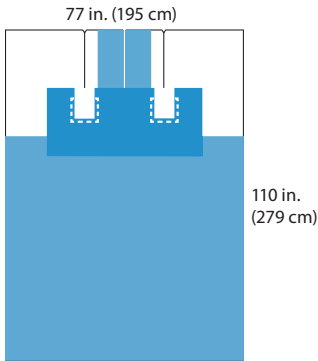

- Absorbent reinforcement, 52 x 27 in. (132 x 51 cm)
- Fenestration with adhesive, dual for right or left side line placement, 6 x 4 in. (15 x 10 cm)
- Notch at top center of drape allows user to create an opening to expose patient's face

### Line Insertion Draping System

Sterile No.	Nonsterile No.	Qty. Cs
29559	29559N	10

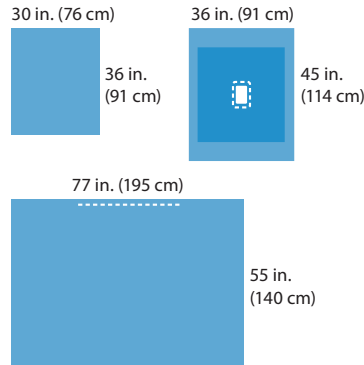

- Absorbent reinforcement, 30.5 x 30.5 in. (77.5 x 77.5 cm)
- Fenestration with adhesive, 4 x 6 in. (10 x 15 cm)
- Three-part draping system with prep pad, fenestrated drape and extension drape

### Line Insertion Drape

Sterile No.	Nonsterile No.	Qty. Cs
N/A	29557N	N/A

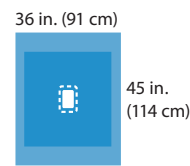

- Absorbent, reinforcement, 30.5 x 30.5 in. (77.5 x 77.5 cm)
- Fenestration with adhesive, 4 x 6 in. (10 x 15 cm)

### Dressing Change Pouch Organizer

Sterile No.	Nonsterile No.	Qty. Cs
N/A	2058N	N/A

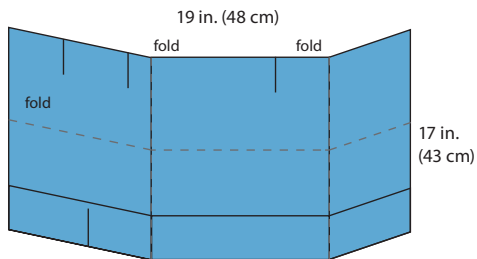

- Eight total pockets in organizer to allow for placement of dressing change supplies
- Four pockets on external fold
- Four pockets on internal fold

**Surgical Drapes and Packs**

# Cystoscopy

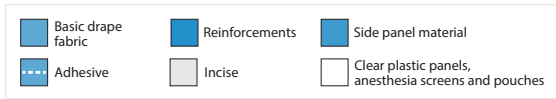

### Cystoscopy "T" Drape

Sterile No.	Nonsterile No.	Qty. Cs
N/A	29437NB	N/A

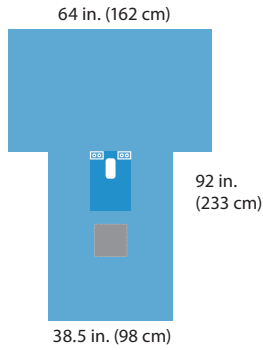

- Absorbent reinforcement, 13.375 x 20.625 in. (34 x 52.5 cm)
- Fenestration, 3 x 6 in. (7.5 x 15 cm)
- Mesh screen, 10 x 10 in. (25 x 25 cm)
- Cord-holding tabs
- Included in packs 29470, 29471, 29480

### Urological Drape

Sterile No.	Nonsterile No.	Qty. Cs
N/A	29451N	N/A

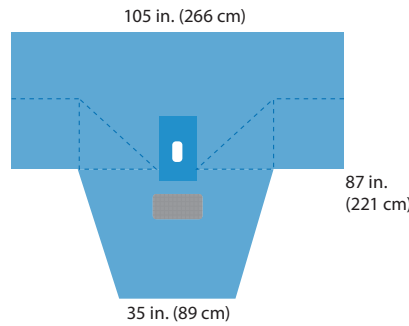

- Absorbent reinforcement, 12 x 19 in. (30.5 x 48 cm)
- Fenestration, 3 x 6 in. (7.5 x 15 cm)
- Mesh screen, 14 x 8 in. (35.5 x 20 cm)
- Attached leggings
- Cord-holding tabs
- Included in pack 29360

### Lithotomy Drape with Fluid Control Pouch

Sterile No.	Nonsterile No.	Qty. Cs
29455	29455NA	8

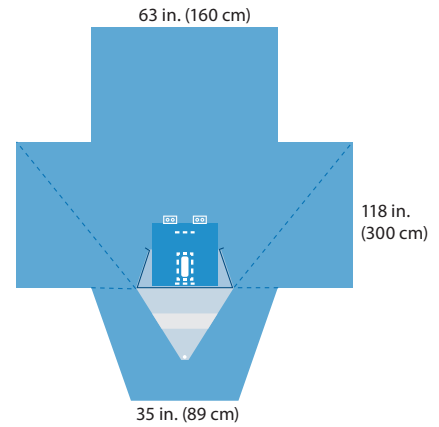

- Absorbent reinforcement, 20 x 19 in. (51 x 48 cm)
- Fenestration with adhesive, 2.5 x 6.5 in. (6 x 16.5 cm)
- Anesthesia screen
- Attached leggings
- Fluid control pouch with filtering screen, closed suction port, drawstring feature and side trough, 22¾ x 34½ in. (58 x 88 cm)
- Cord-holding tabs

### Urological Drape

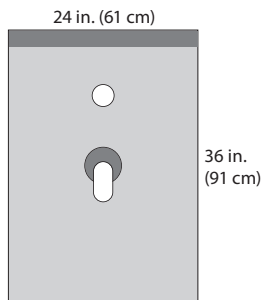

Sterile No.	Nonsterile No.	Qty. Cs
D1071	D1071NS	10

- Adhesive, 24 x 2.7 in. (61 x 7 cm)
- Aperture, 1 in. dia. (2.5 cm dia.)
- Finger Cot Adhesive, 4 in. dia. (10 cm dia.)

### Cystoscopy Packs

Nonsterile No.	Description	29470 Cystoscopy Pack	29471 Cystoscopy Pack	29480 Cystoscopy Pack	29360 Cystoscopy Pack	9520E Cystoscopy Pack
29437NB	Cysto T-drape, absorbent reinforcement	1	1	1		
29451N	Urological drape with absorbent reinforcement, attached leggings				1	
9461N	Drape Sheet, square-folded, 38.5 x 38.5 in. (98 x 98 cm)					2
9515NB	AAMI 3 NonReinforced Surgical Gown, Large	1				
32474NA	AAMI 4 Breathable Surgical Gown, X-Large, X-Long, Specialty		1			
8694-61	Suture bag	1	1	1	1	1
8520N	Absorbent towel	1	1	1	1	
8421NB	Pair of leggings, X-Large	1	1	1		1
8145N	Outer wrap/reinforced poly table cover 44 x 75 in. (112 x 190 cm), reinforcement 24 x 75 in. (61 x 190 cm)	1	1	1	1	1
<b>Quantity per case</b>		<b>10</b>	<b>8</b>	<b>14</b>	<b>10</b>	<b>10</b>



General Surgery

Surgical Drapes and Packs

# General Surgery



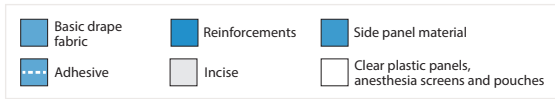

### Universal Drape Side-Sheet

Sterile No.	Nonsterile No.	Description	Qty. Cs
N/A	29565N	38 x 77 in. (96 x 195 cm), cord holding tabs	35

### Setup Packs

Nonsterile No.	Description	114 Setup Pack	117 Setup Pack	119 Orthopedic Setup Pack	9102 Basic Pack
8554NA	Drape towel, adhesive, nonabsorbent		4	4	
8337N	Mayo Stand Cover, reinforced poly, 23 in. (58 cm) wide	1	1	1	1
8694-61	Suture bag	1	1	1	1
8476NA	U-Drape, poly, adhesive, 60 x 72 in. (152 x 183 cm), 6 x 21 in. (15 x 53 cm) split			1	
1582NB	Stockinette, 12 x 48 in. (30 x 122 cm), X-Large			1	
3524N	Drape Tape			4	
8146N	Outer wrap, reinforced poly table cover, 44 x 90 in. (112 x 228 cm)	1			
8143N	Outer wrap, reinforced poly table cover, 50 x 90 in. (127 x 228 cm)		1		
8186NA	Outer wrap, reinforced poly table cover, 60 x 90 in. (152 x 228 cm), heavy-duty			1	1
<b>Quantity per case</b>		<b>12</b>	<b>13</b>	<b>4</b>	<b>12</b>

### Basic Packs

Nonsterile No.	Description	9100 Basic Pack	9101 Basic Pack	9103 Basic Pack	9111 Basic Pack	9112 Basic Pack	9113 Basic Pack	9114 Basic Pack	9131 Basic Pack
8520N	Absorbent towel				1		1	1	
8694-61	Suture bag	1	1	1	1	1	1	1	1
8337N	Mayo stand cover, reinforced poly, 23 in. (58 cm) wide	1	1	1	1	1	1	1	1
8554NA	Drape towel, adhesive, nonabsorbent	4		4	4	4	4	4	
9358NB	Fan-folded Drape Sheet, 40 x 57 in. (101 x 145 cm)	1		1					
9439NB	Fan-folded Drape Sheet, 52 x 76 in. (132 x 193 cm)	1		1	1	1	1	1	
90270NB	AAMI 3 NonReinforced Scrub Nurse Gown, Large, with towel and wrap		1	1			1		1
9515NB	AAMI 3 NonReinforced Surgical Gown, Large		1	1			1		1
90970NA	AAMI 3 Fabric Reinforced Scrub Nurse Gown, Large, with towel and wrap				1				
9511NB	AAMI 3 Fabric Reinforced Surgical Gown, Large				1				
9010NB	AAMI 4 Poly Reinforced Surgical Gown, Large							1	
90680NB	AAMI 4 Poly Reinforced Scrub Nurse Gown, Large							1	
8143N	Outer wrap, reinforced poly table cover, 50 x 90 in. (127 x 228 cm)							1	
8146N	Outer wrap, reinforced poly table cover, 44 x 90 in. (112 x 228 cm)	1	1	1	1	1	1		
8186NA	Outer wrap, reinforced poly table cover, 60 x 90 in. (152 x 228 cm), heavy-duty								1
<b>Quantity per case</b>		<b>12</b>	<b>5</b>	<b>8</b>	<b>5</b>	<b>10</b>	<b>5</b>	<b>5</b>	<b>7</b>

# Surgical Drapes and Packs

## General Surgery

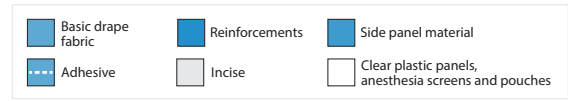

### Universal Pack

Sterile No.	Nonsterile No.
N/A	9467N
N/A	9465N
N/A	9468N

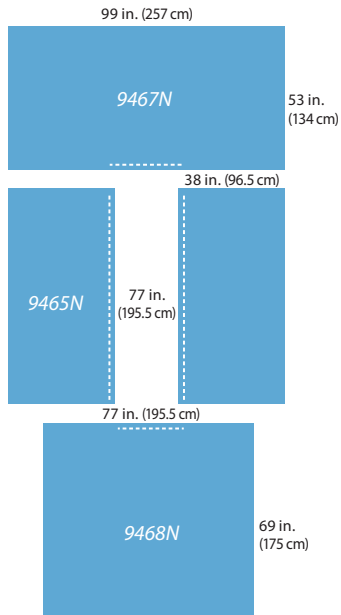

### Universal Pack

Sterile No.	Nonsterile No.
N/A	29467NB
N/A	29465NB
N/A	29469N

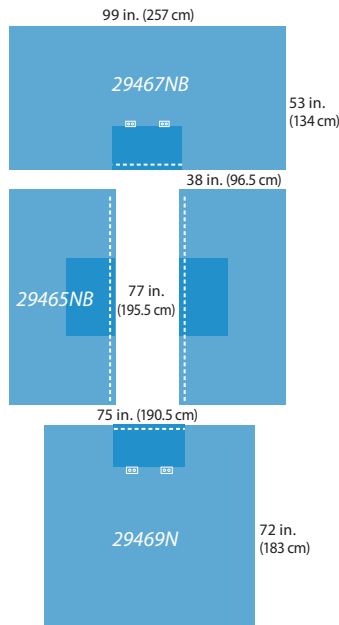

### Universal Pack

Sterile No.	Nonsterile No.
N/A	29667N
N/A	29665N
N/A	29669N

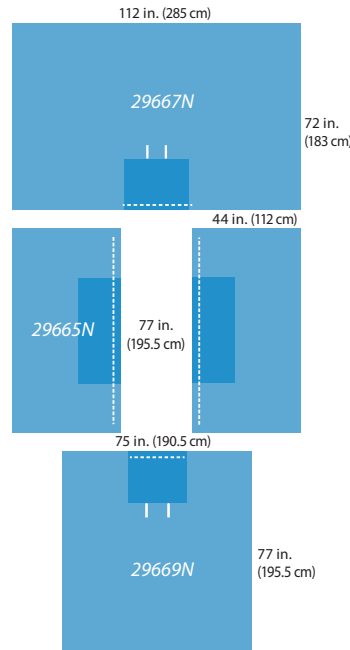

### Universal Pack

Sterile No.	Nonsterile No.
N/A	TB29667N
N/A	TB29665N
N/A	TB29669N

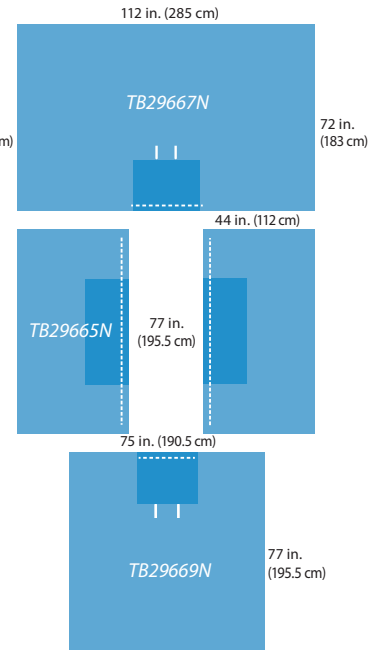

- Included in pack 9106

- Absorbent reinforcement with adhesive
- Cord-holding tabs
- Included in pack 29107

- Absorbent reinforcement with adhesive
- Cord-holding straps
- Included in pack 29118

- Absorbent base drape fabric
- Absorbent reinforcement with adhesive
- Cord-holding straps
- Included in pack TB29118

### Universal Split Pack

Sterile No.	Nonsterile No.	Qty. Cs
29352	29351NC	14
29440	29440NC	10

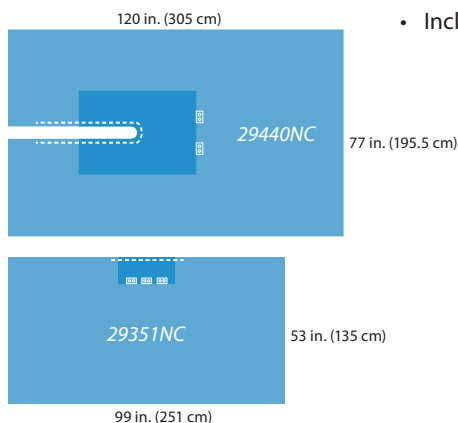





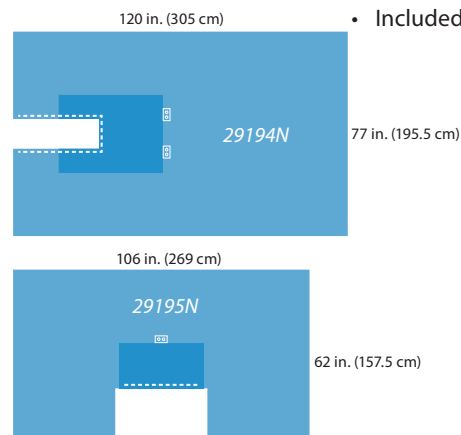

- Absorbent reinforcement
- Split, 6 x 46 in. (15 x 117 cm) on 29440NC
- Cord-holding tabs
- Included in pack 29131

### Universal Split Pack

Sterile No.	Nonsterile No.
N/A	29195N
N/A	29194N



- Absorbent reinforcement
- Split, 12 x 30 in. (30.5 x 76 cm) on 29194N
- Cord-holding tabs
- Included in pack 29133

 Basic drape fabric	 Reinforcements	 Side panel material
 Adhesive	 Incise	 Clear plastic panels, anesthesia screens and pouches

### Universal Packs

Nonsterile No.	Description	9106 Universal Pack	29107 Universal Pack	29118 Universal Pack	TB29118 Universal Pack, SFS	29131 Universal Split Pack	29133 Universal Split Pack II
9465N	Side Drape, 38 x 77 in. (96.5 x 195.5 cm), adhesive	2					
9468N	Foot Drape, 77 x 69 in. (195.5 x 175 cm), adhesive	1					
9467N	Head Drape, 99 x 53 in. (251 x 134 cm), adhesive	1					
29465NB	Side Drape, 38 x 77 in. (96.5 x 195.5 cm), adhesive, absorbent reinforcement		2				
29469N	Foot Drape, 75 x 72 in. (190.5 x 183 cm), adhesive, absorbent reinforcement		1				
29467NB	Head Drape, 99 x 53 in. (251 x 134 cm), adhesive, absorbent reinforcement		1				
29440NC	Split Drape with absorbent reinforcement					1	
29351NC	Top Drape, absorbent reinforcement					1	
29669N	Foot Drape, 75 x 77 in. (190.5 x 195.5 cm), adhesive, absorbent reinforcement			1			
29667N	Head Drape, 112 x 72 in. (285 x 183 cm), adhesive, absorbent reinforcement			1			
29665N	Side Drape, 44 x 77 in. (112 x 195.5 cm), adhesive, absorbent reinforcement			2			
TB29667N	Head Drape, 112 x 72 in. (285 x 183 cm), adhesive, absorbent reinforcement				1		
TB29665N	Side Drape, 44 x 77 in. (112 x 195.5 cm), adhesive, absorbent reinforcement				2		
TB29669N	Foot Drape, 75 x 77 in. (190.5 x 195.5 cm), adhesive, absorbent reinforcement				1		
29194N	Chest/Breast Drape						1
29195N	Bar Drape with armboard covers						1
90270NB	AAMI 3 NonReinforced Scrub Nurse Gown, Large, with towel and wrap		1				
9515NB	AAMI 3 Nonreinforced Surgical Gown, Large		1				
8520N	Absorbent towel	1	1	1	1		
8554NA	Drape towel, adhesive, nonabsorbent		4	4	4	4	4
8337N	Mayo stand cover, reinforced poly, 23 in. (58 cm) wide	1	1	1	1	1	1
8694-61	Suture bag	1	1	1	1	1	1
8146N	Outer wrap, reinforced poly table cover, 44 x 90 in. (112 x 228.6 cm)	1	1	1	1		
8143N	Outer wrap, reinforced poly table cover, 50 x 90 in. (127 x 228.6 cm)					1	1
<b>Quantity per case</b>		<b>5</b>	<b>6</b>	<b>6</b>	<b>6</b>	<b>4</b>	<b>10</b>

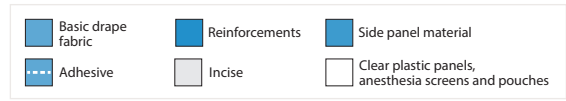

### Laparotomy Drape

Sterile No.	Nonsterile No.	Qty. Cs
29410	29410NC	12

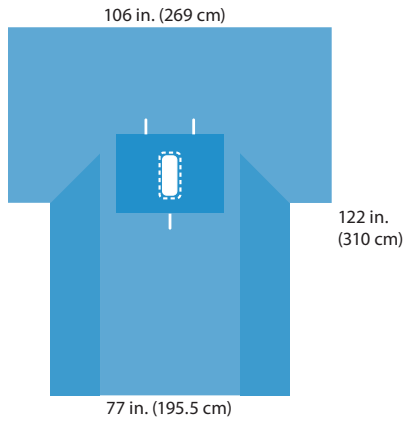

- Absorbent reinforcement, 30.5 x 30.5 in. (77.5 x 77.5 cm)
- Fenestration, 4 x 12 in. (10 x 30.5 cm)
- Armboard covers
- Velcro® Cord-Holding Tabs
- Included in packs 29127, 29130, 29137, 29138, 29140

### Laparotomy Drape

Sterile No.	Nonsterile No.	Qty. Cs
29411	N/A	9

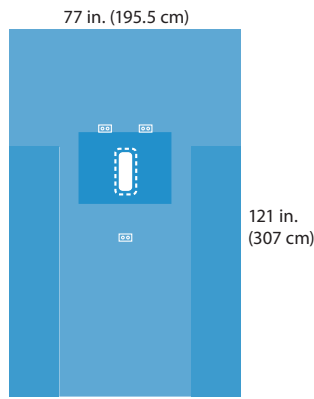

- Absorbent reinforcement, 30.5 x 30.5 in. (77.5 x 77.5 cm)
- Fenestration, 4 x 12 in. (10 x 30.5 cm)
- Cord-holding tabs
- Included in pack 29120

### Transverse Laparotomy Drape

Sterile No.	Nonsterile No.	Qty. Cs
29421	29421NB	12

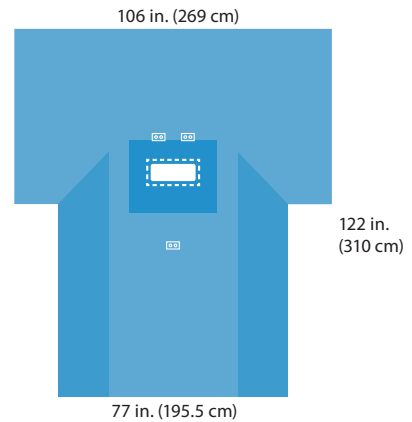

- Absorbent reinforcement, 30.5 x 30.5 in. (77.5 x 77.5 cm)
- Fenestration, 14 x 4 in. (35.5 x 10 cm)
- Armboard covers
- Cord-holding tabs
- Included in pack 29121

### Laparotomy Incise Drape

Sterile No.	Nonsterile No.	Qty. Cs
29510	29510NB	14

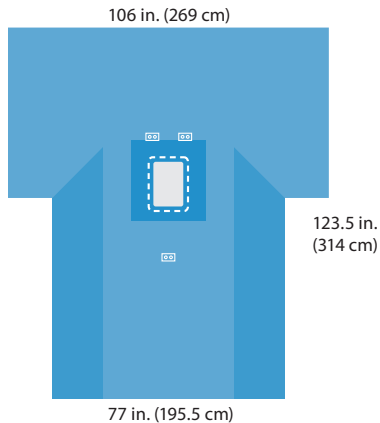

- Absorbent reinforcement, 30.5 x 30.5 in. (77.5 x 77.5 cm)
- Fenestration, full incise, 9 x 14.5 in. (23 x 37 cm)
- Armboard covers
- Cord-holding tabs

### Laparotomy Drape with Pouches

Sterile No.	Nonsterile No.	Qty. Cs
9430	9430NB	12

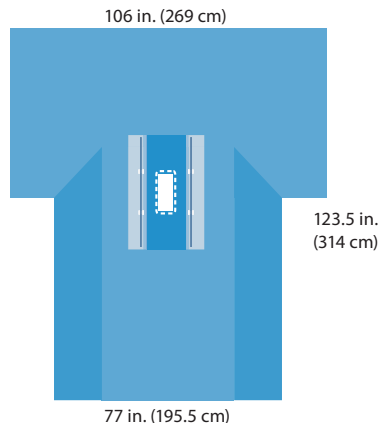

- Absorbent reinforcement, 14 x 38.5 in. (35.5 x 98 cm)
- Fenestration, 4 x 12 in. (10 x 30.5 cm)
- Armboard covers
- Dual clear closed end poly troughs with Velcro® Closures, 8 x 38.5 in (20 x 98 cm)

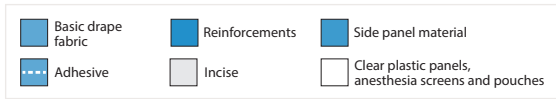

### Minor Procedure Drape

Sterile No.	Nonsterile No.	Qty. Cs
29496	29496NC	10

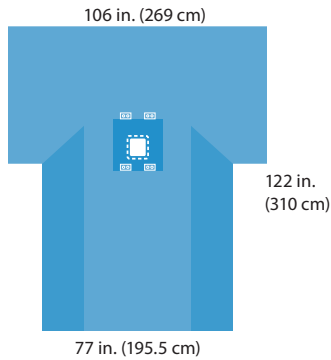

- Absorbent reinforcement, 19 x 19 in. (48 x 48 cm)
- Fenestration, 6 x 6 in. (15 x 15 cm)
- Armboard covers
- Cord-holding tabs

### Adolescent Laparotomy Drape

Sterile No.	Nonsterile No.	Qty. Cs
9418	9418N	10

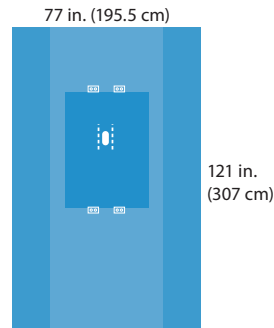

- Absorbent reinforcement, 35 x 44 in. (89 x 112 cm)
- Fenestration, 2.5 x 5.5 in. (6 x 14 cm)
- Cord-holding tabs

### Thyroid Drape

Sterile No.	Nonsterile No.	Qty. Cs
29522	29522NB	12

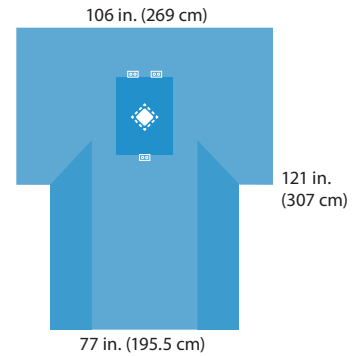

- Absorbent reinforcement, 23.5 x 30 in. (60 x 76 cm)
- Fenestration, diamond, 5 x 5 in. (13 x 13 cm)
- Armboard covers
- Cord-holding tabs

### Thyroid Drape

Sterile No.	Nonsterile No.	Qty. Cs
29422	29422NB	10

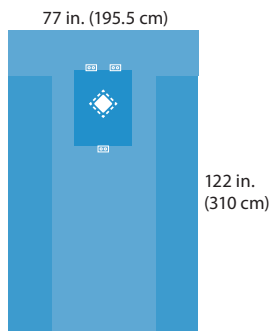

- Absorbent reinforcement, 22 x 30 in. (56 x 76 cm)
- Fenestration, diamond, 5 x 5 in. (13 x 13 cm)
- Cord-holding tabs

### Chest/Breast Drape

Sterile No.	Nonsterile No.	Qty. Cs
29420	29420ND	12

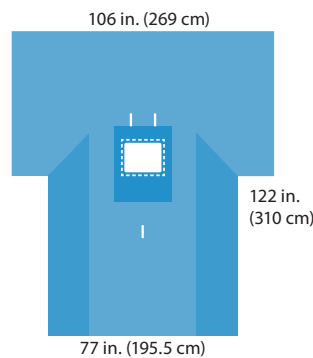

- Absorbent reinforcement, 30.5 x 30.5 in. (77.5 x 77.5 cm)
- Fenestration, 14 x 11 in. (35.5 x 28 cm)
- Armboard covers
- Velcro® Cord-Holding Tabs

### Laparoscopic Cholecystectomy Drape with Pouches

Sterile No.	Nonsterile No.	Qty. Cs
9428	9428NC	8

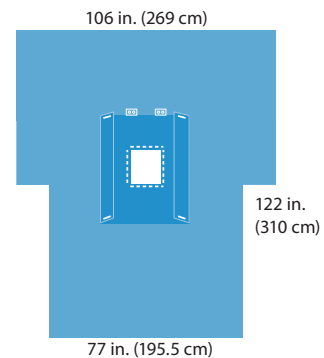

- Absorbent reinforcement, 36 x 42 in. (91 x 107 cm)
- Fenestration, 14 x 11 in. (35.5 x 28 cm)
- Armboard covers
- Velcro® Cord-Holding Tabs
- Trough, 56 x 42 in. (142 x 107 cm)

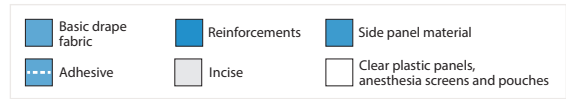

### Laparoscopic Abdominal Drape

Sterile No.	Nonsterile No.	Qty. Cs
9438	9438NB	12

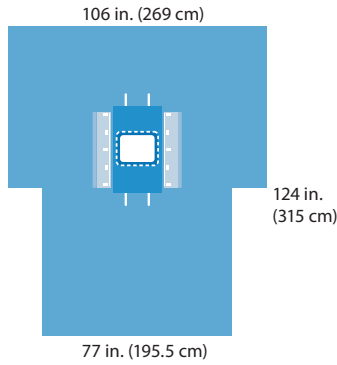

- Absorbent reinforcement, 20 x 35.5 in. (51 x 90 cm)
- Fenestration, 14 x 11 in. (35.5 x 28 cm)
- Armboard covers
- Two separate clear pouches on each side, 10.5 x 30 in. (27 x 76 cm), feature a shared malleable wire
- Velcro® Cord-Holding Tabs

### General Endoscopy Drape

Sterile No.	Nonsterile No.	Qty. Cs
9458	9458NB	12

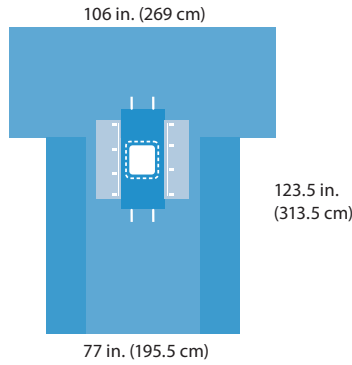

- Absorbent reinforcement, 16 x 38.5 in. (40.5 x 98 cm)
- Fenestration, 10 x 11 in. (25.5 x 28 cm)
- Armboard covers
- Dual clear open ended poly troughs with Velcro® Closure, 11.125 x 30 in. (28 x 76 cm)
- Velcro® Cord-Holding Tabs
- Included in pack 9120

### Bariatric Drape

Sterile No.	Nonsterile No.	Qty. Cs
94590	94590N	8

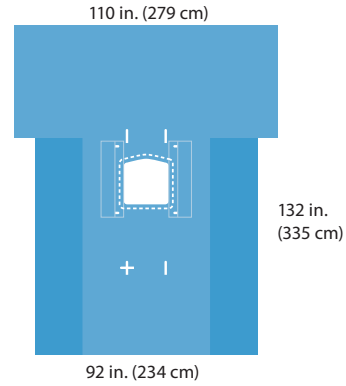

- Fenestration, chevron, 18 x 18 in. (45.5 x 45.5 cm)
- Armboard covers
- Fabric instrument troughs, 28.5 x 24 in. (72 x 61 cm)
- Velcro® Cord-Holding Tabs

### Major Abdominal Drape with Pouches

Sterile No.	Nonsterile No.	Qty. Cs
9457	9457N	12

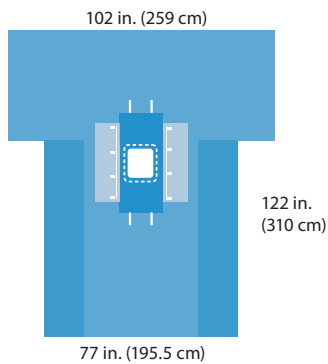

- Absorbent reinforcement, 16 x 38.5 in. (40.5 x 98 cm)
- Fenestration, 10 x 11 in. (25.5 x 28 cm)
- Armboard covers
- Dual clear pouches with Velcro® Closure, 11.125 x 30 in. (28 x 76 cm)
- Velcro® Cord-Holding Tabs

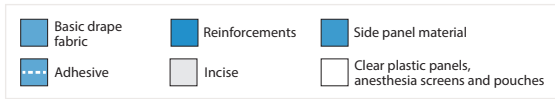

### Laparotomy Packs

Nonsterile No.	Description	29127 Laparotomy Pack	29130 Laparotomy Pack	29137 Laparotomy Pack	29138 Laparotomy Pack	29140 Laparotomy Pack	29120 Laparotomy Pack	29121 Transverse Laparotomy Pack
9358NB	Half Drape, 40 x 57 in. (101 x 145 cm)	2					2	
29410NC	Laparotomy Drape, absorbent reinforcement	1	1	1	1	1		
29411N	Laparotomy Drape, absorbent reinforcement						1	
29421NB	Laparotomy Drape, absorbent reinforcement							1
90680NB	AAMI 4 Poly Reinforced Scrub Nurse Gown, Large		1					
9010NB	AAMI 4 Poly Reinforced Surgical Gown, Large		1					
90270NB	AAMI 3 NonReinforced Scrub Nurse Gown, Large, with towel and wrap					1		1
9515NB	AAMI 3 NonReinforced Surgical Gown, Large					1		1
9511NB	AAMI 3 Fabric Reinforced Surgical Gown, Large	2		2				
8554NA	Drape towel, adhesive, nonabsorbent	4	4	4	4	4	4	4
8520N	Absorbent towel	3	1	2	1		1	1
8337N	Mayo stand cover, reinforced poly, 23 in. (58 cm) wide	1	1	1	1	1	1	1
8694-61	Suture bag	1	1	1	1	1	1	1
8146N	Outer wrap, reinforced poly table cover, 44 x 90 in. (111.7 x 228.6 cm)	1		1	1	1	1	1
8143N	Outer wrap, reinforced poly table cover, 50 x 90 in. (127 x 228.6 cm)		1					
	<b>Quantity per case</b>	<b>6</b>	<b>4</b>	<b>6</b>	<b>10</b>	<b>4</b>	<b>5</b>	<b>6</b>

### General Endoscopy Pack

Nonsterile No.	Description	9120 General Endoscopy Pack
9458NB	General Endoscopy Drape	1
90270NB	AAMI 3 NonReinforced Scrub Nurse Gown, Large, with towel and wrap	1
9515NB	AAMI 3 NonReinforced Surgical Gown, Large	2
8554NA	Drape towel, adhesive, nonabsorbent	4
7148	X-ray detectable sponge, 4 x 4 in. (10 x 10 cm)	10
8337N	Mayo stand cover, reinforced poly, 23 in. (58 cm) wide	1
8694-61	Suture bag	1
8146N	Outer wrap, reinforced poly table cover, 44 x 90 in. (111.7 x 228.6 cm)	1
	<b>Quantity per case</b>	<b>6</b>



**Surgical Drapes and Packs**

# Neurosurgery

Neurosurgery



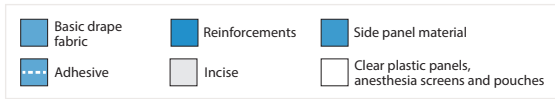

### Craniotomy Drape

Sterile No.	Nonsterile No.	Qty. Cs
9450	9450N	7

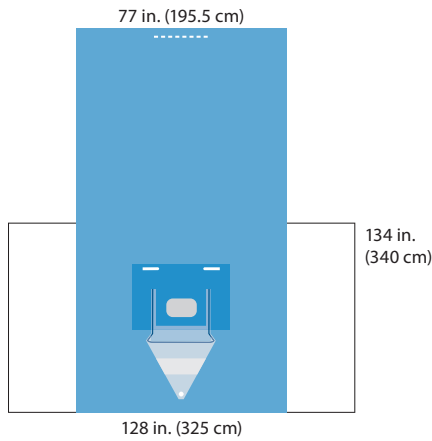

- Absorbent reinforcement, 35 x 22 in. (89 x 56 cm)
- Fenestration, oval with full incise, 11 x 7 in. (28 x 18 cm)
- Clear anesthesia panels
- Fluid control drawstring pouch with screen and port, open or closed with cap, 20 x 40 in. (51 x 102 cm)
- Velcro® Cord-Holding Tabs

### Neurological Drape

Sterile No.	Nonsterile No.	Qty. Cs
9448	9448N	8

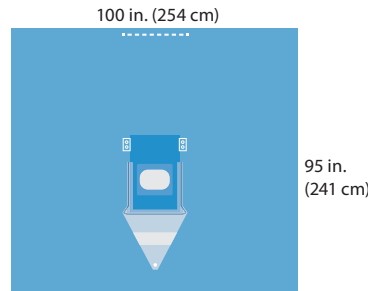

- Absorbent reinforcement, 18.5 x 28.5 in. (47 x 72 cm)
- Fenestration, oval with full incise, 11 x 7 in. (28 x 18 cm)
- Fluid control drawstring pouch with screen and port, open or closed with cap, 20 x 40 in. (51 x 102 cm)
- Cord-holding tabs

### Neurological Drape

Sterile No.	Nonsterile No.	Qty. Cs
9449	9449N	8

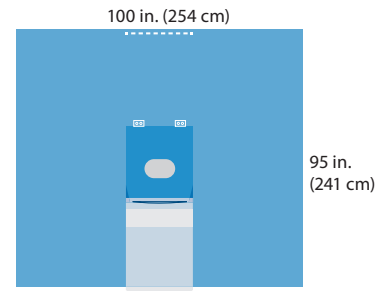

- Absorbent reinforcement, 35 x 28 in. (89 x 71 cm)
- Fenestration, oval with full incise, 11 x 7 in. (28 x 18 cm)
- X-Large fluid control drawstring pouch with screen and closed port, 24 x 42 in. (61 x 107 cm)
- Cord-holding tabs

### Universal Spine Drape

Sterile No.	Nonsterile No.	Qty. Cs
29418	29418N	7

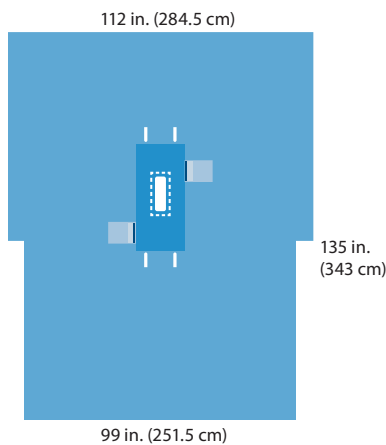

- Absorbent reinforcement, 20 x 37 in. (51 x 94 cm)
- Fenestration, 4 x 12 in. (10 x 30.5 cm)
- Armboard covers
- Instrument pouches, 7.5 x 12 in. (19 x 30.5 cm)
- Velcro® Cord-Holding Tabs

### Craniotomy Split Drape

Sterile No.	Nonsterile No.	Qty. Cs
9439	9439N	8

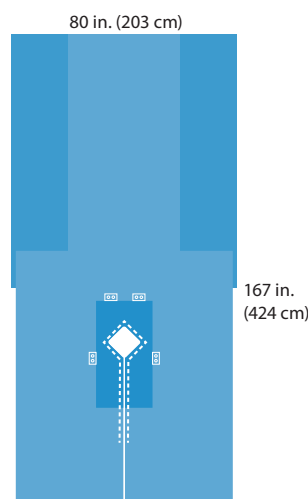

- Absorbent reinforcement, 20 x 38 in. (51 x 96.5 cm)
- Fenestration, diamond, 8 x 8 in. (20 x 20 cm)
- Split, 54 in. (137 cm)
- Attached overhead table cover, 80 x 90 in. (203 x 228.5 cm)
- Cord-holding tabs



**Surgical Drapes and Packs**

# Obstetrics

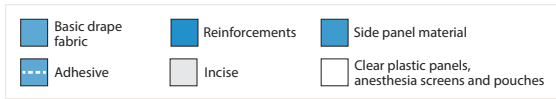

**Cesarean Birth Drape**

Sterile No.	Nonsterile No.	Qty. Cs
29449	29449NB	7

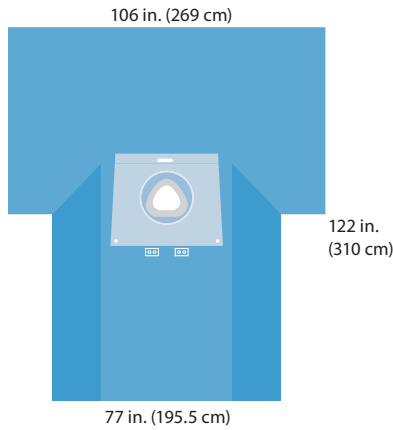

- Fenestration, pear-shaped with 2 in. (5 cm) incise, 12 x 14 in. (30.5 x 35.5 cm)
- Reinforcement below pouch, 17 x 22 in. (43 x 56 cm)
- Armboard covers
- 360-degree fluid control pouch 32 x 30 in. (81 x 76 cm) with contoured foam ring, Velcro® Cord-Holding Tab and Closed Ports
- Cord-holding tabs

**Cesarean Birth Drape**

Sterile No.	Nonsterile No.	Qty. Cs
29443	29443N	7

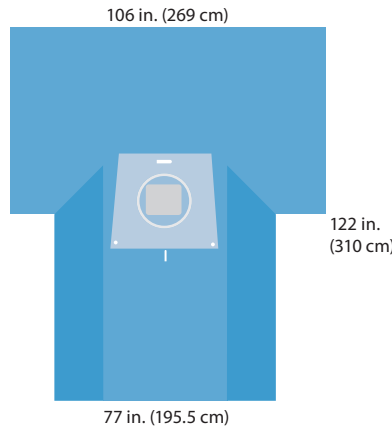

- Fenestration, full incise, 9 x 14 in. (23 x 35.5 cm)
- Reinforcement below pouch, 17 x 22 in. (43 x 56 cm)
- Armboard covers
- 360-degree fluid control pouch, 32 x 30 in. (81 x 76 cm) with contoured foam ring, Velcro® Cord-Holding Tab and Closed Ports
- Velcro® Cord-Holding Tabs

**Cesarean Birth Drape**

Sterile No.	Nonsterile No.	Qty. Cs
29448	29448NB	7

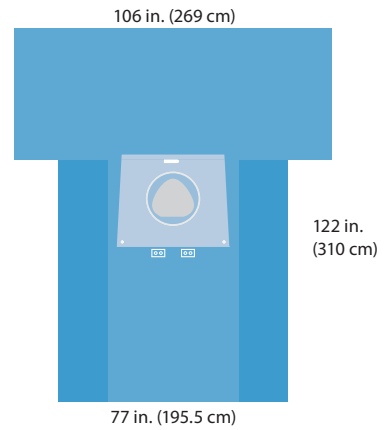

- Fenestration, pear-shaped with full incise, 12 x 14 in. (30.5 x 35.5 cm)
- Reinforcement below pouch, 17 x 22 in. (43 x 56 cm)
- Armboard covers
- 360-degree fluid control pouch, 32 x 30 in. (81 x 76 cm) with contoured foam ring, Velcro® Cord-Holding Tab and Closed Ports
- Cord-holding tabs

**Cesarean Birth Drape**

Sterile No.	Nonsterile No.	Qty. Cs
29452	29452NC	8

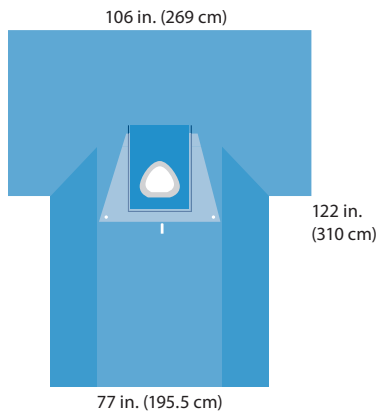

- Fenestration, pear-shaped with 2 in. (5 cm) incise, 12 x 14 in. (30.5 x 35.5 cm)
- Reinforcement around fenestration, 20.375 x 27 in. (51.8 x 68.6 cm) and below pouch, 17 x 22 in. (43 x 56 cm)
- Armboard covers
- 270-degree fluid control pouch with malleable wire, trapezoid shape, 25 x 30 x 45 in. (64 x 76 x 114 cm)
- Velcro® Cord-Holding Tabs

**Cesarean Birth Drape**

Sterile No.	Nonsterile No.	Qty. Cs
29447	29447NB	8

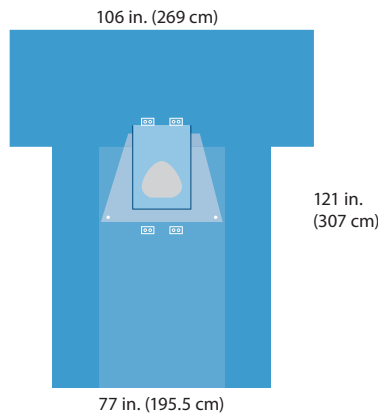

- Fenestration, pear-shaped with full incise, 12 x 14 in. (30.5 x 35.5 cm)
- Reinforcement around fenestration, 20.375 x 27 in. (51.8 x 68.6 cm) and below pouch, 17 x 22 in. (43 x 56 cm)
- Armboard covers
- 270-degree fluid control pouch with malleable wire and closed ports, trapezoid shape, 25 x 30 x 45 in. (64 x 76 x 114 cm)
- Cord-holding tabs

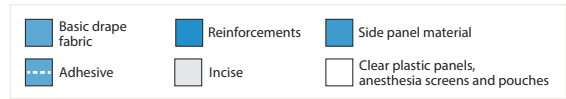

### Cesarean Birth Drape with Dual Layer Anesthesia Screen

Sterile No.	Nonsterile No.	Qty. Cs
29442	29442NA	7

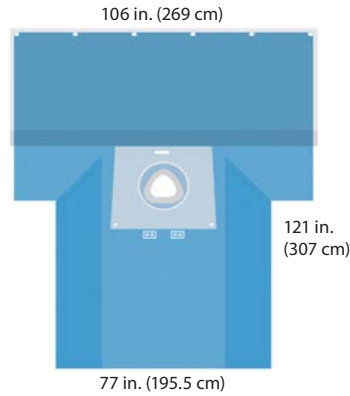

- Fenestration, pear-shaped with 2 in. (5 cm) incise, 12 x 14 in. (30.5 x 35.5 cm)
- Reinforcement below pouch, 17 x 22 in. (43 x 56 cm)
- Armboard covers
- Dual layer anesthesia screen with clear film layer for patient visibility
- 360-degree fluid control pouch, 32 x 30 in. (81 x 76 cm) with contoured foam ring, Velcro® Cord-Holding Tab and Closed Ports
- Cord-holding tabs

### Cesarean Birth Drape

Sterile No.	Nonsterile No.	Qty. Cs
N/A	29453NB	N/A

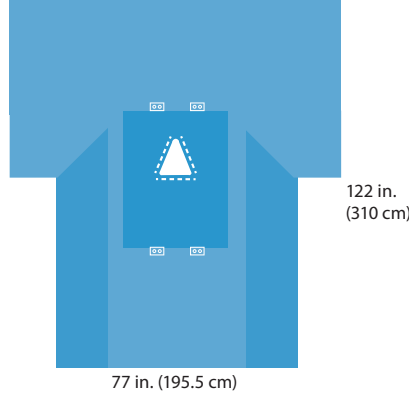

- Fenestration, triangular with adhesive, 12 x 10.5 in. (30.5 x 27 cm)
- Reinforcement, 30.5 x 37 in. (77.5 x 94 cm)
- Armboard covers
- Cord-holding tabs

### Abdominal Cover

Sterile No.	Nonsterile No.	Qty. Cs
N/A	29357NB	N/A



- Absorbent reinforcement, 19 x 19 in. (48 x 48 cm)
- Included in pack 29920

### Obstetrical Pack

Nonsterile No.	Description	29920 Obstetrical Pack
29357NB	Abdominal cover	1
8421NB	Pair of leggings, X-Large	1
8483N	Under-buttocks drape, reinforced poly	1
9355NB	Fan fold drape, 40 x 71 in. (102 x 180 cm)	1
8520N	Absorbent towel	2
8145N	Outer wrap/reinforced poly table cover 44 x 75 in. (111.7 x 190.5 cm), reinforcement 24 x 75 in. (61 x 190.5 cm)	1
<b>Quantity per case</b>		<b>6</b>



Ophthalmology and EENT

Surgical Drapes and Packs

# Ophthalmology and EENT

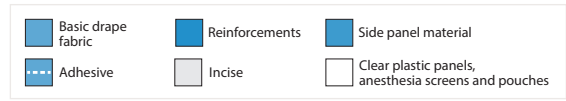

### Small Drape with Adhesive Aperture

Sterile No.	Nonsterile No.	Qty. Cs
8441	8441N	40

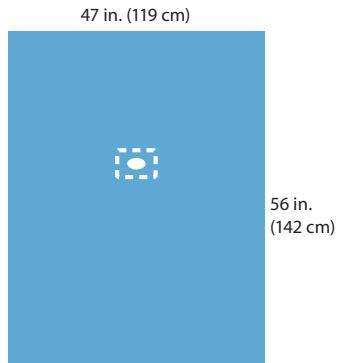

- Oval fenestration 2 x 3 in. (5 x 7.5 cm)

### Ophthalmic Incise Drape

Sterile No.	Nonsterile No.	Qty. Cs
D2019	D2019NS	30

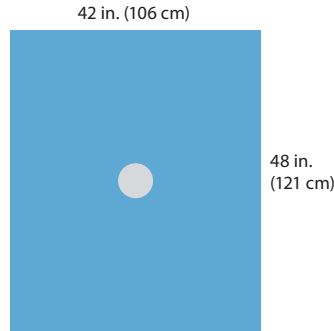

- Incise Area, 3 in. dia. (7 cm dia.)

### Ophthalmic Drape

Sterile No.	Nonsterile No.	Qty. Cs
7444	7444N	10

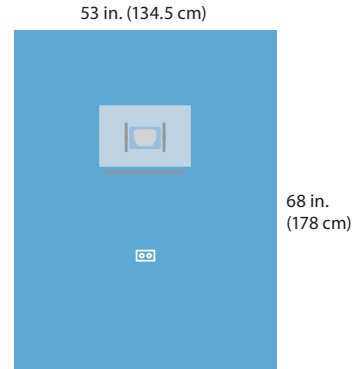

- Dual saddlebag fluid control pouches with malleable strips
- Malleable breather-bar
- Cord-holding tab
- Full incise, 4 x 5 in. (10 x 13 cm)

### Ophthalmic Drape

Sterile No.	Nonsterile No.	Qty. Cs
7445	7445N	10

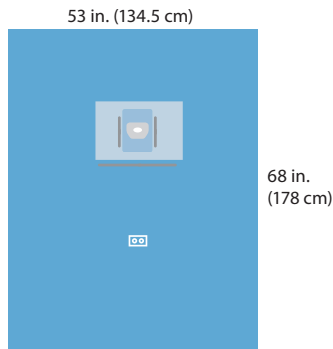

- Dual saddlebag fluid control pouches with malleable strips, 11 1/8 x 19 in. (28 x 48 cm)
- Malleable breather-bar
- Cord-holding tab
- Oval incise aperture, 1.5 x 2.5 in. (4 x 6 cm)

### Ophthalmic Incise Drape

Sterile No.	Nonsterile No.	Qty. Cs
D1062	D1062NS	10

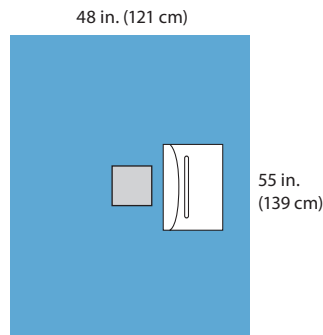

- Incise Area, 4 x 4 in. (10 x 10 cm)
- Pouch, 11 x 12 in. (28 x 30 cm)

### Ophthalmic Drape with Pouch

Sterile No.	Nonsterile No.	Qty. Cs
9562	9562N	10

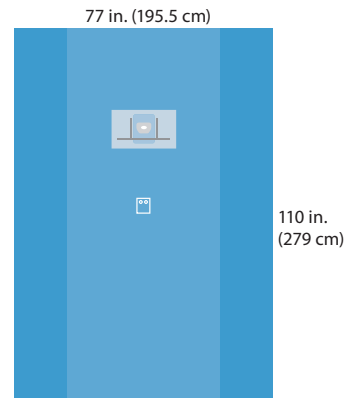

- Attached fluid control saddlebag pouch, 11 1/8 x 19 in. (28 x 48 cm)
- Malleable breathing bar
- Cord-holding tab
- Oval aperture with incise, 1.5 x 2.5 in. (4 x 6 cm)
- Separate incise sheet, 5 x 4 in. (13 x 10 cm)

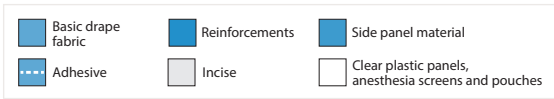

### Eye Drape with Pouch

Sterile No.	Nonsterile No.	Qty. Cs
9565	9565N	10

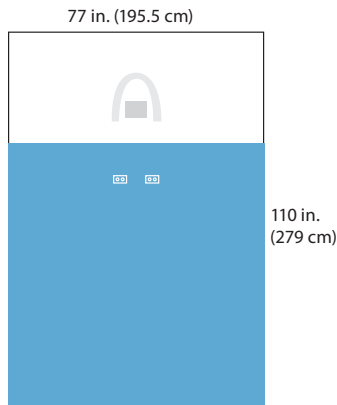

- Attached fluid control pouch, 77 x 35 in. (196 x 89 cm), with closed port specifically designed for use with a wrist rest
- Clear view top panel, 77 x 35 in. (195.5 x 89 cm)
- Cord-holding tabs
- Full incise, 5 x 4 in. (13 x 10 cm)

### EENT Split Drape

Sterile No.	Nonsterile No.	Qty. Cs
N/A	9442NA	N/A

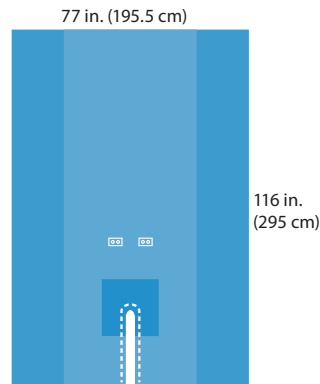

- Absorbent reinforcement, 17 x 20 in. (43 x 51 cm)
- Split with adhesive, 25 x 2.5 in. (63.5 x 6 cm)
- Cord-holding tabs
- Included in pack 9194

### Large EENT Split Drape

Sterile No.	Nonsterile No.	Qty. Cs
9447	9447NA	8

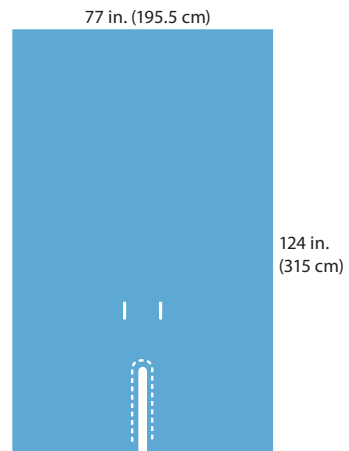

- Split with adhesive, 2.5 x 25 in. (6 x 63.5 cm)
- Velcro® Cord-Holding Tabs
- Included in pack 9196

### Large EENT Split Drape

Sterile No.	Nonsterile No.	Qty. Cs
TB9441	9441N	8

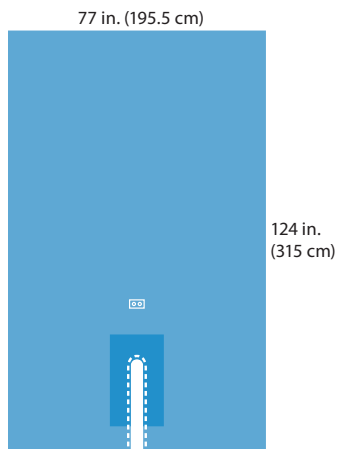

- Absorbent reinforcement, 15.25 x 28 in. (39 x 71 cm)
- Split with adhesive, 3.5 x 28 in. (9 x 71 cm)
- Cord-holding tabs

### Head/Bar Drape

Sterile No.	Nonsterile No.	Qty. Cs
9556	9556N	20

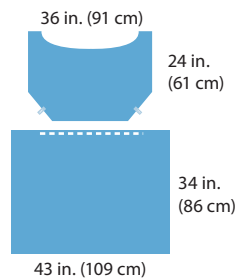

- Cord-holding tabs
- Turban
- Included in pack 9194, 9196

### Bar Drape

Sterile No.	Nonsterile No.	Qty. Cs
N/A	9557N	N/A

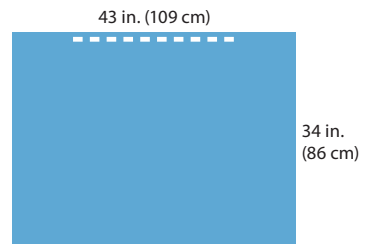

- Adhesive

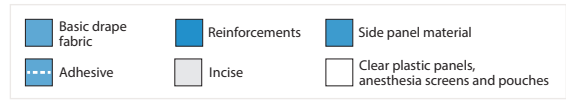

### Ophthalmic Incise Drape

Sterile No.	Nonsterile No.	Qty. Cs
D1021	D1021NS	10

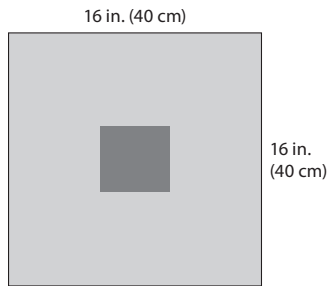

- Incise Area, 5 x 4.25 in. (12 x 11 cm)

### Aperture Drape

Sterile No.	Nonsterile No.	Qty. Cs
D1020	D1020NS	10

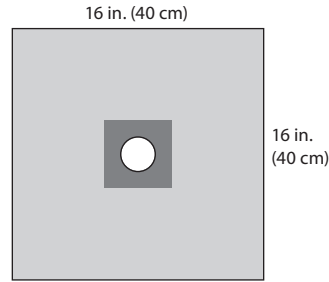

- Aperture, 2.5 in. dia. (6 cm dia.)

### Ophthalmic Incise Pouch

Sterile No.	Nonsterile No.	Qty. Cs
D1025	D1025NS	10

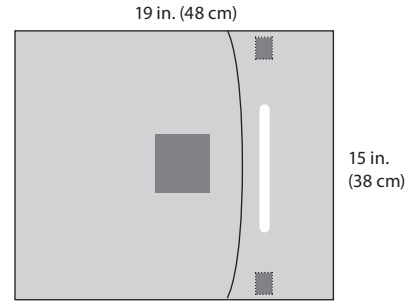

- Incise Area, 5 x 4.25 in. (12 x 11 cm)
- Adhesive Tabs, (2) 1 x 2 in. (2.5 x 5 cm)

### Strabismus Drape

Sterile No.	Nonsterile No.	Qty. Cs
D2043	D2043NS	10

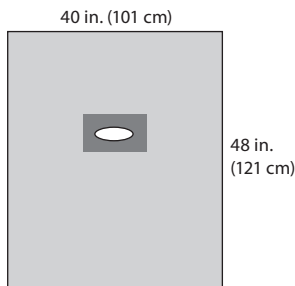

- Aperture, 5.2 x 1.5 in. (13 x 4 cm)

### Ophthalmic Incise Drape

Sterile No.	Nonsterile No.	Qty. Cs
D1060	D1060NS	10

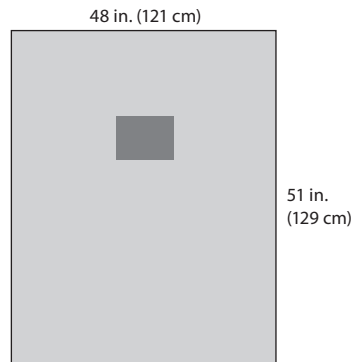

- Incise Area, 5 x 4.25 in. (12 x 11 cm)

### Aperture Drape

Sterile No.	Nonsterile No.	Qty. Cs
D1030	D1030NS	10

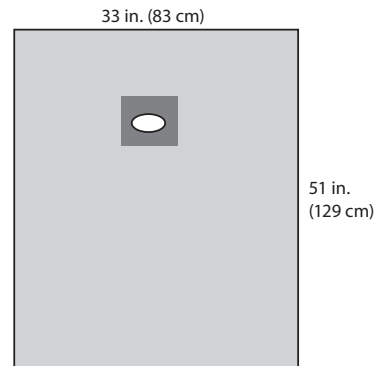

- Aperture, 3 x 2 in. (7 x 5 cm)



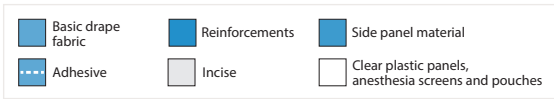

### Ophthalmic Incise Drape

Sterile No.	Nonsterile No.	Qty. Cs
D1061	D1061NS	10

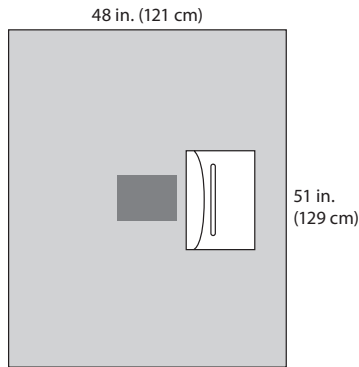

- Incise Area, 5 x 4.25 in. (12 x 11 cm)
- Pouch, 11 x 12 in. (28 x 30 cm)

### Ophthalmic Aperture Drape

Sterile No.	Nonsterile No.	Qty. Cs
D1031	D1031NS	10

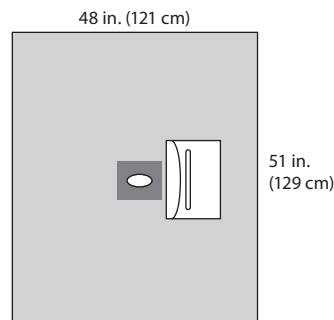

- Aperture, 3 x 2 in. (7 x 5 cm)
- Pouch, 11 x 12 in. (28 x 30 cm)

### Ophthalmic Incise Drape

Sterile No.	Nonsterile No.	Qty. Cs
D2258	N/A	10

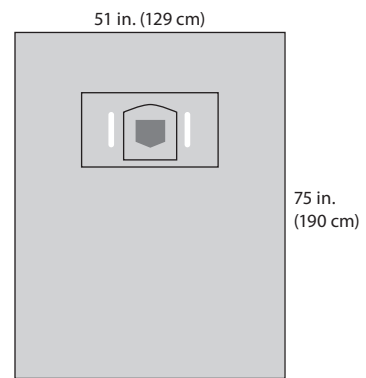

- Incise Area, 4.5 x 5 in. (11 x 12 cm)
- Pouch, 21 x 11.5 in. (53 x 29 cm)

### Head and Neck Packs

Nonsterile No.	Description	9194 Head and Neck Pack	9196 Head and Neck Pack
9556N	Head/Bar Drape, adhesive	1	1
9442NA	Split Drape, reinforced, adhesive	1	
9447NA	Large EENT split drape		1
90270NB	AAMI 3 NonReinforced Scrub Nurse Gown, Large, with towel and wrap	1	1
9515NB	AAMI 3 NonReinforced Surgical Gown, Large	1	1
8554NA	Drape towel, adhesive, nonabsorbent	2	2
8520N	Absorbent towel	1	1
8337N	Mayo stand cover, reinforced poly, 23 in. wide (58 cm)	1	1
8694-61	Suture bag	1	1
8146N	Outer wrap, reinforced poly table cover, 44 x 90 in. (111.7 x 228.6 cm)	1	1
<b>Quantity per case</b>		<b>6</b>	<b>6</b>



Orthopedics

Surgical Drapes and Packs

# Orthopedics

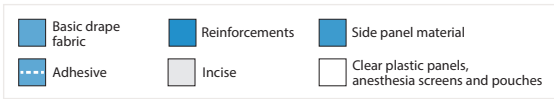

### HD Extremity Drape

Sterile No.	Nonsterile No.	Qty. Cs
59405	59405NA	6

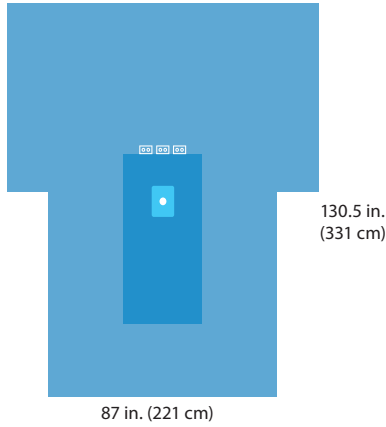

- Heavyweight, premium fabric
- Absorbent reinforcement, 30.5 x 55.5 in. (77.5 x 141 cm)
- Fenestration, circular elastic, 2.5 in. (6 cm)
- Anesthesia screen
- Armboard covers
- Cord-holding tabs
- Included in pack 59180

### HD Arthroscopy Drape

Sterile No.	Nonsterile No.	Qty. Cs
59413	59413N	6

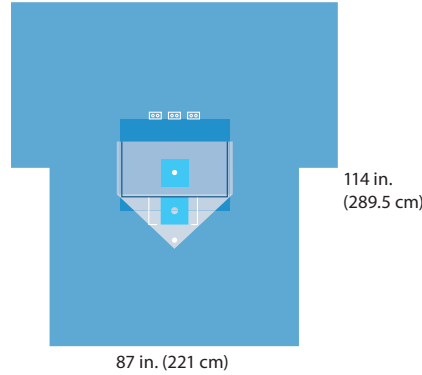

- Heavyweight, premium fabric
- Absorbent reinforcement
- Dual fenestration, circular elastic, 2 in. (6 cm)
- Anesthesia screen
- Armboard covers
- Cord-holding tabs
- Fluid control pouch with malleable wire drawstring pouch and closed port, 40 x 34½ in. (102 x 88 cm)
- Included in pack 9197

### HD Hip Drape with Pouches

Sterile No.	Nonsterile No.	Qty. Cs
59439	59439N	4

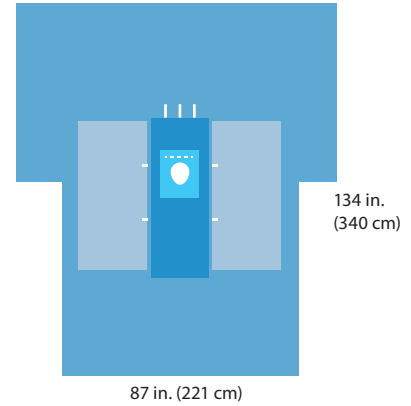

- Heavyweight, premium fabric
- Absorbent reinforcement, 21 x 57 in. (53 x 145 cm)
- Fenestration, pear-shaped elastic, 6.75 x 8.25 in. (17 x 21 cm)
- Anesthesia screen
- Armboard covers
- Velcro® Cord-Holding Tabs
- Clear leg positioning pouches, 54 x 30 in. (137 x 76 cm)

### HD Split Drape

Sterile No.	Nonsterile No.	Qty. Cs
59438	59438N	10

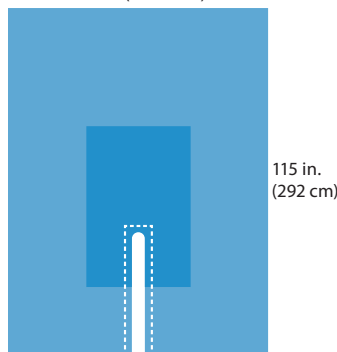

- Heavyweight, premium fabric
- Absorbent reinforcement, 33.5 x 53 in. (79 x 134.5 cm)
- Split with adhesive, 4 x 40 in. (10 x 101.5 cm)

### HD Top Drape

Sterile No.	Nonsterile No.	Qty. Cs
59352	59352NA	10

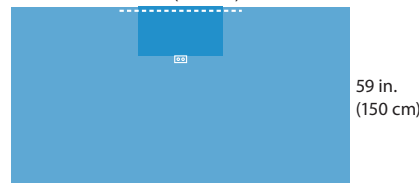

- Heavyweight, premium fabric
- Absorbent reinforcement, 31 x 16.75 in. (79 x 42.5 cm)
- Cord-holding tab





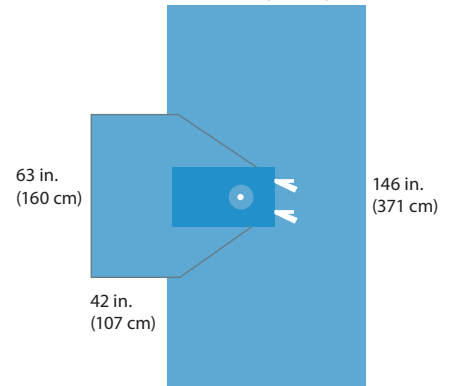

### HD Hand Drape

Sterile No.	Nonsterile No.	Qty. Cs
59427	59427N	18



- Heavyweight, premium fabric
- Absorbent reinforcement, 16.75 x 35 in. (42.5 x 89 cm)
- Fenestration, circular elastic, 2 in. (5 cm)
- Hand table extension
- Velcro® Cord-Holding Tabs

# Orthopedics — Heavy Duty

 Basic drape fabric	 Reinforcements	 Side panel material
 Adhesive	 Incise	 Clear plastic panels, anesthesia screens and pouches

## HD Dual Split Shoulder Drape

Sterile No.	Nonsterile No.	Qty. Cs
59274	59274N	10

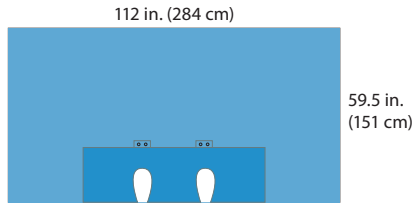

- Heavyweight, premium fabric
- Absorbent reinforcement, 20.5 x 48 in. (52 x 122 cm)
- Dual 6 x 8 in. (15 x 20 cm) split fenestrations with adhesive

## HD Shoulder Drape with Pouch

Sterile No.	Nonsterile No.	Qty. Cs
59362	59362N	10

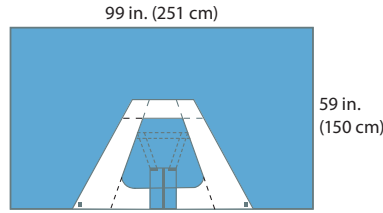

- Heavyweight, premium fabric
- Fenestration, pear-shaped split with adhesive
- Fluid control pouch with malleable wire and two suction closed ports, trapezoid shape 58½ x 36 x 20 in. (149 x 91 x 51 cm)
- Included in pack 59368

## HD Split Drape

Sterile No.	Nonsterile No.	Qty. Cs
59363	59363N	10

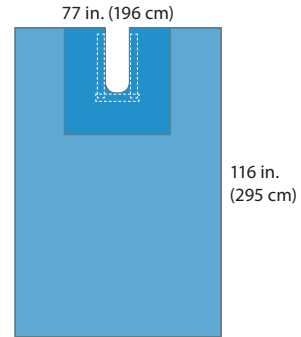

- Heavyweight, premium fabric
- Reinforcement, 40 x 40 in. (101.5 x 101.5 cm)
- Split with adhesive, 10 x 25 in. (25.5 x 63.5 cm)
- Included in pack 59368

## HD Packs

Nonsterile No.	Description	59180 HD Lower Extremity Pack	9197 HD Arthroscopy Pack	59368 HD Arthroscopy Pack
59405NA	HD Extremity Drape	1		
59413N	HD Arthroscopy Drape		1	
59362N	HD Shoulder Drape with Pouch			1
59363N	HD Split Drape			1
90270NB	AAMI 3 NonReinforced Scrub Nurse Gown, Large, with towel and wrap	1	1	
32474NA	AAMI 4 Breathable Surgical Gown, X-Large, X-Long, Specialty	1	1	
8520N	Absorbent towel	1	1	
8474N	Prep U-drape, 60 x 60 in. (152 x 152 cm), 6 x 21 in. (15 x 53 cm), split	1	1	
8476NA	Prep U-drape, 60 x 72 in. (152 x 183 cm), 6 x 21 in. (15 x 53 cm), split	1	1	
8694-61	Suture bag	1	1	
8337N	Mayo stand cover, reinforced poly, 23 in. (58 cm) wide	1	1	
1582NB	Stockinette, 12 x 48 in. (30.5 x 122 cm), X-Large	1	1	
FG71-2384C	Tubing, 12 ft. x 6 mm	1	1	
3524N	Drape tape	3	3	
8186NA	Outer wrap, reinforced poly table cover, 60 x 90 in. (152 x 228.6 cm), heavy-duty	1	1	
	<b>Quantity per case</b>	<b>6</b>	<b>6</b>	

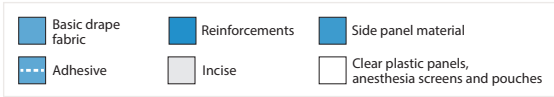

**Split Drape**

Sterile No.	Nonsterile No.	Qty. Cs
29431	29431N	10

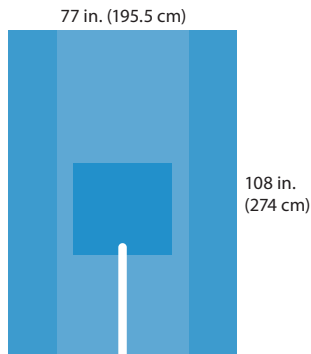

- Absorbent reinforcement, 30.5 x 42 in. (77.5 x 107 cm)
- Split without adhesive, 2.5 x 37 in. (6 x 94 cm)

**Split Drape**

Sterile No.	Nonsterile No.	Qty. Cs
29434	29434N	20

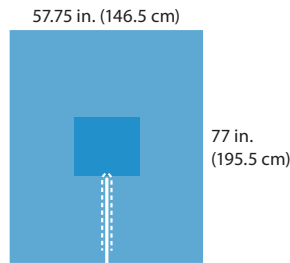

- Absorbent reinforcement, 20 x 18.5 in. (51 x 47 cm)
- Split with adhesive, 1 x 28.25 in. (2.5 x 72 cm)

**Split Drape**

Sterile No.	Nonsterile No.	Qty. Cs
29436	29436NC	10

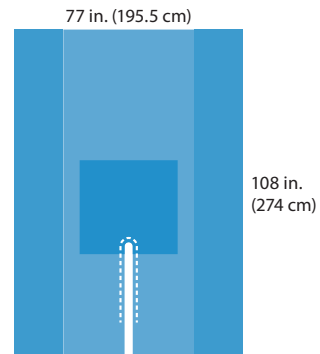

- Absorbent reinforcement, 30.5 x 42 in. (77.5 x 107 cm)
- Split with adhesive, 2.5 x 37 in. (6 x 94 cm)
- Included in packs 29182

**Split Drape**

Sterile No.	Nonsterile No.	Qty. Cs
29440	29440NC	10

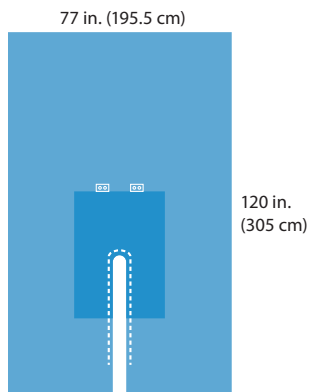

- Absorbent reinforcement, 30.5 x 42 in. (77.5 x 107 cm)
- Split with adhesive, 6 x 46 in. (15 x 117 cm)
- Cord-holding tabs

**Orthopedic Split Drape**

Sterile No.	Nonsterile No.	Qty. Cs
29476	29476N	10

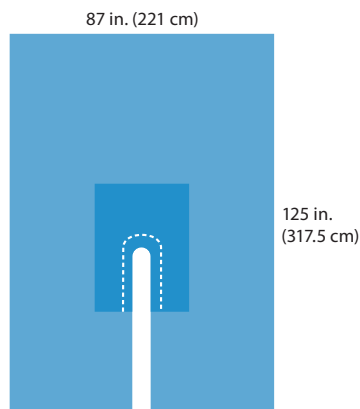

- Absorbent reinforcement, 30.5 x 42 in. (77.5 x 107 cm)
- Split with adhesive, 6 x 54 in. (15 x 137 cm)

**Split Sheet Drape**

Sterile No.	Nonsterile No.	Qty. Cs
29445	29445NB	8

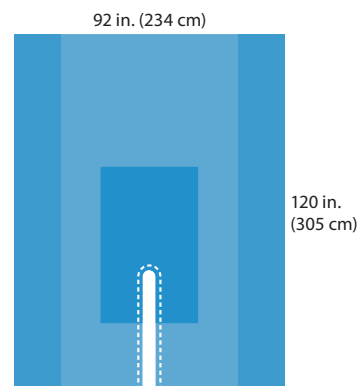

- Absorbent reinforcement, 30.5 x 42 in. (77.5 x 107 cm)
- Split with adhesive, 4 x 40 in. (10 x 101 cm)

# Surgical Drapes and Packs

## Orthopedics

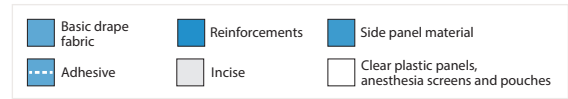

### Split Drape

Sterile No.	Nonsterile No.	Qty. Cs
N/A	9361NB	N/A

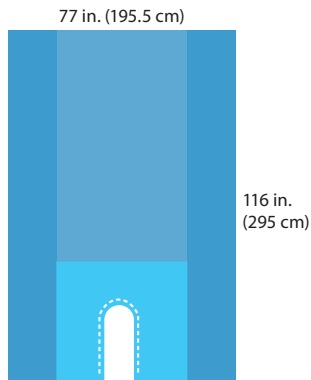

- Reinforcement, 44 x 40 in. (112 x 101.5 cm)
- Split with adhesive, 10 x 25 in. (25.5 x 63.5 cm)
- Included in packs 9183, 29367, 29365, 29160

### General Ortho Packs

Nonsterile No.	Description	29181 General Orthopedic Pack	29182 Orthopedic Pack
29440NC	Split Drape with absorbent reinforcement, adhesive	1	
29351NC	Top Drape with absorbent reinforcement, adhesive	1	
9349NB	Fan-Folded Drape Sheet, 52 x 76 in. (132 x 193 cm)		1
29436NC	Split drape, adhesive		1
9040NB	AAMI 4 Poly Reinforced Surgical Gown, X-Large	2	
8520N	Absorbent towel	2	
8694-61	Suture bag	1	1
8337N	Mayo stand cover, reinforced poly, 23 in. (58 cm) wide	1	1
8475NA	U-Drape, poly, adhesive, 60 x 84 in. (152 x 213 cm), 8 x 30 in. (20 x 76 cm) split	1	
8476NA	U-Drape, poly, adhesive, 60 x 72 in. (152 x 183 cm), 6 x 21 in. (15 x 53 cm) split		1
1582NB	Stockinette, 12 x 48 in. (30.5 x 122 cm), X-Large	1	
8554NA	Drape towel, adhesive, nonabsorbent	4	4
8143N	Outer wrap, reinforced poly table cover, 50 x 90 in. (127 x 228.6 cm)	1	1
<b>Quantity per case</b>		<b>4</b>	<b>5</b>

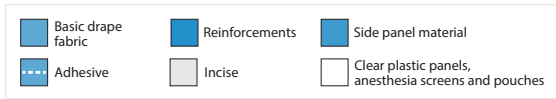

### Arthroscopy Drape for Dropped Leg Procedures

Sterile No.	Nonsterile No.	Qty. Cs
9414	9414NB	12

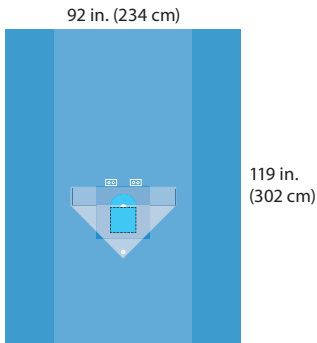

- Absorbent reinforcement, 20 x 20 in. (51 x 51 cm)
- Dual fenestration, circular elastic, 2.5 in. (6 cm)
- Fluid control pouch with malleable wire and closed port, 38 x 27 in. (97 x 69 cm)
- Cord-holding tabs
- Included in pack 9185

### Arthroscopy Drape with Armboard Covers

Sterile No.	Nonsterile No.	Qty. Cs
9423	9423NA	12

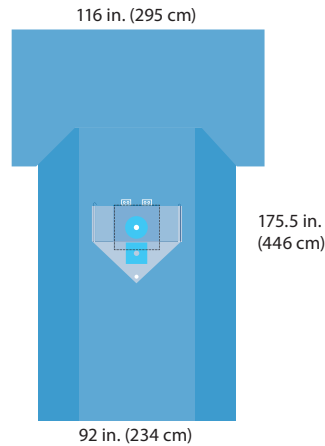

- Reinforcement, 20 x 20 in. (51 x 51 cm)
- Dual fenestration, circular elastic, 2.5 in. (6 cm)
- Anesthesia screen
- Armboard covers
- Fluid control pouch with malleable wire and closed port, 40 x 34½ in. (102 x 88 cm)
- Cord-holding tabs

### Hand Drape

Sterile No.	Nonsterile No.	Qty. Cs
29427	29427NC	18

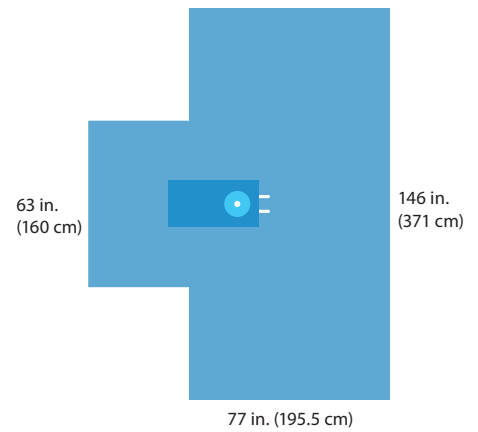

- Absorbent reinforcement, 16.75 x 34 in. (42.5 x 89 cm)
- Fenestration, circular elastic, 2 in. (5 cm)
- Hand table extension
- Velcro® Cord-Holding Tabs

### Hip Drape

Sterile No.	Nonsterile No.	Qty. Cs
29430	29430NB	12

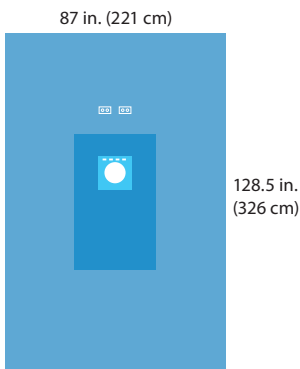

- Absorbent reinforcement, 30.5 x 50 in. (77.5 x 127 cm)
- Fenestration, circular elastic, 8 in. (20 cm)
- Cord-holding tabs
- Included in pack 29187

### Hip Drape with Pouches

Sterile No.	Nonsterile No.	Qty. Cs
29439	29439NB	5

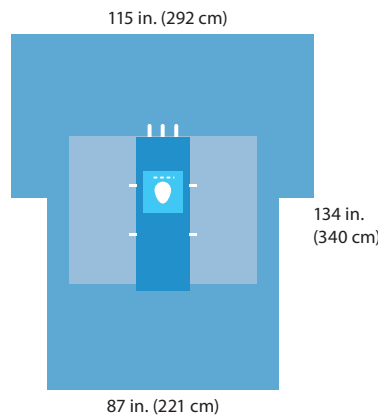

- Absorbent reinforcement, 21.375 x 57 in. (54 x 145 cm)
- Fenestration, pear-shaped elastic, 6.75 x 8.25 in. (17 x 21 cm)
- Anesthesia screen
- Armboard covers
- Velcro® Cord-Holding Tabs
- Clear leg positioning pouches, 54.5 x 30 in. (138 x 76 cm)

### Hip Drape



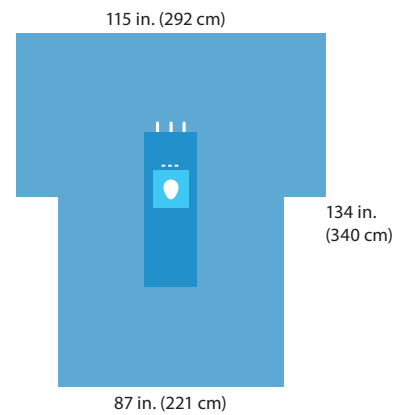



Sterile No.	Nonsterile No.	Qty. Cs
29444	29444N	5



- Absorbent reinforcement, 21.375 x 57 in. (54 x 145 cm)
- Fenestration, pear-shaped elastic, 6.75 x 8.25 in. (17 x 21 cm)
- Anesthesia screen
- Armboard covers
- Velcro® Cord-Holding Tabs

# Surgical Drapes and Packs

## Orthopedics

 Basic drape fabric	 Reinforcements	 Side panel material
 Adhesive	 Incise	 Clear plastic panels, anesthesia screens and pouches

### Arthroscopy Hand and Hip Packs

Nonsterile No.	Description	9419 Hand Pack	29187 Hip Pack	9185 Arthroscopy Pack II for Dropped Leg Procedures
29427NC	Hand Drape	1		
29430NB	Hip Drape		1	
9414NB	Arthroscopy Drape with pouch for dropped leg procedures			1
9040NB	AAMI 4 Poly Reinforced Surgical Gown, X-Large		2	
32474NA	AAMI 4 Breathable Surgical Gown, X-Large, X-Long, Specialty			1
90270NB	AAMI 3 NonReinforced Scrub Nurse Gown, Large, with towel and wrap			1
8520N	Absorbent towel		2	
8694-61	Suture bag	1	1	1
8337N	Mayo Stand Cover, reinforced poly, 23 in. (58 cm) wide	1	1	1
8475NA	U-Drape, poly, adhesive, 60 x 84 in. (152 x 213 cm), 8 x 30 in. (20 x 76.2 cm) split		1	
8476NA	Prep U-drape, 60 x 72 in. (152 x 183cm), 6 x 21 in. (15 x 53 cm) split	1		2
1582NB	Stockinette, 12 x 48 in. (30.5 x 122 cm), X-Large		1	
1586N	Stockinette, 9 x 48 in. (23 x 122 cm), Large			1
3524	Drape tape			4
8554NA	Drape towel, adhesive, nonabsorbent		2	
8143N	Outer wrap, reinforced poly table cover, 50 x 90 in. (127 x 228.6 cm)	1	1	1
	<b>Quantity per case</b>	<b>5</b>	<b>6</b>	<b>6</b>



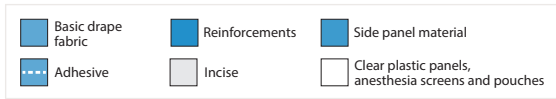

### Extremity Drape

Sterile No.	Nonsterile No.	Qty. Cs
29414	29414NC	12

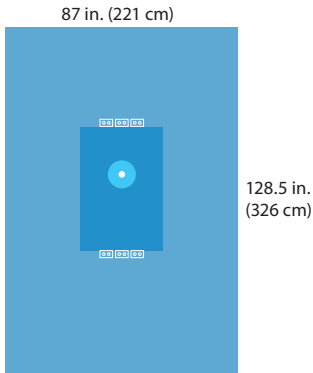

- Absorbent reinforcement, 30.5 x 42 in. (77.5 x 107 cm)
- Fenestration, circular elastic, 2.5 in. (6 cm)
- Cord-holding tabs
- Included in packs 29188, 29189

### Extremity Drape

Sterile No.	Nonsterile No.	Qty. Cs
29405	29405NC	6

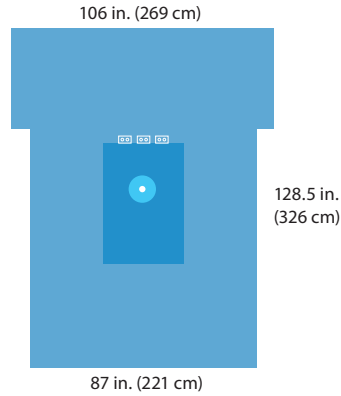

- Absorbent reinforcement, 30.5 x 42 in. (77.5 x 107 cm)
- Fenestration, circular elastic, 2.5 in. (6 cm)
- Anesthesia screen
- Armboard covers
- Cord-holding tabs

### Extremity Drape with Armboard Covers

Sterile No.	Nonsterile No.	Qty. Cs
29435	29435NB	8

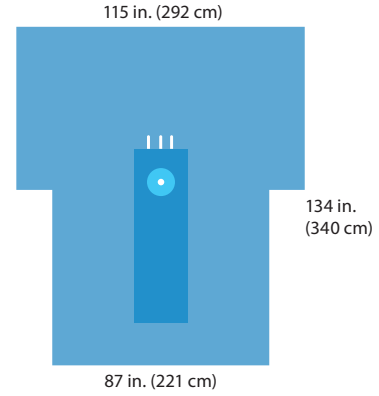

- Absorbent reinforcement, 24 x 66.5 in. (61 x 169 cm)
- Fenestration, circular elastic, 2.5 in. (6 cm)
- Anesthesia screen
- Armboard covers
- Velcro® Cord-Holding Tabs

### Bilateral Limb Drape

Sterile No.	Nonsterile No.	Qty. Cs
29416	29416N	12

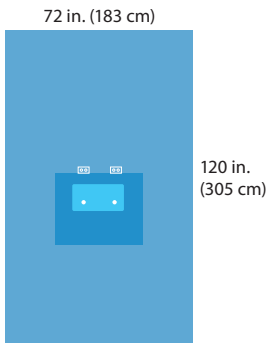

- Absorbent reinforcement, 31 x 27 in. (79 x 68.5 cm)
- Dual fenestration, circular elastic, 1.5 in. (4 cm)
- Cord-holding tabs

### Bilateral Limb Drape



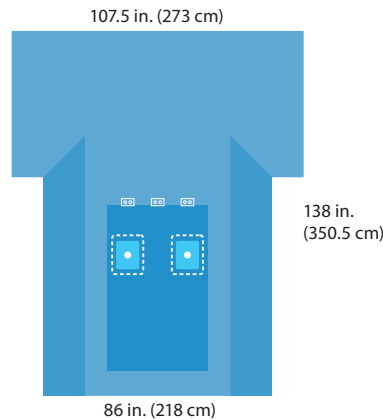



Sterile No.	Nonsterile No.	Qty. Cs
29417	29417N	8



- Absorbent reinforcement, 37.5 x 61 in. (95 x 155 cm)
- Dual fenestration, circular elastic, 2.5 in. (6 cm)
- Anesthesia screen
- Armboard covers
- Cord-holding tabs

# Surgical Drapes and Packs

## Orthopedics

 Basic drape fabric	 Reinforcements	 Side panel material
 Adhesive	 Incise	 Clear plastic panels, anesthesia screens and pouches

### Extremity Packs

Nonsterile No.	Description	29180 Arthroscopy Pack	29186 Arthroscopy Pack	29188 Fluid Control Extremity Pack	29189 Fluid Control Extremity Pack
29414NC	Extremity Drape	1	1	1	1
9040NB	AAMI 4 Poly Reinforced Surgical Gown, X-Large	1			2
32474NA	AAMI 4 Breathable Surgical Gown, X-Large, X-Long, Specialty		1		
90270NB	AAMI 3 NonReinforced Scrub Nurse Gown, Large, with towel and wrap		1		
8520N	Absorbent towel	1			1
8694-61	Suture bag	1	1	1	1
8337N	Mayo stand cover, reinforced poly, 23 in. (58 cm) wide	1	1	1	1
8476NA	Prep U-drape, 60 x 72 in. (152 x 183 cm), 6 x 21 in. (15 x 53 cm) split	1	2		
8375N	Plastic sheet, fan-folded, 44 x 60 in. (112 x 152 cm)			1	1
1582NB	Stockinette, 12 x 48 in. (30.5 x 122 cm), X-Large	1			
1586N	Stockinette, 9 x 48 in. (23 x 122 cm), Large		1		
3524	Drape tape		4		
8554NA	Drape towel, adhesive, nonabsorbent			2	3
8143N	Outer wrap, reinforced poly table cover, 50 x 90 in. (127 x 228.6 cm)	1	1	1	1
<b>Quantity per case</b>		<b>6</b>	<b>6</b>	<b>5</b>	<b>6</b>

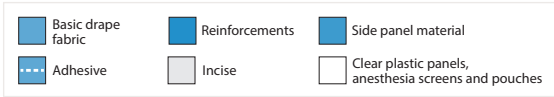

### Beach Chair Shoulder Drape

Sterile No.	Nonsterile No.	Qty. Cs
29369	29369NB	5

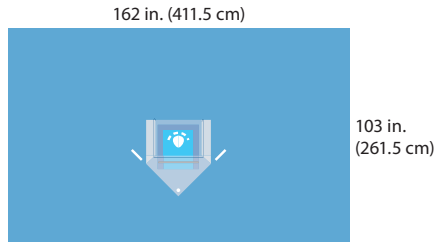

- Fenestration, pear-shaped, 5.5 x 5.75 in. (14 x 14.5 cm)
- Fluid control pouch with malleable wire drawstring pouch and closed port, 30 x 36 in. (76 x 91 cm)
- Velcro® Cord-Holding Tabs

### Beach Chair Shoulder Drape

Sterile No.	Nonsterile No.	Qty. Cs
29063	29063N	5

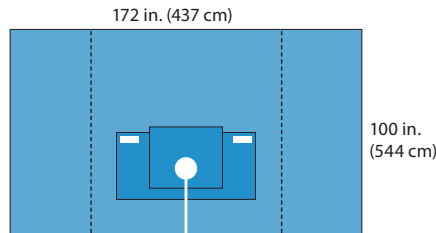

- Circular 10 in. (25 cm) fenestration with 32 in. (81 cm) split
- Velcro® Cord-Holding Tabs
- Pouch attachment zone

### Beach Chair Shoulder Drape with Attachable Pouch

Sterile No.	Nonsterile No.	Qty. Cs
29066	29066N	5

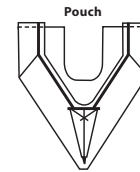
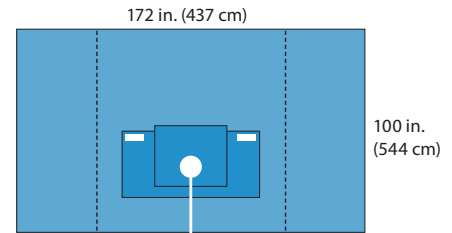

- Circular 10 in. (25 cm) fenestration with 32 in. (81 cm) split
- Velcro® Cord-Holding Tabs
- Pouch attachment zone
- Includes attachable pouch

### Shoulder Drape

Sterile No.	Nonsterile No.	Qty. Cs
N/A	9360NB	N/A

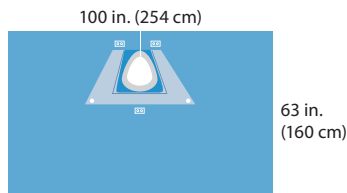

- Fenestration, pear-shaped with split and incise aperture, 11.5 x 14 in. (29 x 35.5 cm)
- Fluid control pouch with drawstring and closed ports, trapezoid shape 45 x 22 x 21 in. (114 x 56 x 53 cm)
- Cord-holding tabs
- Included in packs 9183, 29367

### Split Drape

Sterile No.	Nonsterile No.	Qty. Cs
N/A	9361NB	N/A

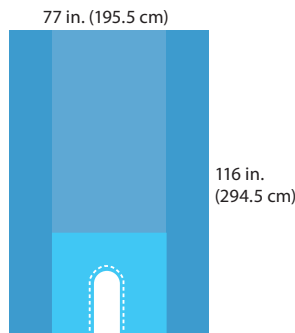

- Reinforcement, 44 x 40 in. (112 x 101.5 cm)
- Split with adhesive, 10 x 25 in. (25 x 63.5 cm)
- Included in packs 9183, 29367, 29365, 29160

### Shoulder Drape

Sterile No.	Nonsterile No.	Qty. Cs
N/A	29365N	N/A

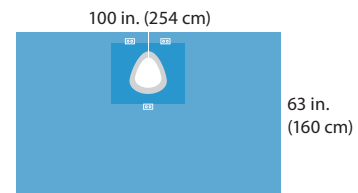

- Absorbent reinforcement, 31 x 22 in. (79 x 56 cm)
- Fenestration, pear-shaped with split and incise aperture, 11.5 x 14 in. (29 x 35.5 cm)
- Cord-holding tabs
- Included in packs 29365, 29160

# Surgical Drapes and Packs

## Orthopedics

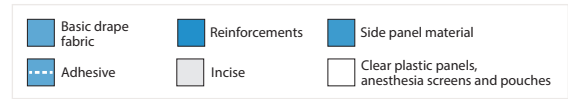

### Top Drape

Sterile No.	Nonsterile No.	Qty. Cs
29352	29351NC	14

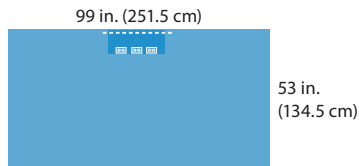

- Absorbent reinforcement, 20 x 9.375 in. (51 x 24 cm)
- Cord-holding tabs
- Included in packs 29181, 29131

### Head Sheet

Sterile No.	Nonsterile No.	Qty. Cs
N/A	29478N	N/A

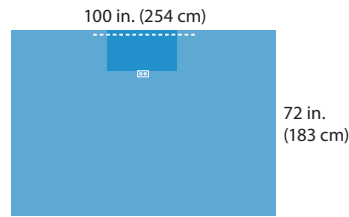

- Absorbent reinforcement, 26 x 15.25 in. (66 x 39 cm)
- Cord-holding tabs

### Shoulder Packs

Nonsterile No.	Description	9183 Fluid Control Shoulder Pack	29367 Fluid Control Shoulder Drape Pack	29365 Shoulder Drape Pack	29160 Shoulder Pack
9360NB	Shoulder Drape with attached fluid control pouch, with incise	1	1		
9361NB	Split Drape, poly reinforced, adhesive	1	1	1	1
29365N	Shoulder Drape with incise, adhesive			1	1
32474NA	AAMI 4 Breathable Surgical Gown, X-Large, X-Long, Specialty	1			1
90270NB	AAMI 3 NonReinforced Scrub Nurse Gown, Large, with towel and wrap	1			1
8520N	Absorbent towel				1
8694-61	Suture bag	1			1
8337N	Mayo Stand Cover, reinforced poly, 23 in. (58 cm) wide	1			1
8476NA	U-Drape, poly, adhesive, 60 x 72 in. (152 x 183 cm), 6 x 21 in. (15 x 53 cm) split				1
8554NA	Drape towel, adhesive, nonabsorbent	4			4
8146N	Outer wrap, reinforced poly table cover, 44 x 90 in. (112 x 228.6 cm)	1			1
<b>Quantity per case</b>		<b>3</b>	<b>10</b>	<b>8</b>	<b>3</b>



**Patient Isolation Drape**

Sterile No.	Nonsterile No.	Qty. Cs
D1014	N/A	5

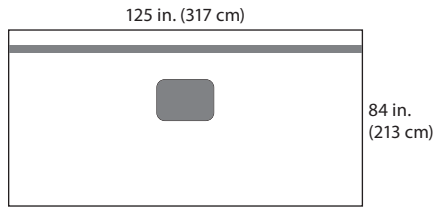

- Adhesive area, 9.5 x 19.5 in. (24 x 50 cm)
- Adhesive strip, 125 x 0.5 in. (317 x 1.3 cm)

**Patient Isolation Drape**

Sterile No.	Nonsterile No.	Qty. Cs
D1017	D1017NS	5

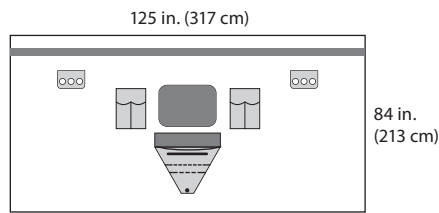

- Adhesive area, 9.5 x 19.5 in. (24 x 50 cm)
- Adhesive strip, 125 x 0.5 in. (317 x 1.3 cm)
- Fluid pouch, 20 x 19 in. (51 x 48 cm)
- Instrument pouches, (2) 6.7 x 11.5 in. (17 x 29 cm)

**Shoulder Pouch**

Sterile No.	Nonsterile No.	Qty. Cs
D1067	D1067NS	5

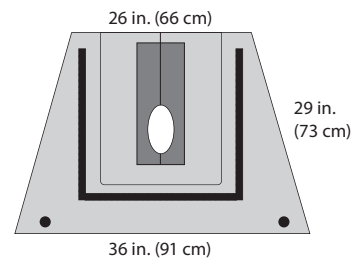

- Adhesive, 9.5 x 19.5 in. (24 x 50 cm)
- Aperture, 7.5 x 10 in. (19 x 25 cm)



## Surgical Drapes and Packs

# Pacemaker

Pacemaker

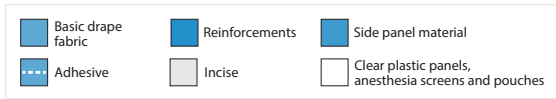

**Pacemaker Drape**

Sterile No.	Nonsterile No.	Qty. Cs
29013	29013N	8

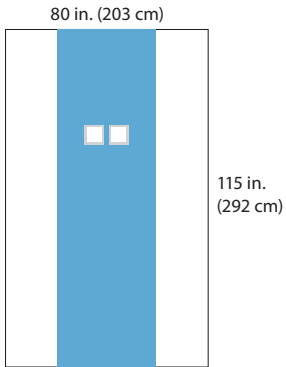

- Absorbent reinforcement, 33.5 x 115 in. (85 x 292 cm)
- Fenestration, dual square, 6 in. (15 cm), with square incise aperture, 4 in. (10 cm)
- Clear side panels

**Pacemaker Drape**

Sterile No.	Nonsterile No.	Qty. Cs
D2310C	D2310NSC	20

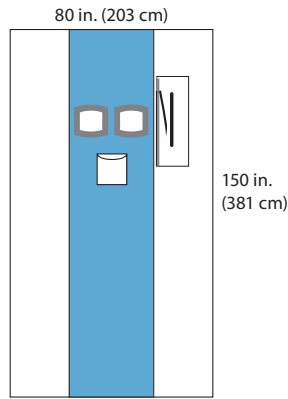

- Absorbent central panel, 29 x 150 in. (74 x 381 cm)
- Apertures, 6 x 4 in. (15 x 10 cm)
- Clear side panels
- Attachable pouches, 11 x 23 in. (27 x 58 cm) 8.5 x 11 in. (21 x 25 cm)

**Pacemaker Sheet**

Sterile No.	Nonsterile No.	Qty. Cs
N/A	C2325NSA*	N/A

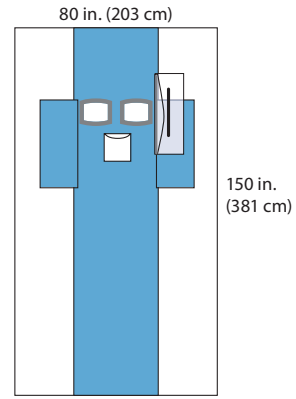

- Absorbent central panel, 29 x 150 in. (74 x 381 cm)
- Additional pads, (2) 15 x 30 in. (38.1 x 76.2 cm)
- Apertures, 8 x 6 in. (20 x 15 cm)
- Clear side panels
- Attachable pouches, 11 x 23 in. (27 x 58 cm) 8.5 x 11 in. (21 x 25 cm)

**Pacemaker Angiography Sheet**

Sterile No.	Nonsterile No.	Qty. Cs
C2362	C2362NS	20

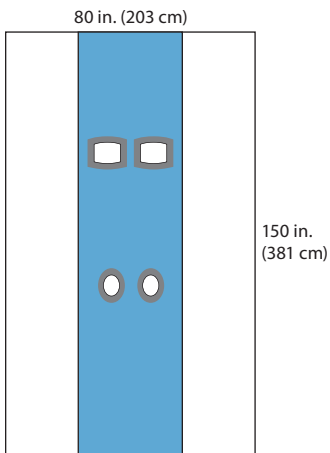

- Absorbent central panel, 29 x 150 in. (74 x 381 cm)
- Rectangular apertures, 6 x 4 in. (15 x 20 cm)
- Oval apertures, 3.5 x 4.5 in. (9 x 11 cm)
- Clear side panels

**Pacemaker Drape**

Sterile No.	Nonsterile No.	Qty. Cs
C2304*	C2304NS*	20

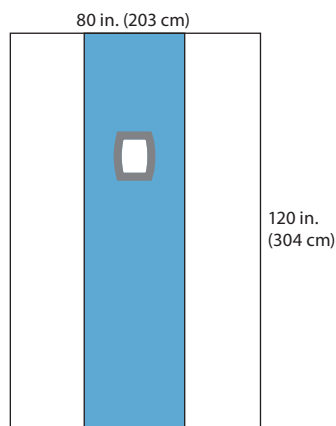

- Absorbent central panel, 29 x 120 in. (74 x 304 cm)
- Aperture, 6 x 8 in. (15 x 20 cm)
- Clear side panels



**Surgical Drapes and Packs**

# Pediatrics



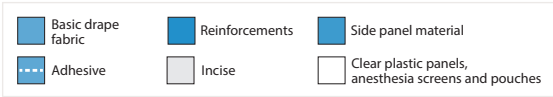

### Pediatric Drape

Sterile No.	Nonsterile No.	Qty. Cs
29492	29492NB	10

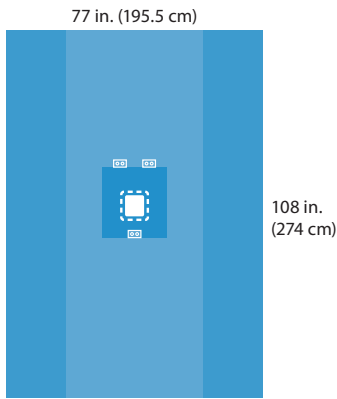

- Absorbent reinforcement, 19 x 20.375 in. (48 x 52 cm)
- Fenestration, 6 x 6 in. (15 x 15 cm)
- Cord-holding tabs

### Minor Procedure Drape

Sterile No.	Nonsterile No.	Qty. Cs
29496	29496NC	10

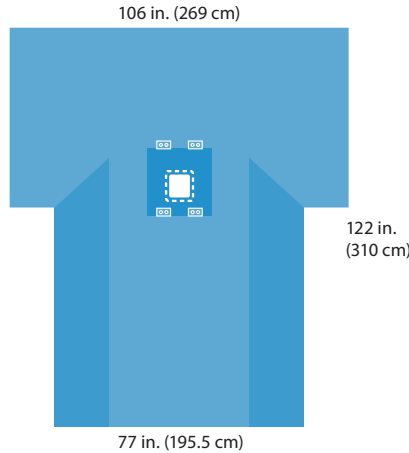

- Absorbent reinforcement, 19 x 19 in. (48 x 48 cm)
- Fenestration, 6 x 6 in. (15 x 15 cm)
- Armboard covers
- Cord-holding tabs

### Neonatal Drape

Sterile No.	Nonsterile No.	Qty. Cs
29494	29494N	20

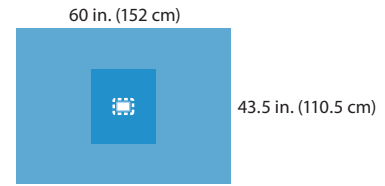

- Absorbent reinforcement, 18 x 20 in. (46 x 51 cm)
- Fenestration, 3 x 4 in. (7.5 x 10 cm)

### Neonatal Drape

Sterile No.	Nonsterile No.	Qty. Cs
9133	N/A	15

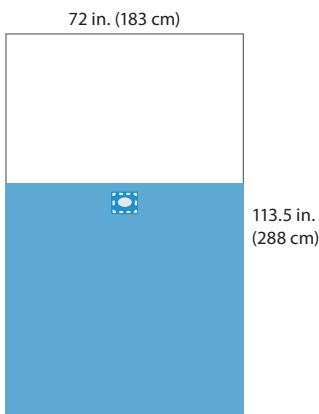

- Film, 10 x 8 in. (25 x 20 cm)
- Clear anesthesia screen
- Drapeable blue poly film base material
- Fenestration, oval, 2 x 4 in. (5 x 10 cm)

### Split Drape

Sterile No.	Nonsterile No.	Qty. Cs
29434	29434N	20

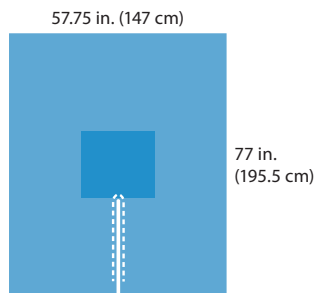

- Absorbent reinforcement, 20.375 x 18.5 in. (52 x 47 cm)
- Split with adhesive, 1 x 28.25 in. (2.5 x 72 cm)

### Circumcision Drape

Sterile No.	Nonsterile No.	Qty. Cs
74210	74210N	160

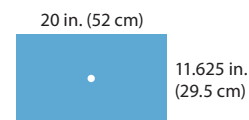





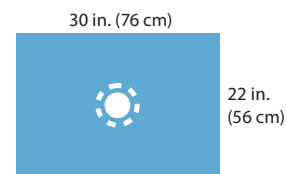

- Fenestration, circular, 0.625 in. (29.5 cm)

### Pediatric Directional Incision Drape

Sterile No.	Nonsterile No.	Qty. Cs
9777	9777N	3



- Fenestration, circular, 4 in. (10 cm)

 Basic drape fabric	 Reinforcements	 Side panel material
 Adhesive	 Incise	 Clear plastic panels, anesthesia screens and pouches

## Pediatric Pack

Nonsterile No.	Description	29490 Pediatric Pack
29496NC	Minor Procedure Drape	1
9545NC	AAMI 3 NonReinforced Surgical Gown, X-Large	2
8520N	Absorbent towel	2
8337N	Mayo stand cover, reinforced poly, 23 in. (58 cm) wide	1
8694-61	Suture bag	1
8554NA	Drape towel, adhesive, nonabsorbent	4
8146N	Outer wrap, reinforced poly table cover, 44 x 90 in. (112 x 228.6 cm)	1
<b>Quantity per case</b>		<b>8</b>



Peri-GYN

Surgical Drapes and Packs

# Peri-GYN

## Surgical Drapes and Packs

# Peri-GYN

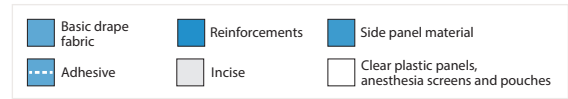

### Abdominal Lithotomy Drape

Sterile No.	Nonsterile No.	Qty. Cs
N/A	29300N	N/A

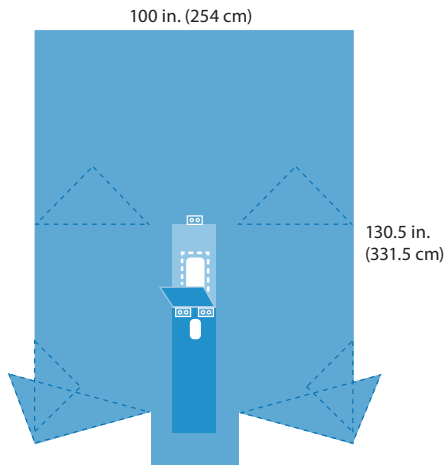

- Absorbent reinforcement, 13.375 x 29 in. (34 x 74 cm)
- Fenestration, abdominal with adhesive, 5.6875 x 12.125 in. (14 x 31cm)
- Fenestration, perineal, 3 x 6 in. (7.5 x 15cm)
- Perineal flap
- Attached leggings
- Cord-holding tabs
- Included in pack 29146

### Laparoscopy Drape

Sterile No.	Nonsterile No.	Qty. Cs
N/A	29402N	N/A

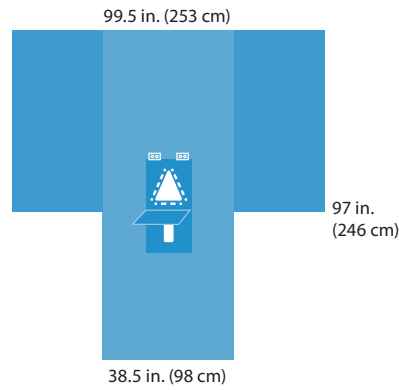

- Absorbent reinforcement, 15.25 x 30 in. (39 x 76 cm)
- Fenestration, triangular abdominal with adhesive, 7.875 x 8.75 in. (20 x 22 cm)
- Fenestration, perineal, 3 x 6 in. (7.5 x 15 cm)
- Perineal flap
- Cord-holding tabs
- Included in pack 29242, 29245

### Laparoscopy/Pelviscopy Drape

Sterile No.	Nonsterile No.	Qty. Cs
N/A	29404N	N/A

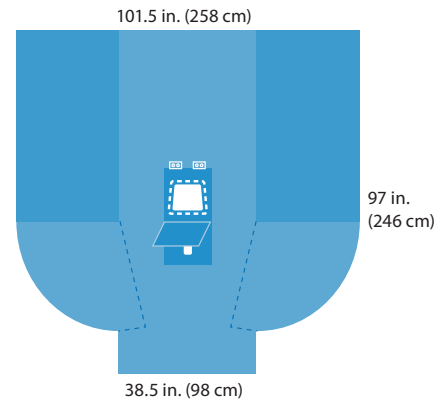

- Absorbent reinforcement, 15.375 x 27 in. (39 x 68.5 cm )
- Fenestration, trapezoidal abdominal with adhesive, 7 x 7 x 9 in. (18 x 18 x 23 cm)
- Fenestration, perineal, 3 x 6 in. (7.5 x 15 cm)
- Perineal flap
- Side gussets for added coverage
- Cord-holding tabs
- Included in pack 29606, 29604

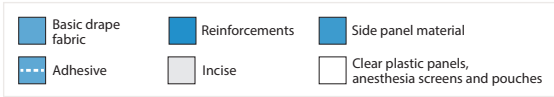

### Laparoscopy/Pelviscopy Drape

Sterile No.	Nonsterile No.	Qty. Cs
29407	29407N	10

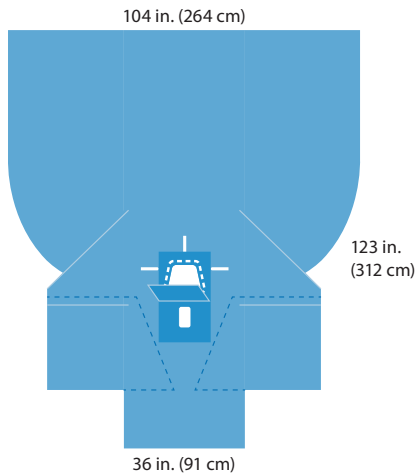

- Absorbent reinforcement, 15.25 x 26.5 in. (39 x 67 cm)
- Fenestration, abdominal with adhesive, 7 x 7 x 7 x 9 in. (18 x 18 x 23 cm)
- Fenestration, perineal, 3 x 6 in. (7.5 x 15 cm)
- Perineal flap
- Armboard covers
- Velcro® Cord-Holding Straps
- Included in pack 29408

### Laparoscopy Drape

Sterile No.	Nonsterile No.	Qty. Cs
N/A	29403N	N/A

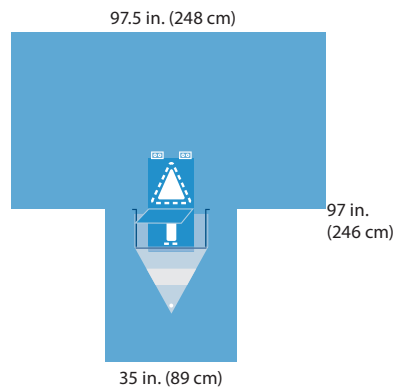

- Absorbent reinforcement, 15.375 x 27 in. (39 x 67 cm)
- Triangular abdominal fenestration with adhesive, 7.875 x 8.75 in. (20 x 22 cm)
- Fenestration, perineal with adhesive, 3 x 6 in. (7.5 x 15 cm)
- Perineal flap
- Fluid control pouch with filtering screen, closed suction port and drawstring, 19¾ x 31 in. (50 x 79 cm)
- Cord-holding tabs
- Included in pack 29503

### Lithotomy Drape

Sterile No.	Nonsterile No.	Qty. Cs
29455	29455NA	8

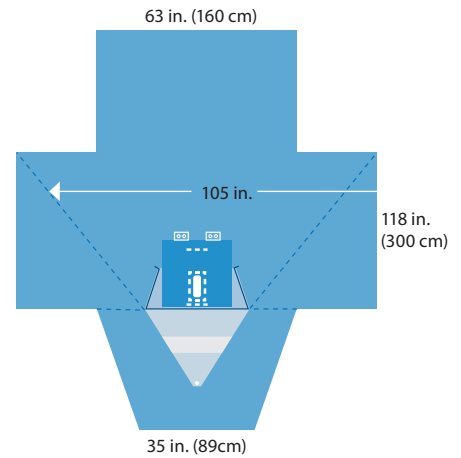

- Absorbent reinforcement, 20.375 x 19 in. (52 x 48 cm)
- Fenestration, perineal with adhesive, 2.5 x 6.5 in. (6 x 16.5 cm)
- Anesthesia screen
- Attached leggings
- Cord-holding tabs
- Fluid control pouch with filtering screen and closed suction port, 22 x 34½ in. (56 x 88 cm)

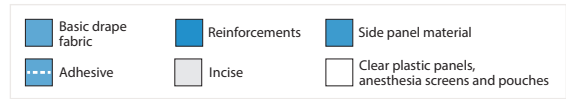

**Lithotomy "T" Drape**

Sterile No.	Nonsterile No.	Qty. Cs
N/A	29438N	N/A

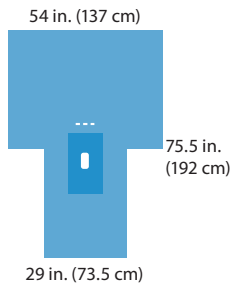

- Absorbent reinforcement, 12 x 20.375 in. (30.5 x 52 cm)
- Fenestration, perineal, 2.5 x 5.5 in. (6 x 14 cm)
- Included in pack 29276

**Lithotomy Drape**

Sterile No.	Nonsterile No.	Qty. Cs
29450	29450N	10

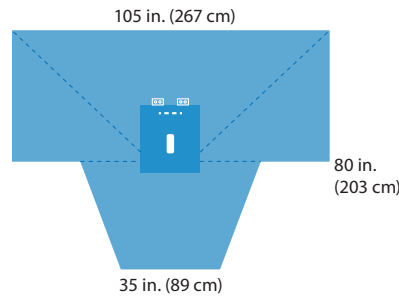

- Absorbent reinforcement, 20.375 x 22 in. (52 x 56 cm)
- Fenestration, perineal, 2.5 x 6.5 in. (6 x 16.5 cm)
- Attached leggings
- Cord-holding tabs
- Included in pack 29170, 29171

**LAVH Drape**

Sterile No.	Nonsterile No.	Qty. Cs
29474	29474NC	8

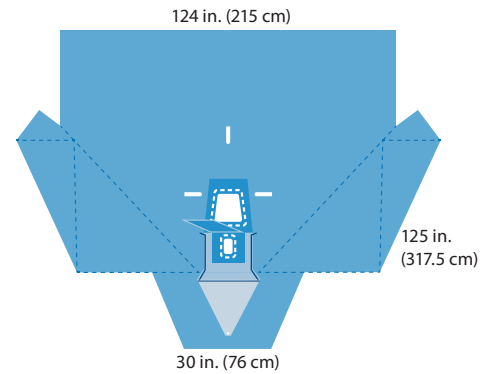

- Absorbent reinforcement, 12 x 19.25 x 16.75 in. (30.5 x 49 x 42.5 cm)
- Trapezoidal abdominal fenestration with adhesive, 7 x 9 x 9 in. (18 x 23 x 23 cm)
- Fenestration, perineal, with adhesive, 3 x 6 in. (7.5 x 15 cm)
- Perineal flap
- Anesthesia screen
- Armboard covers
- Attached leggings with tieback straps
- Fluid control pouch with closed suction port and drawstring, 16½ x 34 in. (42 x 86 cm)
- Velcro® Cord-Holding Tabs
- Included in pack 29475

**Robotic Drape with Attached Leggings**

Sterile No.	Nonsterile No.	Qty. Cs
29574	29574N	8

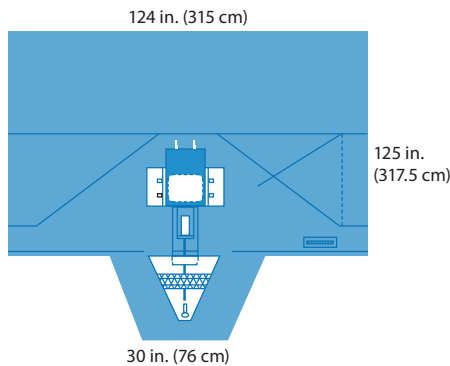





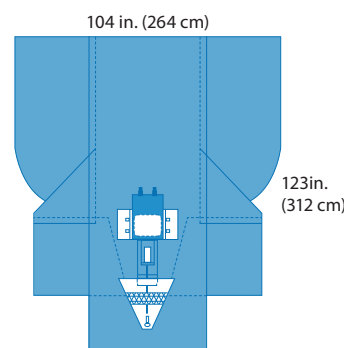

- Absorbent reinforcement, 36.5 x 20.25 in. (92.7 x 51.4 cm)
- Abdominal fenestration with adhesive, 14 x 11 in. (35.5 x 28 cm)
- Perineal fenestration with adhesive, 3 x 6 in. (7.5 x 15 cm)
- Perineal flap
- Attached leggings
- Fluid control pouch with filtering screen and closed port, 25 x 28½ in. (64 x 72 cm)
- Instrument pouches 9 x 20 in (23 x 51 cm)

**Robotic Drape**

Sterile No.	Nonsterile No.	Qty. Cs
29575	29575N	10



- Absorbent reinforcement 36.5 x 20.25 in (92.7 x 51.4 cm)
- Abdominal fenestration with adhesive, 14 x 11 in. (35.5 x 28 cm)
- Perineal fenestration with adhesive, 3 x 6 in. (7.5 x 15 cm)
- Perineal flap
- Fluid control pouch with filtering screen and closed port, 20 x 11 in. (51 x 28 cm)
- Instrument pouches 9 x 20 in (23 x 51 cm)

 Basic drape fabric	 Reinforcements	 Side panel material
 Adhesive	 Incise	 Clear plastic panels, anesthesia screens and pouches

## Surgical Drapes and Packs

# Peri-GYN

### Peri-GYN Packs

Nonsterile No.	Description	29242 Laparoscopy Pack	29245 Laparoscopy Pack	29606 Laparoscopy/Pelviscopy Pack I	29604 Laparoscopy/Pelviscopy Pack II	29408 Laparoscopy/Pelviscopy Pack III	29503 Fluid Control Laparoscopy Pack	29146 Abdominal Lithotomy Pack	29276 Peri-GYN Pack	29170 Peri-GYN Pack	29171 Peri-GYN Pack	29475 LAVH/Laparoscopy Pack	9165 Peri-GYN Pack	9274 Peri-GYN Pack
29438N	Lithotomy "T" Drape with absorbent reinforcement, adhesive							1						
29450N	Lithotomy Drape with absorbent reinforcement, attached leggings								1	1				
29474NC	LAVH Drape											1		
29402N	Laparoscopy Drape with absorbent reinforcement, adhesive	1	1											
29404N	Laparoscopy/Pelviscopy Drape with gussets, absorbent reinforcement, adhesive			1	1									
29407N	Laparotomy/Pelviscopy Drape					1								
29403N	Laparoscopy Drape						1							
29300N	Abdominal lithotomy drape							1						
9359N	Drape sheet, adhesive												1	1
8483N	Under-buttocks drape, reinforced poly		1	1	1	1		1		1	1	1	1	1
90680NB	AAMI 4 Poly Reinforced Scrub Nurse Gown, Large											1		
9040NB	AAMI 4 Poly Reinforced Surgical Gown, X-Large											2		
90270NB	AAMI 3 NonReinforced Scrub Nurse Gown, Large, with towel and wrap		1											
9515NB	AAMI 3 NonReinforced Surgical Gown, Large		1								1			1
8554NA	Drape towel, adhesive, nonabsorbent	1	1		2	2		1	1	1			1	1
8520N	Absorbent towel	1	1					1	1	1			1	1
8421NB	Pair of leggings, X-Large	1	1	1	1	1	1	1					1	1
8694-61	Suture bag	1	1		1	1		1	1	1	1	1	1	1
8337N	Mayo Stand Cover, reinforced poly, 23 in. (58 cm) wide		1		1	1						1		
8146N	Outer wrap, reinforced poly table cover, 44 x 90 in. (111.8 x 228 cm)	1	1		1	1		1					1	1
8149N	Outer wrap, reinforced poly table cover, 44 x 85 in. (111.8 x 216 cm), reinforcement 24 x 85 in. (61 x 216 cm)									1	1			
8143N	Outer wrap, reinforced poly table cover, 50 x 90 in. (127 x 228 cm)											1		
	<b>Quantity per case</b>	<b>10</b>	<b>8</b>	<b>10</b>	<b>10</b>	<b>10</b>	<b>10</b>	<b>8</b>	<b>10</b>	<b>12</b>	<b>5</b>	<b>4</b>	<b>12</b>	<b>10</b>

Peri-GYN



## Surgical Drapes and Packs

# Special procedures



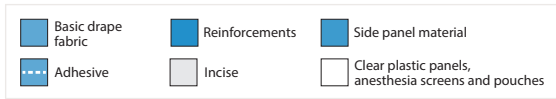

**Minor Procedure Drape**

Sterile No.	Nonsterile No.	Qty. Cs
D1092	D1092NS	25

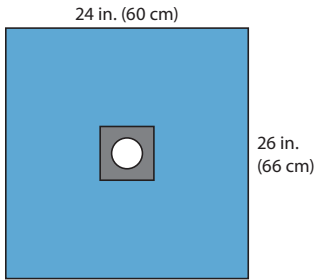

- Aperture, 2.5 in. dia. (6 cm dia.)

**Small Aperture Drape**

Sterile No.	Nonsterile No.	Qty. Cs
C2299*	C2299NS	20

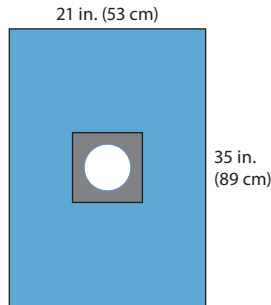

- Absorbent drape material
- Aperture, 5 in. dia. (13 cm dia.)

**Epidural Drape**

Sterile No.	Nonsterile No.	Qty. Cs
C2348*	C2348NS	20

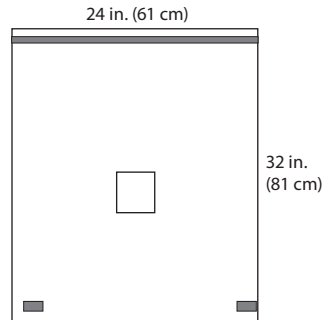

- Aperture, 4 x 4 in. (10 x 10 cm)
- Adhesive strip, 24 x 1 in. (61 x 1 cm)
- Adhesive tabs, (2) 2 x 1 in. (5 x 2.5 cm)

**Special Procedure Sheet**

Sterile No.	Nonsterile No.	Qty. Cs
D2224	D2224NS	20

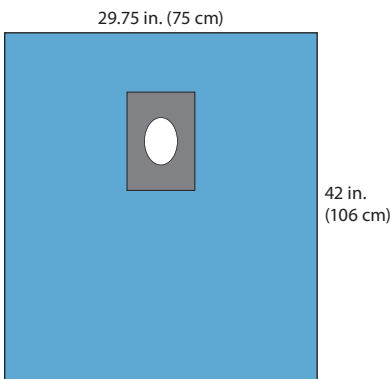

- Absorbent drape material
- Adhesive areas, 8.25 x 10 in. (20 x 15 cm)
- Aperture, 3.5 x 4.5 in. (8 x 11 cm)

**Special Procedure Drape**

Sterile No.	Nonsterile No.	Qty. Cs
C2289*	N/A	20

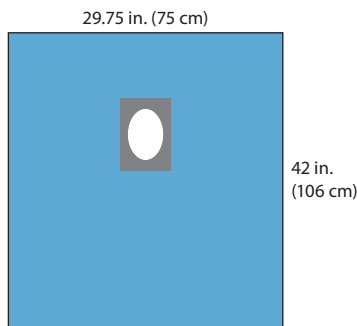

- Absorbent drape material
- Aperture, 4.75 x 6.5 in. (12 x 16 cm)

**Epidural Drape**

Sterile No.	Nonsterile No.	Qty. Cs
C2358*	N/A	20

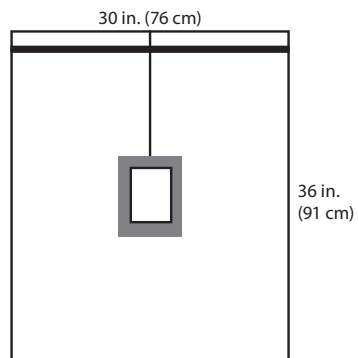

- Aperture, 4 x 6 in. (10 x 15 cm)
- Adhesive strip, 30 x 1 in. (76 x 2.5 cm)

Special procedures

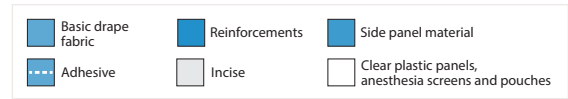

## Fistula Drape

Sterile No.	Nonsterile No.	Qty. Cs
D2264	D2264NS	10

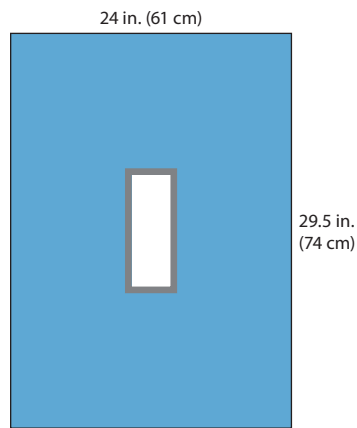

- Absorbent drape material
- Aperture, 3 x 9 in. (8 x 23 cm)



Surgical Drapes and Packs

# Standard packs

## Standard packs

## Setup Packs

## Setup Pack — Sterile No. 114

Nonsterile No.	Contents	Qty. Cs12
8694-61	1 Suture bag	
8337N	1 Mayo stand cover, reinforced poly, 23 in. (58 cm) wide	
8146N	1 Outer wrap, reinforced poly table cover, 44 x 90 in. (111.8 x 228.6 cm)	

## Setup Pack — Sterile No. 117

Nonsterile No.	Contents	Qty. Cs13
8694-61	1 Suture bag	
8337N	1 Mayo stand cover, reinforced poly, 23 in. (58 cm) wide	
8554NA	4 Drape towel, adhesive, nonabsorbent	
8143N	1 Outer wrap, reinforced poly table cover, 50 x 90 in. (127 x 228.6 cm)	

## Setup Pack — Sterile No. 9102

Nonsterile No.	Contents	Qty. Cs12
8694-61	1 Suture bag	
8337N	1 Mayo stand cover, reinforced poly, 23 in. (58 cm) wide	
8186NA	1 Outer wrap, reinforced poly table cover, 60 x 90 in. (165.1 x 228.6 cm), heavy duty	

## General Surgery

## Basic Pack — Sterile No. 9100

Nonsterile No.	Contents	Qty. Cs12
8694-61	1 Suture bag	
8337N	1 Mayo stand cover, reinforced poly, 23 in. (58 cm) wide	
8554NA	4 Drape towel, adhesive, nonabsorbent	
9358NB	1 Fan-Folded Drape Sheet, 40 x 57 in. (101 x 145 cm)	
9349NB	1 Fan-Folded Drape Sheet, 52 x 76 in. (132 x 193 cm)	
8146N	1 Outer wrap, reinforced poly table cover, 44 x 90 in. (111.8 x 228.6 cm)	

## Basic Pack — Sterile No. 9101

Nonsterile No.	Contents	Qty. Cs5
8694-61	1 Suture bag	
8337N	1 Mayo stand cover, reinforced poly, 23 in. (58 cm) wide	
90270NB	1 AAMI 3 NonReinforced Scrub Nurse Gown, Large, with towel and wrap	
9515NB	1 AAMI 3 NonReinforced Surgical Gown, Large	
8146N	1 Outer wrap, reinforced poly table cover, 44 x 90 in. (111.8 x 228.6 cm)	

## General Surgery

### Basic Pack — Sterile No. 9103

Nonsterile No.	Contents	Qty. Cs8
8694-61	1 Suture bag	
8337N	1 Mayo stand cover, reinforced poly, 23 in. (58 cm) wide	
8554NA	4 Drape towel, adhesive, nonabsorbent	
9358NB	1 Fan-Folded Drape Sheet, 40 x 57 in. (101 x 145 cm)	
9349NB	1 Fan-Folded Drape Sheet, 52 x 76 in. (132 x 193 cm)	
90270NB	1 AAMI 3 NonReinforced Scrub Nurse Gown, Large, with towel and wrap	
9515NB	1 AAMI 3 NonReinforced Surgical Gown, Large	
8146N	1 Outer wrap, reinforced poly table cover, 44 x 90 in. (111.8 x 228.6 cm)	

### Basic Pack — Sterile No. 9111

Nonsterile No.	Contents	Qty. Cs5
8694-61	1 Suture bag	
8337N	1 Mayo stand cover, reinforced poly, 23 in. (58 cm) wide	
8554NA	4 Drape towel, adhesive, nonabsorbent	
9349NB	1 Fan-Folded Drape Sheet, 52 x 76 in. (132 x 193 cm)	
90970NA	1 AAMI 3 Fabric Reinforced Scrub Nurse Gown, Large, with towel and wrap	
9511NB	1 AAMI 3 Fabric Reinforced Surgical Gown, Large	
8146N	1 Outer wrap, reinforced poly table cover, 44 x 90 in. (111.8 x 228.6 cm)	
8520N	1 Absorbent towel	

### Basic Pack — Sterile No. 9112

Nonsterile No.	Contents	Qty. Cs10
8694-61	1 Suture bag	
8337N	1 Mayo stand cover, reinforced poly, 23 in. (58 cm) wide	
8554NA	4 Drape towel, adhesive, nonabsorbent	
9349NB	1 Fan-Folded Drape Sheet, 52 x 76 in. (132 x 193 cm)	
8146N	1 Outer wrap, reinforced poly table cover, 44 x 90 in. (111.8 x 228.6 cm)	

### Basic Pack — Sterile No. 9113

Nonsterile No.	Contents	Qty. Cs5
8694-61	1 Suture bag	
8337N	1 Mayo stand cover, reinforced poly, 23 in. (58 cm) wide	
8554NA	4 Drape towel, adhesive, nonabsorbent	
9349NB	1 Fan-Folded Drape Sheet, 52 x 76 in. (132 x 193 cm)	
90270NB	1 AAMI 3 NonReinforced Scrub Nurse Gown, Large, with towel and wrap	
9515NB	1 AAMI 3 NonReinforced Surgical Gown, Large	
8146N	1 Outer wrap, reinforced poly table cover, 44 x 90 in. (111.8 x 228.6 cm)	
8520N	1 Absorbent towel	

## Standard packs

## General Surgery

## Basic Pack — Sterile No. 9114

Nonsterile No.	Contents	Qty. Cs5
8520N	1 Absorbent towel	
8694-61	1 Suture bag	
8337N	1 Mayo stand cover, reinforced poly, 23 in. (58 cm) wide	
8554NA	4 Drape towel, adhesive, nonabsorbent	
9349NB	1 Fan-Folded Drape Sheet, 52 x 76 in. (132 x 193 cm)	
8143N	1 Outer wrap, reinforced poly table cover, 44 x 90 in. (127 x 228.6 cm)	
9010NB	1 AAMI 4 Poly Reinforced Surgical Gown, Large	
90680NB	1 AAMI 4 Poly Reinforced Scrub Nurse Gown, Large	

## Basic Pack — Sterile No. 9131

Nonsterile No.	Contents	Qty. Cs7
8694-61	1 Suture bag	
8337N	1 Mayo stand cover, reinforced poly, 23 in. (58 cm) wide	
90270NB	1 AAMI 3 NonReinforced Scrub Nurse Gown, Large, with towel and wrap	
9515NB	1 AAMI 3 NonReinforced Surgical Gown, Large	
8186NA	1 Outer wrap, reinforced poly table cover, 65 x 90 in. (165.1 x 228.6 cm), heavy duty	

## Universal Packs

## Universal Pack — Sterile No. 9106

Nonsterile No.	Contents	Qty. Cs5
9465N	2 Side Drape, adhesive	
9468N	1 Foot Drape, adhesive	
9467N	1 Head Drape, adhesive	
8520N	1 Absorbent towel	
8337N	1 Mayo stand cover, reinforced poly, 23 in. (58 cm) wide	
8694-61	1 Suture bag	
8146N	1 Outer wrap, reinforced poly table cover, 44 x 90 in. (111.8 x 228.6 cm)	

## Universal Pack — Sterile No. 29107

Nonsterile No.	Contents	Qty. Cs6
29465NB	2 Side Drape with tape	
29469N	1 Foot Drape	
29467NB	1 Head Drape with reinforcement	
90270NB	1 AAMI 3 NonReinforced Scrub Nurse Gown, Large, with towel and wrap	
9515NB	1 AAMI 3 NonReinforced Surgical Gown, Large	
8520N	1 Absorbent towel	
8554NA	4 Drape towel, adhesive, nonabsorbent	
8337N	1 Mayo stand cover, reinforced poly, 23 in. (58 cm) wide	
8694-61	1 Suture bag	
8146N	1 Outer wrap, reinforced poly table cover, 44 x 90 in. (111.8 x 228.6 cm)	

## Universal Packs

### Universal Pack — Sterile No. 29118

Nonsterile No.	Contents	Qty. Cs 6
29669N	1 Foot Drape with adhesive, 77 x 75 in. (195.6 x 190.5 cm)	
29667N	1 Head Drape with adhesive, 72 x 112 in. (182.9 x 284.5 cm)	
29665N	2 Side Drape with tape, 44 x 77 in. (111.8 x 195.6 cm)	
8554NA	4 Drape towel, adhesive, nonabsorbent	
8554NA	1 Mayo stand cover, reinforced poly, 23 in.(58 cm) wide	
8694-61	1 Suture bag	
8146N	1 Outer wrap, reinforced poly table cover, 44 x 90 in. (111.8 x 228.6 cm)	
8520N	1 Absorbent towel	

### Universal Split Pack — Sterile No. 29131

Nonsterile No.	Contents	Qty. Cs4
29440NC	1 Split Drape with absorbent reinforcement	
29351NC	1 Top Drape, absorbent reinforcement	
8554NA	4 Drape towel, adhesive, nonabsorbent	
8337N	1 Mayo stand cover, reinforced poly, 23 in. (58 cm) wide	
8694-61	1 Suture bag	
8143N	1 Outer wrap, reinforced poly table cover, 50 x 90 in. (127 x 228.6 cm)	

### Universal Split Pack II — Sterile No. 29133

Nonsterile No.	Contents	Qty. Cs10
29194N	1 Chest/Breast U-Drape with 29 x 39 in. (73.7 x 99.1 cm) absorbent reinforcement, 12 x 30.5 in. (30.5 x 77.5 cm), split	
29195N	1 Bar Sheet with armboard covers	
8554NA	4 Drape towel, adhesive, nonabsorbent	
8337N	1 Mayo stand cover, reinforced poly, 23 in. (58 cm) wide	
8694-61	1 Suture bag	
8143N	1 Outer wrap, reinforced poly table cover, 50 x 90 in. (127 x 228.6 cm)	

## Laparotomy Packs

### Laparotomy Pack — Sterile No. 29127

Nonsterile No.	Contents	Qty. Cs6
9358NB	2 Fan-Folded Drape Sheet, 40 x 57 in. (101 x 145 cm)	
29410NC	1 Laparotomy Drape with absorbent reinforcement and armboard covers	
9511NB	2 AAMI 3 Fabric Reinforced Surgical Gown, Large	
8554NA	4 Drape towel, adhesive, nonabsorbent	
8520N	3 Absorbent towel	
8337N	1 Mayo stand cover, reinforced poly, 23 in. (58 cm) wide	
8694-61	1 Suture bag	
8146N	1 Outer wrap, reinforced poly table cover, 44 x 90 in. (111.8 x 228.6 cm)	

## Laparotomy Packs

## Laparotomy Pack — Sterile No. 29130

Nonsterile No.	Contents	Qty. Cs4
29410NC	1 Laparotomy Drape with absorbent reinforcement and armboard covers	
90680NB	1 AAMI 4 Poly Reinforced Scrub Nurse Gown, Large	
9010NB	1 AAMI 4 Poly Reinforced Surgical Gown, Large	
8554NA	4 Drape towel, adhesive, nonabsorbent	
8520N	1 Absorbent towel	
8337N	1 Mayo stand cover, reinforced poly, 23 in. (58 cm) wide	
8694-61	1 Suture bag	
8143N	1 Outer wrap, reinforced poly table cover, 50 x 90 in. (127 x 228.6 cm)	

## Laparotomy Pack — Sterile No. 29137

Nonsterile No.	Contents	Qty. Cs6
29410NC	1 Laparotomy Drape with absorbent reinforcement and armboard covers	
9511NB	2 AAMI 3 Fabric Reinforced Surgical Gown, Large	
8554NA	4 Drape towel, adhesive, nonabsorbent	
8520N	2 Absorbent towel	
8337N	1 Mayo stand cover, reinforced poly, 23 in. (58 cm) wide	
8694-61	1 Suture bag	
8146N	1 Outer wrap, reinforced poly table cover, 44 x 90 in. (111.8 x 228.6 cm)	

## Laparotomy Pack — Sterile No. 29138

Nonsterile No.	Contents	Qty. Cs10
29410NC	1 Laparotomy Drape with absorbent reinforcement and armboard covers	
8554NA	4 Drape towel, adhesive, nonabsorbent	
8520N	1 Absorbent towel	
8337N	1 Mayo stand cover, reinforced poly, 23 in. (58 cm) wide	
8694-61	1 Suture bag	
8146N	1 Outer wrap, reinforced poly table cover, 44 x 90 in. (111.8 x 228.6 cm)	

## Laparotomy Pack — Sterile No. 29140

Nonsterile No.	Contents	Qty. Cs4
29410NC	1 Laparotomy Drape with absorbent reinforcement and armboard covers	
9515NB	1 AAMI 3 NonReinforced Surgical Gown, Large	
8554NA	4 Drape towel, adhesive, nonabsorbent	
90270NB	1 AAMI 3 NonReinforced Scrub Nurse Gown, Large, with towel and wrap	
8337N	1 Mayo stand cover, reinforced poly, 23 in. (58 cm) wide	
8694-61	1 Suture bag	
8146N	1 Outer wrap, reinforced poly table cover, 44 x 90 in. (111.8 x 228.6 cm)	



## Laparotomy Packs

### Laparotomy Pack — Sterile No. 29120

Nonsterile No.	Contents	Qty. Cs5
9358NB	2 Fan-Folded Drape Sheet, 40 x 57 in. (101 x 145 cm)	
29411N	1 Laparotomy Drape, absorbent reinforcement	
8554NA	4 Drape towel, adhesive, nonabsorbent	
8520N	1 Absorbent towel	
8337N	1 Mayo stand cover, reinforced poly, 23 in. (58 cm) wide	
8694-61	1 Suture bag	
8146N	1 Outer wrap, reinforced poly table cover, 44 x 90 in. (111.8 x 228.6 cm)	

### Transverse Laparotomy Pack — Sterile No. 29121

Nonsterile No.	Contents	Qty. Cs6
29421NB	1 Transverse laparotomy drape, absorbent reinforcement	
9515NB	1 AAMI 3 NonReinforced Surgical Gown, Large	
90270NB	1 AAMI 3 NonReinforced Scrub Nurse Gown, Large, with towel and wrap	
8554NA	4 Drape towel, adhesive, nonabsorbent	
8520N	1 Absorbent towel	
8337N	1 Mayo stand cover, reinforced poly, 23 in. (58 cm) wide	
8694-61	1 Suture bag	
8146N	1 Outer wrap, reinforced poly table cover, 44 x 90 in. (111.8 x 228.6 cm)	

### General Endoscopy Pack — Sterile No. 9120

Nonsterile No.	Contents	Qty. Cs6
9458NB	1 General Endoscopy Drape	
90270NB	1 AAMI 3 NonReinforced Scrub Nurse Gown, Large, with towel and wrap	
9515NB	2 AAMI 3 NonReinforced Surgical Gown, Large	
8554NA	4 Drape towel, adhesive, nonabsorbent	
7148	10 x-ray detectable sponge, 4 x 4 in. (10.2 x 10.2 cm)	
8337N	1 Mayo stand cover, reinforced poly, 23 in. (58 cm) wide	
8694-61	1 Suture bag	
8146N	1 Outer wrap, reinforced poly table cover, 44 x 90 in. (111.8 x 228.6 cm)	

## Cardiovascular Packs

## CV Pack — Sterile No. 9150

Nonsterile No.	Contents	Qty. Cs4
8694-61	1 Suture bag	
8520N	2 Absorbent towel	
8337N	1 Mayo stand cover, reinforced poly, 23 in. (58 cm) wide	
9541NA	3 AAMI 3 Fabric Reinforced Surgical Gown, X-Large	
8554NA	6 Drape towel, adhesive, nonabsorbent	
9150N	1 CV drape, non-fenestrated	
9349NB	1 Fan-Folded Drape Sheet, 52 x 76 in. (132 x 193 cm)	
8143N	1 Outer wrap, reinforced poly table cover, 50 x 90 in. (127 x 228.6 cm)	

## CV Pack with Reinforced Gowns — Sterile No. 29153

Nonsterile No.	Contents	Qty. Cs3
8694-61	1 Suture bag	
8554NA	6 Drape towel, adhesive, nonabsorbent	
8520N	1 Absorbent towel	
9040NB	2 AAMI 4 Poly Reinforced Surgical Gown, X-Large	
90780NB	1 AAMI 4 Poly Reinforced Scrub Nurse Gown, X-Large, with towel and wrap	
8188NC	1 Overhead table cover with sterile extension	
8470	1 Plastic sheet	
29464N	1 Bottom drape with reinforcement	
29462N	2 Side drapes with tape	
29467NB	1 Head drape with reinforcement (on bottom)	
29468N	1 Foot drape with reinforcement (on top)	
9460	1 Peri-towel	
8143N	1 Outer wrap, reinforced poly table cover, 50 x 90 in. (127 x 228.6 cm)	

## CV Split Pack II — Sterile No. 29163

Nonsterile No.	Contents	Qty. Cs3
8694-61	1 Suture bag	
8337N	1 Mayo stand cover, reinforced poly, 23 in. (58 cm) wide	
9040NB	2 AAMI 4 Poly Reinforced Surgical Gown, X-Large	
90680NB	1 AAMI 4 Poly Reinforced Scrub Nurse Gown, Large	
7554NA	8 Drape towel with adhesive strip, 19 x 30 in. (48.3 x 76.2 cm)	
9163N	1 CV split drape II	
9154N	1 Cardiovascular peri-groin drape, 82 x 75 in. (208.3 x 190.5 cm)	
9349NB	1 Fan-Folded Drape Sheet, 52 x 76 in. (132 x 193 cm)	
8152N	1 Outer wrap/table cover, heavy-duty absorbent, 80 x 110 in. (203.2 x 279.4 cm)	

## Cystoscopy Packs

### Cystoscopy Pack — Sterile No. 29470

Nonsterile No.	Contents	Qty. Cs10
8694-61	1 Suture bag	
8520N	1 Absorbent towel	
9515NA	1 AAMI 3 NonReinforced Surgical Gown, Large	
8421NB	1 Pair of leggings, X-Large	
29437NB	1 Cystoscopy T-drape	
8145N	1 Outer wrap, reinforced poly table cover, 44 x 75 in. (111.8 x 190.5 cm)	

### Cystoscopy Pack — Sterile No. 29471

Nonsterile No.	Contents	Qty. Cs8
8694-61	1 Suture bag	
8520N	1 Absorbent towel	
32474NA	1 AAMI 4 Breathable Surgical Gown, X-Large, X-Long, Specialty	
8421NB	1 Pair of leggings, X-Large	
29437NB	1 Cystoscopy T-drape	
8145N	1 Outer wrap, reinforced poly table cover, 44 x 75 in. (111.8 x 190.5 cm)	

### Cystoscopy Pack — Sterile No. 29480

Nonsterile No.	Contents	Qty. Cs14
8694-61	1 Suture bag	
8421NB	1 Absorbent towel	
8421NB	1 Pair of leggings, X-Large	
29437NB	1 Cystoscopy T-drape	
8145N	1 Outer wrap, reinforced poly table cover, 44 x 75 in. (111.8 x 190.5 cm)	

### Cystoscopy Pack — Sterile No. 29360

Nonsterile No.	Contents	Qty. Cs10
8694-61	1 Suture bag	
8520N	1 Absorbent towel	
29451N	1 Urological Drape	
8145N	1 Outer wrap, reinforced poly table cover, 44 x 75 in. (111.8 x 190.5 cm)	

### Cystoscopy Pack — Sterile No. 9520E

Nonsterile No.	Contents	Qty. Cs10
8694-61	1 Suture bag	
8421NB	1 Pair of leggings, X-Large	
9461N	2 Drape Sheet, square-folded, 38.5 x 39.5 in. (97.8 x 100.3 cm)	
8145N	1 Outer wrap, reinforced poly table cover, 44 x 75 in. (111.8 x 190.5 cm)	

## Standard packs

## Obstetrical Pack

## Obstetrical Pack — Sterile No. 29920

Nonsterile No.	Contents	Qty. Cs6
29357NB	1 Abdominal Cover with absorbent reinforcement	
8421NB	1 Pair of leggings, X-Large	
8483N	1 Under-buttocks drape, reinforced poly	
9355NB	1 Fan Fold Drape 40 x 71 in. (102 x 180 cm)	
8520N	2 Absorbent towel	
8145N	1 Outer wrap/reinforced poly table cover, 44 x 75 in. (111.8 x 190.5 cm), reinforcement 24 x 75 in. (61 x 190.5 cm)	

## Head and Neck Packs

## Head and Neck Pack — Sterile No. 9194

Nonsterile No.	Contents	Qty. Cs6
9556N	1 Head/Bar Drape, adhesive	
9442NA	1 Split Sheet Drape, reinforced, adhesive	
90270NB	1 AAMI 3 NonReinforced Scrub Nurse Gown, Large, with towel and wrap	
9515NB	1 AAMI 3 NonReinforced Surgical Gown, Large	
8554NA	2 Drape towel, adhesive, nonabsorbent	
8520N	1 Absorbent towel	
8337N	1 Mayo stand cover, reinforced poly, 23 in. (58 cm) wide	
8694-61	1 Suture bag	
8146N	1 Outer wrap, reinforced poly table cover, 44 x 90 in. (111.8 x 228.6 cm)	

## Head and Neck Pack — Sterile No. 9196

Nonsterile No.	Contents	Qty. Cs6
9556N	1 Head/Bar Drape, adhesive	
9447NA	1 Large EENT Split Drape	
90270NB	1 AAMI 3 NonReinforced Scrub Nurse Gown, Large, with towel and wrap	
9515NB	1 AAMI 3 NonReinforced Surgical Gown, Large	
8520N	1 Absorbent towel	
8337N	1 Mayo stand cover, reinforced poly, 23 in. (58 cm) wide	
8694-61	1 Suture bag	
8554NA	2 Drape towel, adhesive, non-absorbant	
8146N	1 Outer wrap, reinforced poly table cover, 44 x 90 in. (111.8 x 228.6 cm)	

## HD Lower Extremity Packs

### HD Lower Extremity Pack — Sterile No. 59180

Nonsterile No.	Contents	Qty. Cs6
59405NA	1 HD Extremity Drape	
90270NB	1 AAMI 3 NonReinforced Scrub Nurse Gown, Large, with towel and wrap	
32474NA	1 AAMI 4 Breathable Surgical Gown, X-Large, X-Long, Specialty	
8520N	1 Absorbent towel	
8474N	1 Prep U-drape, 60 x 60 in. (152.4 x 152.4 cm)	
8476NA	1 Prep U-drape, 60 x 72 in. (152.4 x 182.9 cm)	
8694-61	1 Suture bag	
8337N	1 Mayo stand cover, reinforced poly, 23 in. (58 cm) wide	
1582NB	1 Stockinette, 12 x 48 in. (30.5 x 121.9 cm), X-Large	
FG71-2384C	1 Tubing, 6mm x 12 ft.	
3524	3 Drape tape	
8186N	1 Outer wrap, reinforced poly table cover, 65 x 90 in. (165.1 x 228.6 cm), heavy duty	

### HD Arthroscopy Pack — Sterile No. 9197

Nonsterile No.	Contents	Qty. Cs6
59413N	1 HD Arthroscopy Drape	
90270NB	1 AAMI 3 NonReinforced Scrub Nurse Gown, Large, with towel and wrap	
32474NA	1 AAMI 4 Breathable Surgical Gown, X-Large, X-Long, Specialty	
8520N	1 Absorbent towel	
8474N	1 Prep U-drape, 60 x 60 in. (152.4 x 152.4 cm)	
8476NA	1 Prep U-drape, 60 x 72 in. (152.4 x 183 cm)	
8694-61	1 Suture bag	
8337N	1 Mayo stand cover, reinforced poly, 23 in. (58 cm) wide	
1582NB	1 Stockinette, 12 x 48 in. (30.5 x 121.9 cm), X-Large	
FG71-2384C	1 Tubing, 12 ft. x 6 mm	
3524	3 Drape tape	
8186NA	1 Outer wrap, reinforced poly table cover, 65 x 90 in. (165.1 x 228.6 cm), heavy duty	

## Standard packs

## Orthopedic Packs

## General Orthopedic Pack — Sterile No. 29181

Nonsterile No.	Contents	Qty. Cs4
29440NC	1 Split Drape with absorbent reinforcement, adhesive	
29351NC	1 Top Drape with absorbent reinforcement 53 x 99 in. (134.6 x 251.5 cm), adhesive	
9040NB	2 AAMI 4 Poly Reinforced Surgical Gown, X-Large	
8520N	2 Absorbent towel	
8694-61	1 Suture bag	
8337N	1 Mayo stand cover, reinforced poly, 23 in. (58 cm) wide	
8475NA	1 U-Drape, poly, adhesive, 60 x 84 in. (152.4 x 213.4 cm)	
1582NB	1 Stockinette, 12 x 48 in. (30.5 x 121.9 cm), X-Large	
8554NA	4 Drape towel, adhesive, nonabsorbent	
8143N	1 Outer wrap, reinforced poly table cover, 50 x 90 in. (127 x 228.6 cm)	

## Orthopedic Pack — Sterile No. 29182

Nonsterile No.	Contents	Qty. Cs5
9349NB	1 Fan-Folded Drape Sheet, 52 x 76 in. (132 x 193 cm)	
29436NC	1 Split Drape, adhesive	
8694-61	1 Suture bag	
8337N	1 Mayo stand cover, reinforced poly, 23 in. (58 cm) wide	
8476NA	1 Prep U-drape, 60 x 72 in. (152.4 x 182.9 cm)	
8554NA	4 Drape towel, adhesive, nonabsorbent	
A8143N	1 Outer wrap, reinforced poly table cover, 50 x 90 in. (127 x 228.6 cm)	

## Hand and Hip Packs

## Hand Pack — Sterile No. 9419

Nonsterile No.	Contents	Qty. Cs5
29419N	1 Hand Drape	
8694-61	1 Suture bag	
8337N	1 Mayo stand cover, reinforced poly, 23 in. (58 cm) wide	
8476NA	1 Prep U-drape, 60 x 72 in. (152.4 x 183 cm)	
8143N	1 Outer wrap, reinforced poly table cover, 50 x 90 in. (127 x 228.6 cm)	

## Hip Pack — Sterile No. 29187

Nonsterile No.	Contents	Qty. Cs6
29430NB	1 Hip Drape	
9040NB	2 AAMI 4 Poly Reinforced Surgical Gown, X-Large	
8520N	2 Absorbent towel	
8694-61	1 Suture bag	
8337N	1 Mayo stand cover, reinforced poly, 23 in. (58 cm) wide	
8475NA	1 U-Drape, poly, adhesive, 60 x 84 in. (152.4 x 213.4 cm)	
1582NB	1 Stockinette, 12 x 48 in., X-Large (30.5 x 121.9 cm)	
8554NA	2 Drape towel, adhesive, nonabsorbent	
8143N	1 Outer wrap, reinforced poly table cover, 50 x 90 in. (127 x 228.6 cm)	

## Arthroscopic Packs

### Arthroscopy Pack II for Dropped Leg Procedures — Sterile No. 9185

Nonsterile No.	Contents	Qty. Cs6
9414NB	1 Arthroscopy Drape with pouch for dropped leg procedures	
32474NA	1 AAMI 4 Breathable Surgical Gown, X-Large, X-Long, Specialty	
90270NB	1 AAMI 3 NonReinforced Scrub Nurse Gown, Large, with towel and wrap	
8694-61	1 Suture bag	
8337N	1 Mayo stand cover, reinforced poly, 23 in. (58 cm) wide	
8476NA	2 Prep U-drape, 60 x 72 in. (152.4 x 183 cm)	
1586N	1 Stockinette, 9 x 48 in. (22.9 x 121.9 cm), Large	
3524	4 Drape Tape	
8143N	1 Outer wrap, reinforced poly table cover, 50 x 90 in. (127 x 228.6 cm)	

### Arthroscopy Pack — Sterile No. 29180

Nonsterile No.	Contents	Qty. Cs6
29414NC	1 Extremity Drape with absorbent reinforcement	
9040NB	1 AAMI 4 Poly Reinforced Surgical Gown, X-Large	
8520N	1 Absorbent towel	
8694-61	1 Suture bag	
8337N	1 Mayo stand cover, reinforced poly, 23 in. (58 cm) wide	
8476NA	1 Prep U-drape, 60 x 72 in. (152.4 x 183 cm)	
1582NB	1 Stockinette, 12 x 48 in. (30.5 x 121/9 cm), X-Large	
8143N	1 Outer wrap, reinforced poly table cover, 50 x 90 in. (127 x 228.6 cm)	

### Arthroscopy Pack — Sterile No. 29186

Nonsterile No.	Contents	Qty. Cs6
29414NC	1 Extremity Drape with absorbent reinforcement	
32474NA	1 AAMI 4 Breathable Surgical Gown, X-Large, X-Long, Specialty	
90270NB	1 AAMI 3 NonReinforced Scrub Nurse Gown, Large, with towel and wrap	
8694-61	1 Suture bag	
8337N	1 Mayo stand cover, reinforced poly, 23 in. (58 cm) wide	
8476NA	2 Prep U-drape, 60 x 72 in. (152.4 x 183 cm)	
1586N	1 Stockinette, 9 x 48 in. (22.9 x 121.9 cm), Large	
3524	4 Drape tape	
8143N	1 Outer wrap, reinforced poly table cover, 50 x 90 in. (127 x 228.6 cm)	

## Standard packs

## Extremity Packs

## Extremity Pack — Sterile No. 29188

Nonsterile No.	Contents	Qty. Cs5
29414NC	1 Extremity Drape	
8694-61	1 Suture bag	
8337N	1 Mayo stand cover, reinforced poly, 23 in. (58 cm) wide	
8375N	1 Plastic sheet, fan-folded, 44 x 60 in. (111.8 x 152.4 cm)	
8554NA	2 Drape towel, adhesive, nonabsorbent	
8143N	1 Outer wrap, reinforced poly table cover, 50 x 90 in. (127 x 228.6 cm)	

## Extremity Pack — Sterile No. 29189

Nonsterile No.	Contents	Qty. Cs6
29414NC	1 Extremity drape	
8694-61	1 Suture bag	
9040NB	2 AAMI 4 Poly Reinforced Surgical Gown, X-Large	
8520N	1 Absorbent towel	
8337N	1 Mayo stand cover, reinforced poly, 23 in. (58 cm) wide	
8375N	1 Plastic sheet, fan-folded, 44 x 60 in. (111.8 x 152.4 cm)	
8554NA	3 Drape towel, adhesive, nonabsorbent	
8143N	1 Outer wrap, reinforced poly table cover, 50 x 90 in. (127 x 228.6 cm)	

## Shoulder Packs

## Fluid Control Shoulder Pack — Sterile No. 9183

Nonsterile No.	Contents	Qty. Cs3
9360NB	1 Shoulder Drape with attached fluid control pouch, with incise	
9361NB	1 Split Drape, poly reinforced, adhesive	
32474NA	1 AAMI 4 Breathable Surgical Gown, X-Large, X-Long, Specialty	
90270NB	1 AAMI 3 NonReinforced Scrub Nurse Gown, Large, with towel and wrap	
8694-61	1 Suture bag	
8337N	1 Mayo stand cover, reinforced poly, 23 in. (58 cm) wide	
8554NA	4 Drape towel, adhesive, nonabsorbent	
8146N	1 Outer wrap, reinforced poly table cover, 44 x 90 in. (111.8 x 228.6 cm)	

## Fluid Control Shoulder Drape Pack — Sterile No. 29367

Nonsterile No.	Contents	Qty. Cs10
9360NB	1 Shoulder Drape with attached fluid control pouch, with incise	
9361NB	1 Split Drape, poly reinforced, adhesive	

## Shoulder Drape Pack — Sterile No. 29365

Nonsterile No.	Contents	Qty. Cs8
9361NB	1 Split Drape, poly reinforced, adhesive	
29365N	1 Shoulder Drape with incise, adhesive	



## Shoulder Packs

### Shoulder Pack — Sterile No. 29160

Nonsterile No.	Contents	Qty. Cs3
9361NB	1 Split Drape, poly reinforced, adhesive	
29365N	1 Shoulder Drape with incise, adhesive	
32474NA	1 AAMI 4 Breathable Surgical Gown, X-Large, X-Long, Specialty	
90270NB	1 AAMI 3 NonReinforced Scrub Nurse Gown, Large, with towel and wrap	
8520N	1 Absorbent towel	
8694-61	1 Suture bag	
8337N	1 Mayo stand cover, reinforced poly, 23 in. (58 cm) wide	
8476NA	1 U-Drape, poly, adhesive, 60 x 72 in. (152.4 x 183 cm)	
8554NA	4 Drape towel, adhesive, nonabsorbent	
8146N	1 Outer wrap, reinforced poly table cover, 44 x 90 in. (111.8 x 228.6 cm)	

## Pediatric Pack

### Pediatric Pack — Sterile No. 29490

Nonsterile No.	Contents	Qty. Cs8
29496NC	1 Minor Procedure Drape	
9545NC	2 AAMI 3 NonReinforced Surgical Gown, X-Large	
8520N	2 Absorbent towel	
8337N	1 Mayo stand cover, reinforced poly, 23 in. (58 cm) wide	
8694-61	1 Suture bag	
8554NA	4 Drape towel, adhesive, nonabsorbent	
8146N	1 Outer wrap, reinforced poly table cover, 44 x 90 in. (111.8 x 228.6 cm)	

## Laparoscopy Packs

### Laparoscopy Pack — Sterile No. 29242

Nonsterile No.	Contents	Qty. Cs10
29402N	1 Laparoscopy Drape with absorbent reinforcement, adhesive	
8554NA	1 Drape towel, adhesive, nonabsorbent	
8520N	1 Absorbent towel	
8421NB	1 Pair of leggings, X-Large	
8694-61	1 Suture bag	
8146N	1 Outer wrap, reinforced poly table cover, 44 x 90 in. (111.8 x 228.6 cm)	

### Laparoscopy Pack — Sterile No. 29245

Nonsterile No.	Contents	Qty. Cs8
29402N	1 Laparoscopy Drape with absorbent reinforcement, adhesive	
8483N	1 Under-buttocks drape, reinforced poly	
90270NB	1 AAMI 3 NonReinforced Scrub Nurse Gown, Large, with towel and wrap	
9515NB	1 AAMI 3 NonReinforced Surgical Gown, Large	
8554NA	1 Drape towel, adhesive, nonabsorbent	
8520N	1 Absorbent towel	
8421NB	1 Pair of leggings, X-Large	
8337N	1 Mayo stand cover, reinforced poly, 23 in. (58 cm) wide	
8694-60	1 Suture bag	
8146N	1 Outer wrap, reinforced poly table cover, 44 x 90 in. (111.8 x 228.6 cm)	

## Standard packs

## Laparoscopy Packs

## Laparoscopy/Pelviscopy Pack I — Sterile No. 29606

Nonsterile No.	Contents	Qty. Cs10
29404N	1 Laparoscopy/Pelviscopy Drape with gussets, absorbent reinforcement, adhesive	
8483N	1 Under-buttocks drape, reinforced poly	
8421NB	1 Pair of leggings, X-Large	

## Laparoscopy/Pelviscopy Pack II — Sterile No. 29604

Nonsterile No.	Contents	Qty. Cs10
29404N	1 Laparoscopy/Pelviscopy drape with gussets, absorbent reinforcement, adhesive	
8483N	1 Under-buttocks drape, reinforced poly	
8554NA	2 Drape towel, adhesive, nonabsorbent	
8421NB	1 Pair of leggings, X-Large	
8694-61	1 Suture bag	
8337N	1 Mayo stand cover, reinforced poly, 23 in. (58 cm) wide	
8146N	1 Outer wrap, reinforced poly table cover, 44 x 90 in. (111.8 x 228.6 cm)	

## Laparoscopy/Pelviscopy Pack III — Sterile No. 29408

Nonsterile No.	Contents	Qty. Cs10
29407N	1 Laparotomy/Pelviscopy Drape	
8483N	1 Under-buttocks drape, reinforced poly	
8554NA	2 Drape towel, adhesive, nonabsorbent	
8421NB	1 Pair of leggings, X-Large	
8694-61	1 Suture bag	
8337N	1 Mayo stand cover, reinforced poly, 23 in. (58 cm) wide	
8146N	1 Outer wrap, reinforced poly table cover, 44 x 90 in. (111.8 x 228.6 cm)	

## Fluid Control Laparoscopy Drape Pack — Sterile No. 29503

Nonsterile No.	Contents	Qty. Cs10
29403N	1 Laparoscopy Drape	
8421NB	1 Pair of leggings, X-Large	

## Abdominal Lithotomy Pack — Sterile No. 29146

Nonsterile No.	Contents	Qty. Cs8
29300N	1 Abdominal Lithotomy Drape	
8483N	1 Under-buttocks drape, reinforced poly	

## Peri-GYN and Laparoscopy Packs

### Peri-GYN Pack — Sterile No. 29276

Nonsterile No.	Contents	Qty. Cs10
29438N	1 Lithotomy T-drape with absorbent reinforcement, adhesive	
8554NA	1 Drape towel, adhesive, nonabsorbent	
8520N	1 Absorbent towel	
8421NB	1 Pair of leggings, X-Large	
8694-61	1 Suture bag	
8146N	1 Outer wrap, reinforced poly table cover, 44 x 90 in. (111.8 x 228.6 cm)	

### Peri-GYN Pack — Sterile No. 29170

Nonsterile No.	Contents	Qty. Cs12
29450N	1 Lithotomy Drape with absorbent reinforcement, attached leggings	
8483N	1 Under-buttocks drape, reinforced poly	
8554NA	1 Drape towel, adhesive, nonabsorbent	
8520N	1 Absorbent towel	
8694-61	1 Suture bag	
8149N	1 Outer wrap/reinforced poly table cover, 44 x 85 in. (111.8 x 215.9 cm), reinforcement 24 x 85 in. (61 x 215.9 cm)	

### Peri-GYN Pack — Sterile No. 29171

Nonsterile No.	Contents	Qty. Cs5
29450N	1 Lithotomy Drape with absorbent reinforcement, attached leggings	
8483N	1 Under-buttocks drape, reinforced poly	
9515NB	1 AAMI 3 NonReinforced Surgical Gown, Large	
8554NA	1 Drape towel, adhesive, nonabsorbent	
8520N	1 Absorbent towel	
8694-61	1 Suture bag	
8149N	1 Outer wrap/reinforced poly table cover, 44 x 85 in. (111.8 x 215.9 cm), reinforcement 24 x 85 in. (61 x 215.9 cm)	

### LAVH/Laparoscopy Pack — Sterile No. 29475

Nonsterile No.	Contents	Qty. Cs4
29474NC	1 LAVH Drape	
8483N	1 Under-buttocks drape, reinforced poly	
90680NB	1 AAMI 4 Poly Reinforced Scrub Nurse Gown, Large	
9040NB	2 AAMI 4 Poly Reinforced Surgical Gown, X-Large	
8694-60	1 Suture bag	
8337N	1 Mayo stand cover, reinforced poly, 23 in. (58 cm) wide	
8143N	1 Outer wrap, reinforced poly table cover, 50 x 90 in. (127 x 228.6 cm)	

## Standard packs

## Peri-GYN and Laparoscopy Packs

## Peri-GYN Pack — Sterile No. 9274

Nonsterile No.	Contents	Qty. Cs10
9359N	1 Drape sheet, adhesive 38.5 x 56 in. (97.8 x 142.2 cm)	
8483N	1 Under-buttocks drape	
8421NB	1 Pair of leggings, X-Large	
8520N	1 Absorbent towel	
8554NA	1 Non-absorbent towel with adhesive strip	
8694-60	1 Suture bag	
9515NB	1 AAMI 3 NonReinforced Surgical Gown, Large	
8146N	1 Table cover, reinforced poly, 44 x 90 in. (111.8 x 228.6 cm)	

## Peri-GYN Pack — Sterile No. 9165

Nonsterile No.	Contents	Qty. Cs12
9359N	1 Drape sheet, adhesive 38.5 x 56 in. (97.8 x 142.2 cm)	
8483N	1 Under-buttocks drape, reinforced poly	
8421NB	1 Pair of leggings, X-Large	
8520N	1 Absorbent towel	
8554NA	1 Non-absorbent towel with adhesive strip	
8694-60	1 Suture bag	
8146N	1 Outer wrap, reinforced poly table cover, 44 x 90 in. (111.8 x 228.6 cm)	

# Sterile Number Index

114	31, 74	29430	53
117	31, 74	29431	51
119	31	29434	51, 63
1584	11	29435	55
1585	11	29436	51
1586	11	29439	53
1587	11	29440	32, 51
29013	61	29442	42
29063	57	29443	41
29066	57	29444	53
29107	76	29445	51
29118	77	29447	41
29120	37, 79	29448	41
29121	37, 79	29449	41
29127	37, 77	29450	68
29130	37, 78	29452	41
29131	77	29455	29, 67
29133	77	29456	16
29137	37, 78	29458	18
29138	37, 78	29459	16
29140	37, 78	29460	16
29146	69, 88	29461	18
29153	24, 80	29470	29, 81
29154	22	29471	29, 81
29160	58, 87	29474	68
29163	24, 80	29475	69, 89
29170	69, 89	29476	51
29171	69, 89	29480	29, 81
29180	56, 85	29490	64, 87
29181	52, 84	29492	63
29182	52, 84	29494	63
29186	56, 85	29496	35, 63
29187	54, 84	29503	69, 88
29188	56, 86	29510	34
29189	56, 86	29520	16
29242	69, 87	29521	17
29245	69, 87	29522	35
29276	69, 89	29525	17
29350	10	29527	26
29352	32, 58	29529	19
29360	29, 81	29556	16
29365	58, 86	29559	27
29367	58, 86	29560	17
29369	57	29570	18
29405	55	29574	68
29407	67	29575	68
29408	69, 88	29604	69, 88
29411	34	29606	69, 88
29414	55	29668	27
29416	55	29920	42, 82
29417	55	32474	5
29418	39	3520	9
29420	35	3523	9
29421	34	39015	5
29422	35	39019	5
29427	53	39045	5

# Sterile Number Index

39049	5	9071	6
39075	5	9071EL	6
39079	5	9100	31, 74
39099	5	9101	31, 74
59180	50, 83	9102	31, 74
59274	50	9103	31, 75
59352	49	9106	76
59362	50	9111	31, 75
59363	50	9112	31, 75
59368	50	9113	31, 75
59405	49	9114	31, 76
59413	49	9120	37, 79
59427	49	9131	31, 76
59438	49	9133	63
59439	49	9150	24, 80
74210	63	9153	23, 24
7444	44	9154	22
7445	44	9155	22
7550	9	9156	22
7552	9	9157	22
7553	9	9162	23
7554	9	9163	22
8186	13	9165	69, 90
8337	14	9183	58, 86
8339	14	9185	54, 85
8376	13	9194	47, 82
8377	13	9196	47, 82
8378	13	9197	50, 83
8380	13	9274	69, 90
8385	13	9349	10
8420	11	9355	10
8421	11	9358	10
8430	11	9385	13
8433	11	9414	53
8441	44	9418	35
8474	11	9419	54, 84
8475	11	9423	53
8476	11	9428	35
8482	10	9430	34
8483	10	9438	36
8484	10	9439	39
8486	10	9444	10
8487	10	9446	10
89005	5	9447	45
89015	5	9448	39
89045	5	9449	39
89075	5	9450	39
89085	5	9454	12
89095	5	9457	36
9010	6	9458	36
9011	6	94590	36
9011EL	6	9461	10
9040	6	9462	10
9041	6	9464	10
9041EL	6	9505	4
9070	6	9511	4

# Sterile Number Index

9515	4	D1072	12
9518	4	D1089	9
9520E	29, 81	D1092	71
9541	4	D2008A	14
9545	4	D2019	44
9545ELA	4	D2043	46
9548	4	D2114	12
9556	45	D2158	14
9560	6	D2224	71
9562	44	D2244	16
9565	45	D2258	47
9571	4	D2264	72
9575	4	D2286	17
9575EL	4	D2288C	17
9578	4	D2310C	61
9585	4	D2344	19
9599	4	D2355	19
95995	4	D2364	18
95998	4	D2366	19
9777	63	D2399	19
99015	5	D2422	18
99045	5	D5510	12
99075	5	M9471	10
C2289	71	TB9349CE	10
C2299	71	TB9441	45
C2304	61		
C2315	26		
C2324	26		
C2326	12		
C2346	26		
C2348	71		
C2358	71		
C2362	61		
C2411	20		
C2444	20		
D1000	9		
D1010	9		
D1012	14		
D1013	14		
D1014	59		
D1015	11		
D1016	12		
D1017	59		
D1018	11		
D1018L	11		
D1019A	11		
D1020	46		
D1021	46		
D1025	46		
D1030	46		
D1031	47		
D1060	46		
D1061	47		
D1062	44		
D1067	59		
D1071	29		

# Nonsterile Number Index

1582NB	11, 31, 50, 52, 54, 56, 83, 84, 85	29464N	23, 24, 80
1585N	11	29465NB	32, 33, 76
1586N	11, 54, 56, 85	29467NB	23, 24, 32, 33, 76, 80
2058N	27	29468N	23, 24, 80
29013N	61	29469N	32, 33, 76
29063N	57	29474NC	68, 69, 89
29066N	57	29476N	51
29154N	22	29478N	58
29194N	32, 33, 77	29492NB	63
29195N	32, 33, 77	29494N	63
29300N	66, 69, 88	29496NC	35, 63, 64, 87
29350NC	10	29510NB	34
29351NC	32, 33, 52, 58, 77, 84	29520NA	16
29357NB	42, 82	29521NA	17
29365N	57, 58, 86, 87	29522NB	35
29369NB	57	29525NA	17
29402N	66, 69, 87	29527N	26
29403N	67, 69, 88	29529NA	19
29404N	66, 69, 88	29556NC	16
29405NC	55	29557N	27
29407N	67, 69, 88	29559N	27
29410NC	34, 37, 77, 78	29560NC	17
29411N	37, 79	29565N	31
29414NC	55, 56, 85, 86	29570NA	18
29416N	55	29574N	68
29417N	55	29575N	68
29418N	39	29663N	23, 24
29419N	84	29665N	32, 33, 77
29420ND	35	29667N	32, 33, 77
29421NB	34, 37, 79	29668N	27
29422NB	35	29669N	32, 33, 77
29427NC	53, 54	324740NA	5
29430NB	53, 54, 84	32474NA	5, 29, 50, 54, 56, 58, 81, 83, 85, 86, 87
29431N	51	3524	54, 56, 83, 85
29434N	51, 63	3524N	31, 50
29435NB	55	39015NA	5
29436NC	51, 52, 84	39019N	5
29437NB	29, 81	39045NB	5
29438N	68, 69, 89	39049NA	5
29439NB	53	39075NB	5
29440NC	32, 33, 51, 52, 77, 84	39079NB	5
29442NA	42	39099NA	5
29443N	41	59274N	50
29444N	53	59352NA	49
29445NB	51	59362N	50
29447NB	41	59363N	50
29448NB	41	59405NA	49, 50, 83
29449NB	41	59413N	49, 50, 83
29450N	68, 69, 89	59427N	49
29451N	29, 81	59438N	49
29452NC	41	59439N	49
29453NB	42	7148	37, 79
29455NA	29, 67	74210N	63
29456NB	16	7444N	44
29458N	18	7445N	44
29459NB	16	7554NA	9, 24, 80
29460NB	16	8143N	24, 31, 33, 37, 52, 54, 56, 69, 74, 76, 77, 78, 80, 84, 85, 86, 89
29462N	23, 24, 80		



# Nonsterile Number Index

8145N	13, 29, 42, 81, 82	90030NA	6
8145NW	13	9010NB	6, 31, 37, 76, 78
8146N	13, 31, 33, 37, 47, 58, 64, 69, 74, 75, 76, 77, 78, 79, 82, 86, 87, 88, 89, 90	9011ELNB	6
8146NW	13	9011NB	6
8149N	69, 89	90270NB	4, 31, 33, 37, 47, 50, 54, 56, 58, 69, 74, 75, 76, 78, 79, 82, 83, 85, 86, 87
8152N	13, 24, 80	90280NC	4
8181NA	13	90370NB	4
8183N	13	90380NC	4
8184N	13	9040NB	6, 24, 52, 54, 56, 69, 80, 84, 85, 86, 89
8184NW	13	9041ELNA	6
8186N	83	9041NA	6
8186NA	13, 31, 50, 74, 76, 83	90680NB	6, 24, 31, 37, 69, 76, 78, 80, 89
8186NW	13	9070NA	6
8187N	13	9071ELNA	6
8188NC	13, 24, 80	9071NA	6
8189N	13	90780NB	6, 24, 80
8191N	13	90970NA	4, 31, 75
8196NA	13	91070NB	4
8337N	24, 31, 33, 37, 47, 50, 52, 54, 56, 58, 64, 69, 74, 75, 76, 77, 78, 79, 80, 82, 83, 84, 85, 86, 87, 88, 89	9150N	23, 24, 80
8339NA	14	9153N	23
8371NI	13	9154N	22, 24, 80
8375N	56, 86	9155NA	22
8376N	13	9156N	22
8377N	13	9157N	22
8420NB	11	9162N	23
8421NB	11, 29, 42, 69, 81, 82, 87, 88, 89, 90	9163N	22, 24, 80
8430N	11	9349NB	10, 24, 52, 74, 75, 76, 80, 84
8433NA	11	9355NB	10, 42, 82
8441N	44	9358NB	10, 31, 37, 74, 75, 77, 79
8470	24, 80	9359N	69, 90
8474N	11, 50, 83	9360NB	57, 58, 86
8475NA	11, 52, 54, 84	9361NB	52, 57, 58, 86, 87
8476NA	11, 31, 50, 52, 54, 56, 58, 83, 84, 85, 87	9414NB	53, 54, 85
8482N	10	9418N	35
8483N	10, 42, 69, 82, 87, 88, 89, 90	9423NA	53
8484NA	10	9428NC	35
8486NA	10	9430NB	34
8487NA	10	9438NB	36
8520N	9, 24, 29, 31, 33, 37, 42, 47, 50, 52, 54, 56, 58, 64, 69, 75, 76, 77, 78, 79, 80, 81, 82, 83, 84, 85, 86, 87, 89, 90	9439N	39
8554NA	9, 24, 31, 33, 37, 47, 52, 54, 56, 58, 64, 69, 74, 75, 76, 77, 78, 79, 80, 82, 84, 86, 87, 88, 89, 90	9439NB	31
8694-60	87, 89, 90	9441N	45
8694-61	24, 29, 31, 33, 37, 47, 50, 52, 54, 56, 58, 64, 69, 74, 75, 76, 77, 78, 79, 80, 81, 82, 83, 84, 85, 86, 87, 88, 89	9442NA	45, 47, 82
8750NA	10	9444NA	10
890015NA	5	9446NA	10
890045NA	5	9447NA	45, 47, 82
89005N	5	9448N	39
89015NB	5	9449N	39
89045NB	5	9450N	39
89075NA	5	9457N	36
89085N	5	9458NB	36, 37, 79
89095N	5	94590N	36
90020NA	6	9460	24, 80
		9461N	10, 29, 81
		9462N	10
		9465N	32, 33, 76
		9467N	32, 33, 76

# Nonsterile Number Index

9468N	32, 33, 76	D1060NS	46
9511NB	4, 31, 37, 75, 77, 78	D1061NS	47
9515NA	81	D1062NS	44
9515NB	4, 29, 31, 33, 37, 47, 69, 74, 75, 76, 78, 79, 82, 87, 89, 90	D1067NS	59
9518NC	4	D1071NS	29
9541NA	4, 24, 80	D1072NS	12
9545ELNA	4	D1089NS	9
9545NC	4, 64, 87	D1092NS	71
9548NC	4	D2008NS	14
9556N	45, 47, 82	D2019NS	44
9557N	45	D2043NS	46
9560N	6	D2114NS	12
9562N	44	D2158NS	14
9565N	45	D2224NS	71
9575ELNA	4	D2244NS	16
9575NB	4	D2264NS	72
9578NB	4	D2265NSC	18
9585N	4	D2286NS	17
95995N	4	D2288NSC	17
95998N	4	D2294NSC	17
9777N	63	D2310NSC	61
99015N	5	D2344NS	19
99045N	5	D2355NS	19
99075N	5	D2366NS	19
A8143N	84	D2399NS	19
C2299NS	71	D5510NS	12
C2304NS	61	FG71-2384C	50, 83
C2315NS	26	TB29665N	32, 33
C2324NS	26	TB29667N	23, 24, 32, 33
C2325NSA	61	TB29669N	23, 24, 32, 33
C2326NS	12	TB9349NB	10
C2346NS	26		
C2348NS	71		
C2362NS	61		
C2411NS	20		
C2433NS	19		
COOLPACK	7		
COOLVESTL	7		
COOLVESTM	7		
COOLVESTXL	7		
D1000NS	9		
D1010NS	9		
D1012NS	14		
D1013NS	14		
D1015NS	11		
D1016NS	12		
D1017NS	59		
D1018LNS	11		
D1018NS	11		
D1019NS	11		
D1020NS	46		
D1021NS	46		
D1025NS	46		
D1030NS	46		
D1031NS	47		

## C

### Cooling

CoolSource™ Cooling Pack _____	7
CoolSource™ Cooling Vest _____	7

## D

### Drapes

#### Ancillary

Drape Sheets _____	10
Drape Sheet, Square-Folded _____	10
Drape Sheets with Adhesive _____	10
Drape Towels _____	9
Leggings _____	11
Poly U-Drapes _____	11
Pouches _____	11
Stockinettes _____	11
Under-Buttocks Drapes _____	10

#### Ancillary: Drape Accessories

Isolation Bags _____	12
Pouches _____	12

#### Angiography

Angiography Sheet _____	16, 17, 18
Brachial Angiography Drape _____	18
Extra Large Femoral Angiography Drape _____	18
Femoral Angiography Drape _____	16
Femoral Angiography Drape with Catheter Pouch _____	16
Femoral Angiography Drape with Dual Pouches _____	17
Femoral Angiography Drape with Expanded Reinforcement _____	16
Femoral Angiography Drape with Single Pouch _____	17
Femoral Angiography Drape with Trough _____	17
Lulu Radial/Femoral Angio Sheet _____	19
Moveable Multiaccess IR Sheet _____	20
Moveable Radial/Femoral Angio Sheet _____	19
Multiaccess IR Sheet _____	20
Orlando Radial/Femoral Angio Sheet _____	19
Radial/Brachial Drape _____	18
Radial/Femoral Angiography Drape _____	19
Radial/Femoral Angiography Sheet _____	19

#### Cardiovascular

Bottom Drape with Reinforcement _____	23
Cardiovascular Drape _____	23
Cardiovascular Incise Drape _____	22, 23
Cardiovascular Peri-Groin Drape _____	22
Cardiovascular Split Drape _____	22
Cardiovascular Split Drape with Pouches _____	22
Cardiovascular Split Drape with Troughs _____	22
CV Universal Drape Pack _____	23
Head, Side and Foot Drapes _____	23

#### Central Line

Central Line Drape _____	26
Central Line Sheet _____	26
Dressing Change Pouch Organizer _____	27
Full Body Central Line Drape _____	26
Jugular Sheet _____	26
Line Insertion Drape _____	27
Line Insertion Draping System _____	27
PICC Line Insertion Drape _____	27

#### Cystoscopy

Cystoscopy "T" Drape _____	29
Lithotomy Drape with Fluid Control Pouch _____	29
Urological Drape _____	29

#### Equipment

Back Table Covers _____	13
Equipment Covers _____	14
Mayo Stand Covers _____	14

#### General Surgery

Adolescent Laparotomy Drape _____	35
Bariatric Drape _____	36
Chest/Breast Drape _____	35
General Endoscopy Drape _____	36
Laparoscopic Abdominal Drape _____	36
Laparoscopic Cholecystectomy Drape with Pouches _____	35
Laparotomy Drape _____	34
Laparotomy Drape with Pouches _____	34
Laparotomy Incise Drape _____	34
Major Abdominal Drape with Pouches _____	36
Procedure Drape _____	35
Thyroid Drape _____	35
Transverse Laparotomy Drape _____	34
Universal Pack _____	32
Universal Split Pack _____	32

#### Neurosurgery

Craniotomy Drape _____	39
Craniotomy Split Drape _____	39
Neurological Drape _____	39
Universal Spine Drape _____	39

#### Obstetrics

Abdominal Cover _____	42
Cesarean Birth Drape _____	41, 42
Cesarean Birth Drape with Dual Layer Anesthesia Screen _____	41

#### Ophthalmology and EENT

Aperture Drape _____	46
Bar Drape _____	45
EENT Split Drape _____	45
Eye Drape with Pouch _____	45
Head/Bar Drape _____	45
Large EENT Split Drape _____	45
Ophthalmic Aperture Drape _____	47
Ophthalmic Drape _____	44
Ophthalmic Drape with Pouch _____	44
Ophthalmic Incise Drape _____	44, 46, 47
Ophthalmic Incise Pouch _____	46
Small Drape with Adhesive Aperture _____	44
Strabismus Drape _____	46

# Product Index

Orthopedics	
Arthroscopy Drape for Dropped Leg Procedures	53
Arthroscopy Drape with Armboard Covers	53
Beach Chair Shoulder Drape	57
Beach Chair Shoulder Drape with Attachable Pouch	57
Bilateral Limb Drape	55
Extremity Drape	55
Extremity Drape with Armboard Covers	55
Hand Drape	53
Head Sheet	58
Heavy Duty	
HD Arthroscopy Drape	49
HD Dual Split Shoulder Drape	50
HD Extremity Drape	49
HD Hand Drape	49
HD Hip Drape with Pouches	49
HD Shoulder Drape with Pouch	50
HD Split Drape	49, 50
HD Top Drape	49
Hip Drape	53
Hip Drape with Pouches	53
Orthopedic Split Drape	51
Patient Isolation Drape	59
Shoulder Drape	57
Shoulder Pouch	59
Split Drape	51, 52, 57
Split Sheet Drape	51
Top Drape	58
Pacemaker	
Pacemaker Angiography Sheet	61
Pacemaker Drape	61
Pacemaker Sheet	61
Pediatrics	
Circumcision Drape	63
Minor Procedure Drape	63
Neonatal Drape	63
Pediatric Directional Incision Drape	63
Pediatric Drape	63
Split Drape	63
Peri-GYN	
Abdominal Lithotomy Drape	66
Laparoscopy Drape	66, 67
Laparoscopy/Pelviscopy Drape	66, 67
LAVH Drape	68
Lithotomy Drape	67, 68
Lithotomy "T" Drape	68
Robotic Drape	68
Robotic Drape with Attached Leggings	68
Special procedures	
Epidural Drape	71
Fistula Drape	72
Minor Procedure Drape	71
Small Aperture Drape	71
Special Procedure Drape	71
Special Procedure Sheet	71

## G

### Gowns

AAMI Level 3	
Fabric-reinforced surgical gowns	4
Non-reinforced surgical gowns	4
RoyalSilk™ Non-Reinforced Surgical Gowns	4
AAMI Level 4	
Poly-reinforced surgical gowns	6
SmartGown™ Breathable Scrub Nurse Gowns	5
SmartGown™ Breathable Surgical Gowns	5
SmartGown™ Breathable Surgical Gowns with raglan sleeves	5
SmartSleeve™ Poly-Reinforced Breathable Sleeve Surgical Gowns	6

## P

### Packs

Abdominal Lithotomy Pack	88
Arthroscopy Hand and Hip Packs	54
Arthroscopy Pack	85
Arthroscopy Pack II for Dropped Leg Procedures	85
Basic Pack	74, 75, 76
Basic Packs	31
Cardiovascular Packs	24
CV Pack	80
CV Pack with Reinforced Gowns	80
CV Split Pack II	80
Cystoscopy Pack	81
Cystoscopy Packs	29
Extremity Pack	86
Extremity Packs	56
Fluid Control Laparoscopy Drape Pack	88
Fluid Control Shoulder Drape Pack	86
Fluid Control Shoulder Pack	86
General Endoscopy Pack	37, 79
General Ortho Packs	52
General Orthopedic Pack	84
Hand Pack	84
HD Arthroscopy Pack	83
HD Lower Extremity Pack	83
HD Packs	50
Head and Neck Pack	82
Head and Neck Packs	47
Hip Pack	84
Laparoscopy Pack	87
Laparoscopy/Pelviscopy Pack I	88
Laparoscopy/Pelviscopy Pack II	88
Laparoscopy/Pelviscopy Pack III	88
Laparotomy Pack	77, 78, 79
Laparotomy Packs	37
LAVH/Laparoscopy Pack	89
Obstetrical Pack	42, 82
Orthopedic Pack	84
Pediatric Pack	64, 87

# Product Index

Peri-GYN Pack _____	89, 90
Peri-GYN Packs _____	69
Setup Pack _____	74
Setup Packs _____	31
Shoulder Drape Pack _____	86
Shoulder Pack _____	87
Shoulder Packs _____	58
Transverse Laparotomy Pack _____	79
Universal Pack _____	32, 76, 77
Universal Packs _____	33
Universal Split Pack _____	32, 77
Universal Split Pack II _____	77



**We've got you covered**  
from our door to your OR floor

**To order, please contact your Cardinal Health sales representative or call customer service at 800.964.5227**

VELCRO is a registered trademark of Velcro Industries.

© 2023 Cardinal Health. All Rights Reserved. CARDINAL HEALTH, the Cardinal Health LOGO, RESPONSIVEMEMBRANE, SMARTGOWN, ASSIST, SMARTSLEEVE, COOLSOURCE, STRAY AWAY and ROYALSILK are trademarks of Cardinal Health and may be registered in the US and/or in other countries. All other trademarks are the property of their respective owners. Patent cardinalhealth.com/patents. Lit. No. 3GM23-2511759 (09/2023)

