

DCA Vantage[®]

Analyzer

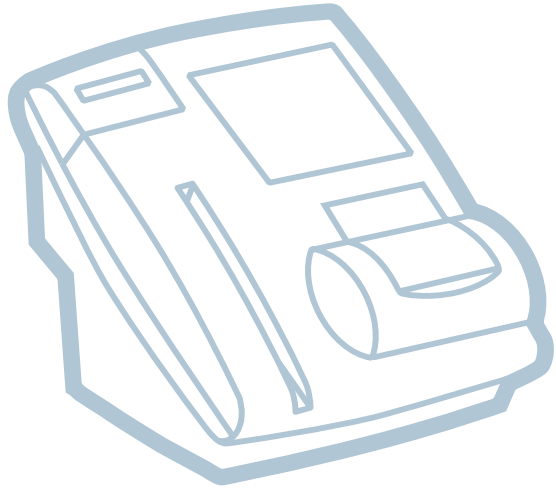

Operator's Guide

REF 10282134



SIEMENS

© 2012–2021 Siemens Healthcare Diagnostics. All rights reserved.

No part of this manual or the products it describes may be reproduced by any means or in any form without prior consent in writing from Siemens Healthcare Diagnostics.

DCA, DCA Vantage, and RAPIDComm are trademarks of Siemens Healthcare Diagnostics.

All other trademarks are the property of their respective owners.

 Origin GB
Siemens Healthcare Diagnostics Inc.
511 Benedict Avenue
Tarrytown, NY 10591-5097 USA

 Siemens Healthcare Diagnostics
Manufacturing Ltd.
Chapel Lane
Swords, Co. Dublin, Ireland
siemens-healthineers.com/poc

Siemens Healthineers
Headquarters
Siemens Healthcare GmbH
Henkestr. 127
91052 Erlangen
Germany
Phone: +49 9131 84-0
siemens-healthineers.com

The information in this manual was correct at the time of printing. However, Siemens Healthcare Diagnostics continues to improve products and reserves the right to change specifications, equipment, and maintenance procedures at any time without notice.

If the DCA Vantage[®] analyzer is used in a manner differently than specified by Siemens, the protection provided by the equipment may be impaired. Observe all warning and hazard statements.

Contents

Using this Guide

Conventions	12
-------------------	----

1 Overview

Intended Use	13
Summary and explanation	13
Hardware Overview	14
Memory	15
Connections and Power	15
Software Overview	17
Screen Components	17
Power Save	17
Menus and Screens	18
Home Screen	18
Viewing Events Notification	18
Help Menu, Software Version, and System Serial Number	18
Turn Off	18
Recall Menu	19
System Menu	20
Additional Settings	20

2 Installation

Hardware Installation	25
Unpacking the System	25
Record the Warranty Information	27
Connect the System Power	28
Installing the Hardware and External Devices	29
Installing the External Barcode Reader	29
Installing Printers	29
Setting up the Onboard Printer	30
Setting up the External Printer	30
Setting up the Report Header	31
Setting up the Report Type	31
Resetting Printer to Default	31
Loading Paper in the Onboard Printer	31
Software Setup	31
Start Up Tests	31
Loading Configuration Settings	32
Verifying that the DCA Vantage System is Ready	32
Optical Test	32

Configuring Connectivity	32
Setting up the Serial Port Connection	33
Setting Baud Rate	33
Setting Parity.....	33
Setting Stop Bits	34
Resetting Serial Port Options to Default	34
Setting up the Ethernet Port	34
Setting the Host Name	35
Setting the IP Address to Automatic or Static Mode	35
Setting the IP Address	35
Setting the Subnet Mask.....	36
Entering a Domain Name Server	36
Entering the Default Gateway	36
Setting up the Remote Computer	36
Setting the Port Number	36
Setting up Auto Send	37
Installing Software.....	38
Installing the Software.....	38
Finalizing the Software Upgrade.....	39

3 Operating the System

Materials Provided.....	41
Special Materials Required (Not Provided)	41
System Access	41
Operator IDs and Access Codes	42
Operator Levels	43
Adding an Operator.....	43
Editing an Operator.....	44
Displaying an Operator	44
Deleting an Operator.....	45
Performing Tests	45
Opening and Inspecting the Reagent Foil Package	45
Opening the Reagent Foil Package	45
Inspecting the Contents of the Foil Package	47
Hemoglobin A1c Test.....	48
Preparing Patient Samples and Controls for Hemoglobin A1c Test	48
Performing a DCA Hemoglobin A1c Test	48
Scanning the Reagent Cartridge.....	54
Inserting the Reagent Cartridge into the System	56
Entering Patient Sample Data.....	57
Entering Patient Information Using the Touchscreen.....	57
Rules for Entering Patient Data Using the Barcode Reader.....	57
Entering Patient Data Using the Barcode Reader	59

Cancelling a test	59
Displaying, Printing, and Sending Results	59
HbA1c Patient Test Results	60
Removing the Reagent Cartridge	62
Microalbumin/Creatinine Test	64
Preparing Patient Samples and Controls for the Microalbumin/Creatinine Test	64
Performing a DCA Microalbumin/Creatinine Test	64
Scanning the Reagent Cartridge.....	70
Inserting the Reagent Cartridge into System	71
Cancelling a test	72
Results of a Microalbumin/Creatinine Test	73
Removing the Reagent Cartridge	75
Recalling Patient Data, Control Tests, and Calibration Data.....	76
Recalling Patient Tests	77
Viewing the Last 10 Patient Tests.....	77
Searching for a Patient ID or Name	77
Searching for a Specific Comment	78
Searching within a Specific Date Range	79
Searching by Result Range	79
Viewing the HbA1c Results in Graph Format	80
Viewing Patient Test Results	80
Editing Patient Data	81
Selecting a Printer.....	81
Configuring GFR for a Patient.....	82
Reports	82
Patient Test Reports	82
Report Components	82
Patient Trend Graph Report	83
Control Test Report.....	83
Calibration Data Report.....	83
Viewing and Printing System Settings Reports	83
4 Calibration	
Overview.....	85
Calibrating for Hemoglobin A1c	85
Calibrating for Microalbumin/Creatinine	87
Calibration Data	88
Viewing Calibration Data Display	88
5 Quality Control	
Collecting Control Specimens	89
Inserting Capillary Holder into the Reagent Cartridge	91
Running a Control Test	92

Quality Control Errors	93
Setting a Required QC Reminder or Displaying a QC Reminder for	
New Reagent Lots	94
Setting a QC Reminder	94
New Lot Reminder	94
Setting a Required QC Reminder	95
Customized QC Reminders	95

6 Maintenance

Routine Cleaning	97
Maintenance Schedule	97
Turning Off the DCA Vantage System	97
Cleaning the Onboard Barcode Reader Window.....	98
Cleaning the External Barcode Reader Window	99
Cleaning the Exterior	99
Removing and Cleaning the Cartridge Spring and Cartridge Area	100
Cleaning the Cartridge Compartment Optical Window	104
Changing the Air Filter	105
Performing Tests	107
Optical Test	107
Optical Test Values	108
System Tests	110
Performing User System Tests	111
Calibrating the Touchscreen	112
User System Test Results.....	112
System Settings.....	112
Loading Paper on the Onboard Printer.....	113
Replacing the Fuse.....	117
Setting Maintenance Reminders.....	119
Viewing System Maintenance Status	120
System Maintenance Log	121
Viewing the Maintenance Log.....	121

7 Troubleshooting

System Messages	123
Troubleshooting the System	126
Troubleshooting Reagent Messages	131
Errors Codes and Corrective Actions.....	131

8 File Management

Exporting Patient Data.....	149
Saving Data and Settings	150
Restoring Data.....	150
Restoring Settings	151
Deleting Data	151

9 Customizing the System

Setting Patient Test Options	153
Setting Patient Data Entry	153
Setting Urine Creatinine Units	153
Setting the HbA1c Reference Range	154
HbA_{1c} Testing and Results	154
Display, Print, and Transmit HbA1c Reference Ranges	155
Designating the Primary and Secondary HbA _{1c} Reporting Units	155
Setting User Corrections	157
Setting the HbA1c User Correction	157
Setting the Albumin User Correction	158
Setting the Creatinine User Correction	158
Setting the GFR Calculation	159
Setting the Patient Recall List Options	160
Setting Patient and Control Test Delete Options	160
Setting Control Test Options	160
Setting Control Tests Data Entry	161
Setting Control Test Reminders	161
Performing Control Tests	162
Control Test Limits	162
Setting a Test Lockout	163
Setting General Options	163
Setting the Language	163
Setting the Time Format and Time	164
Setting the Date Format and Current Date	164
Setting the Sequence Number Options	164
Volume and Display	165
Setting the Sound Volume	165
Setting the System Display	166
Viewing the Current System Settings	166
Viewing and Printing a Partial System Settings Report	166
Printing a Full System Settings Report	166
Customizing Printed Report Headers	166
Setting the Printed Patient Test Report Type	167

Appendix A: Safety Information

Protecting Yourself from Biohazards	169
References	170
External Barcode Reader Beam Safety	170
Electromagnetic Emissions Safety	170

Appendix B: Warranty and Support Information

Legal Information	171
Siemens Authorized Representative.....	171
Warranty Information	171
Installation Details	171
Manufacturer's Warranty	171
Support Information	171
IT Security	172
Disposal of the Analyzer	172
Technical Assistance	172
Training	172
Pre-service Checklist	173

Appendix C: Orderable Supplies

Accessory Items	175
Hemoglobin A1c	175
Microalbumin/Creatinine	175
Replacement Parts	175

Appendix D: Symbols

System and Packaging	177
User Interface	180

Appendix E: Specifications

System Specifications	183
System Dimensions	183
Environmental Specifications	183
Electrical Requirements.....	183
Electrical Precautions	183
Safety Certifications.....	184
Electromagnetic Compatibility (EMC).....	184
Reporting Results Calculations	184
Percent HbA _{1c} Calculation	184
Dual Reporting Calculations – HbA _{1c} and IFCC Units	185
Glomerular Filtration Rate Calculation.....	185
Printed Reports	185
Patient Test Report Contents	185
Patient Trend Graph Report Contents	187
Control Test Report.....	188
System Settings Report.....	190

Appendix F: External Barcode Reader

Specifications	195
Barcode Formats	195
Barcode Symbols and Labels Specifications.....	195
Barcode Symbologies.....	196
Installing the External Barcode Reader	196
Disabling the External Barcode Reader	197
Restoring the Barcode Reader default settings.....	197
Testing the External Barcode Reader.....	197
Maintenance	199
Troubleshooting	199

Appendix G: Computer Interface (LIS)

General Information	201
Ethernet Connections Using POCT1-A	201
Ethernet Connections Using ASTM	202
Serial Connection	202
Architecture.....	203
Hardware Link.....	203
Character Format.....	203
Ethernet Connection	204
Displaying and Printing the MAC address	204
Automatically Sending Data to an LIS	204
Recovery from a Failed Ethernet Connection	206

Appendix H: Glossary

Hardware Terms	207
Software Terms	208
Acronyms	210

Index

Using this Guide



The *DCA Vantage*[®] *Operator's Guide* provides information for physician's office and laboratory professionals who use the DCA Vantage system.

The following table describes how this manual is organized.

If you want to . . .	then refer to . . .
learn about the system principles, the hardware, and the operating sequence,	Section 1, <i>Overview</i> .
install the system and configure connectivity,	Section 2, <i>Installation</i> .
process samples, manage sample results, define security, enter Operator IDs and access codes, and manage reference ranges,	Section 3, <i>Operating the System</i> .
learn about calibration and how to print the calibration status,	Section 4, <i>Calibration</i> .
process Quality Control samples,	Section 5, <i>Quality Control</i> .
perform maintenance activities,	Section 6, <i>Maintenance</i> .
investigate and correct system problems,	Section 7, <i>Troubleshooting</i> .
learn about managing data,	Section 8, <i>File Management</i> .
learn about changing the system settings, system configuration, display the software version and system serial number,	Section 9, <i>Customizing the System</i> .
review additional information, such as the glossary, safety, external barcode reader, or the supplies list,	Appendices.

Conventions

The *DCA Vantage Operator's Guide* uses the following text and symbol conventions:

Convention	Description
 BIOHAZARD	Biohazard statements alert you to potentially biohazardous conditions.
 WARNING	Warning statements alert you to conditions that may cause personal injury.
 CAUTION	Caution statements alert you to conditions that may cause product damage or loss of data.
NOTE:	Note statements alert you to important information that requires your attention.
Bold	<p>Bold type indicates text or icons on the user interface. For example, if the word save appears as Save, it refers to the Save key on the user interface.</p> <p>System icons are also indicated by words in bold type. For example, the words Next Screen refer to a system icon.</p> <p>A complete list of system icons and their equivalents is in Appendix D, <i>Symbols</i>.</p>
<i>Italic</i>	Italic type refers to the title of a document or a section title in this manual.

1 Overview

Intended Use

The DCA Vantage system is a semi-automated, benchtop system. It is designed to quantitatively measure the percent of Hemoglobin A1c in blood and low concentrations of albumin in urine (microalbuminuria), creatinine in urine, and the albumin/creatinine ratio in urine.

The DCA Vantage system is intended for professional use in a physician's office or hospital laboratory. Tests performed using the DCA Vantage system are intended for *in vitro* diagnostic (**IVD**) use. As with all diagnostic tests, do not base a definitive diagnosis on the results of a single test. A physician should make a diagnosis after all clinical and laboratory findings are evaluated.

The system is a spectrophotometer that analyzes the intensity of the light transmitted through the cartridge optical window and reports the results in clinically meaningful units. No calculations are required by the user. When you swipe a calibration card, the barcode reader reads the card and the system automatically performs the calibration.

Summary and explanation

The DCA[®] Microalbumin/Creatinine assay is intended for screening and therapeutic monitoring of microalbuminuria in human urine.

The DCA[®] HbA_{1c} test can be an aid to diagnose diabetes in human blood and to identify patients at risk for developing diabetes. The HbA_{1c} measurements reflect the average blood glucose levels over the preceding three months and are recommended for monitoring and managing control of blood glucose levels.

Hardware Overview

The DCA Vantage system consists of these functional areas:

- reagent cartridge compartment
- onboard barcode reader
- display/touchscreen
- printer

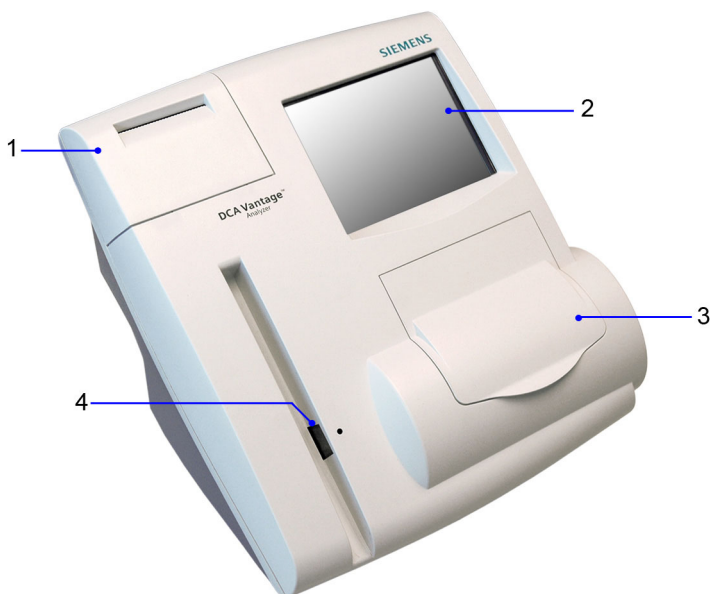

- 1 Printer
- 2 Display Screen
- 3 Reagent Cartridge Compartment
- 4 Onboard Barcode Reader

Figure 1 DCA Vantage System

Interaction with the DCA Vantage system is via an integrated touchscreen. Messages, options, and requests for information display, and responses are made by selecting the appropriate key symbol on the screen.



CAUTION

Do not use anything hard or pointed on the touchscreen. It can damage the touchscreen.

Use the onboard barcode reader to calibrate the system and scan the reagent cartridges and control cards. The reagent cartridges are placed in the reagent cartridge compartment where the tests are run, and when testing is complete, an internal thermal printer prints the test results.

You also can use an external barcode reader to enter certain information into the system.

Memory

The operating system, the system software, the test data, and the system settings for the DCA Vantage system are stored in an onboard (non-removable) flash memory. You can insert a Universal Serial Bus (USB) Flash memory drive into the system's USB port to save data and system settings. You can then insert the USB memory drive into another DCA Vantage system and restore the data to the new system.

You can transfer patient data from one DCA Vantage system to another using the software backup and restore sequences in system settings. See *File Management*, page 149.

NOTE: You cannot import data from a spreadsheet into a DCA Vantage system.

Connections and Power

Ensure that the power cord connects into the power cord receptacle. Turn the system on by pressing the power switch to the On position.

You can connect a USB flash memory drive, a printer, an Ethernet device, and a handheld barcode reader to the system using the interface connectors.



- 1 External Interface Connections
- 2 Power Plug
- 3 Power Switch

Figure 2 Power and External Connections

Software Overview

The DCA Vantage system provides an easy-to-navigate and intuitive user interface.

Screen Components

The DCA Vantage system software screens use a consistent layout.

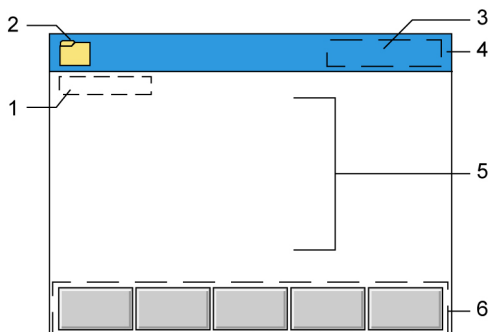

- 1 Screen Title
- 2 Module Icon and Title
- 3 Time and Date
- 4 Title Bar
- 5 Content Area
- 6 Navigation and Contextual Help Button Area

Figure 3 Screen Components

Some options require that you enter information. If selected, a numeric keypad or an alphanumeric keypad displays. An onboard barcode reader is included and reads only barcodes of DCA cartridges and calibration cards. You can use the optional external barcode reader to enter and edit certain patient and control information, as described in Appendix F, *External Barcode Reader*.

NOTE: The DCA Vantage system does not support the connection of an external computer keyboard or a mouse to enter data.

Refer to Appendix D, *Symbols*, for a complete list of key symbols used on the DCA Vantage system.

Power Save

When the system is not in use for more than 30 minutes, Power Save automatically turns on. The system checks to ensure that no tests are in progress and data is not being imported or exported before entering power save. Touch the screen, open a cartridge compartment door or use the internal barcode scanner to resume operations.

Menus and Screens

Home Screen

The Home screen displays after the DCA Vantage system completes its initialization. The Home screen displays the time and date and the state of the system. It is the starting point for Patient and Control Test Sequences.

From the Home screen, you can select:

- Help
- Turn Off
- Recall
- Menu

If the system is in the Not Ready state and you cannot initiate a Patient or Control Test Sequence, an alert message displays explaining why the system is not ready. If the system is in the Ready state, you can start a patient test and scan either an HbA_{1c} or a Microalbumin/Creatinine cartridge.

Notifications or error messages display at the Home screen and provide information about the state of the DCA Vantage system.

Viewing Events Notification

An Event Notification window displays at the Home screen when a maintenance task is due, an error event occurs, or a required or optional control test notification is posted.

1. At the Home screen, select **Events**.
The Events List screen displays the information about the notification.
2. Use the up and down arrows to scroll through the notifications.
3. To return to the Home screen, select **Back**.

NOTE: The Events Notification window closes after you clear all events.

Help Menu, Software Version, and System Serial Number

The Help menu provides information about the DCA Vantage system. The software version number and system serial number also appear on the Home Help screen. To access the Help menu, select **Help** from the Home screen.

Turn Off

You can leave the DCA Vantage system powered on except during maintenance and cleaning procedures. If you need to power off the system, refer to *Turning Off the DCA Vantage System*, page 97.

NOTE: You do not have to reconfigure system settings when turning the power on. The system stores the saved settings.

Recall Menu

The Recall menu provides access to patient test results, control test results, and calibration data.

At the Patient Tests screen, you can recall patient test data and export to a USB device for backup.

To access the Recall menu, select Recall from the Home screen, and select Patient Tests.

Table 1 Patient Tests

Select . . .	then . . .	to . . .
HbA _{1c}	View Last 10	see the last 10 results performed.
	Patient ID/Name	search by Patient ID or last name. You can graph HbA _{1c} results using the Patient ID search. The sort order is the reverse order in which the tests were run. If there is not an entry for a Patient ID or Last Name, the field is blank. You also can delete test results from this screen.
	Date Range	enter a Start and End Date to search patient results for a specific time period.
	Comment 1	search by the first comment of the up to 8 available comments. To perform a wildcard search, use the percent (%) sign at the end the entry.
	Results/Range	Use the Set Lower Limit screen to set the HbA _{1c} search filter value when doing a search by result range. The Lower Search Limit displays in the units of the primary algorithm and cannot be set lower than the following values: <ul style="list-style-type: none"> • NGSP: 2.0% • JDS: 1.7% • mono-S: 1.0% • IFCC: 3 mmol/mol The search returns any test result that is greater than the lower limit set.
	Graph	display HbA _{1c} results in graph format. After searching by patient ID, narrow the search using a date range. The graph displays. You can print the graph to the external printer.

<i>Select . . .</i>	<i>then . . .</i>	<i>to . . .</i>
MicroAlbumin	View Last 10	see the last 10 results performed.
	Patient ID/Name	search by Patient ID or last name. The sort order is the reverse order in which the tests were run. If a Patient ID or Last Name is not entered for the patient, the field will be blank. You also can delete test results. You can use a wildcard (%) character in the recall search.
	Date Range	enter a Start and End Date to search patient results for a specific time period.
	Comment 1	search by the first comment of the up to 8 available comments. To perform a wildcard search, use the percent (%) sign at the end the entry.
Export		copy data to a USB storage device.

System Menu

Select **Menu** from the Home screen to access Control Tests, System Maintenance, System Settings, and System Tests. You can also schedule and change the configuration of control tests.

Table 2 Menu

<i>Select . . .</i>	<i>to . . .</i>
Control Tests	see a read-only status of required and optional Control tests. Select Log to see up to 100 entries.
System Maintenance	view the list of maintenance tasks and the status of each one. A task that has been performed can be selected and marked as complete on this screen. This task also appears on the System Maintenance Log screen.
System Settings	change sound volume, adjust the display contrast, access Additional Settings menu, and view current settings.
System Tests	perform system tests including testing printers, barcode readers, external ports, optical tests, and calibrating the touchscreen.

Additional Settings

Select **Additional Settings** from the System Settings screen to customize the system and add external devices.

To access Additional Settings, select **Menu** from the Home screen, select **System Settings**, and then **Additional Settings**.

Table 3 Additional Settings

<i>Select . . .</i>	<i>then . . .</i>	<i>to . . .</i>
Patient Tests	Data Entry	specify the data and comments that are entered when a patient test is run such as Sample ID, Patient ID, First Name, Last Name, Comments (1–8), Operator ID. You can also indicate if these are optional or required.
	Urine Creatinine Units	set the creatinine results to either mg/dL or mmol/L.
	Reference Range	specify the upper and lower reference range values for HbA _{1c} results. Display, print, and transmit reference range values
	Hb1Ac User Correction	adjust the slope and offset for the HbA _{1c} values.
	Albumin User Correction	adjust the slope and offset for the Albumin values.
	Creatinine User Correction	adjust the slope and offset for the Creatinine values
	GFR Calculation	turn the GFR Calculation on or off, and select the unit of measurement to be used for plasma creatinine.
Patient Recall List Options	set the search criteria and display for patient results. When performing a search in Recall, you can search by either Patient ID or Last Name.	
Control Tests	Data Entry	specify the data and comments that are entered when a control test is run and which data is required or optional.
	Reminders	access to the Control Test Log and allows you to view and change the schedule for the Control Tests.
	New Lot Reminder	set a reminder or require the user to run a control when a new reagent calibration card is scanned.

Select . . .	then . . .	to . . .
Maintenance	Reminders	view the Maintenance Task log. You can also view and change the schedule for maintenance tasks including changing the air filter, cleaning the onboard barcode reader, and cartridge compartment.
General		access screens that configure settings such as language, time, and date that determine what displays on the screen during testing.
	Language	set the display language. The languages are sorted by country code.
	Time	set the current time and time format (12 or 24 hours)
	Date	set the current date and date format.
	Sequence Number	specify whether or not the sequence number resets daily, after 999 entries, or not reset.
	System Access	select restricted, unrestricted, restricted plus, or fully restricted access to the Recall and System Settings features.
	Test Lockout	prevent a patient test from running when there is a control test failure for the current test type. The remove patient test lock function locks out all patient testing and is enabled and disabled from a remote computer.
	Settings Wizard	activate the wizard to run the next time the system is powered on.
	Storage Mode	specify how patient and control tests are deleted from the system; either automatic or manual. Automatic deletion removes tests on a first in-first out basis. Manual deletion requires you to view and delete the tests.
	Save Data and Settings	save data and system settings to a USB device.
	Delete Data	remove the patient information that associates the patient with the test results or delete all patient and test results.
	Restore Data	copy saved data from the USB device to the DCA Vantage system. This overwrites any current data on the system.

Select . . .	then . . .	to . . .
	Restore Settings	copy saved settings from the USB device to the DCA Vantage system. Existing settings are overwritten.
	Install Software	install new software from a USB device to the DCA Vantage system.
Printers	Onboard Printer	enable or disable the onboard printer. You can specify whether reports print automatically and number of copies.
	External Printer	enable or disable an external printer. You can specify whether reports print automatically and number of copies.
	Report Headers	create a customized report header that appears on printed reports.
	Report Type	select whether to print a full report or a short (partial) report (for faster printing).
	Reset Printer Defaults	return the printer settings to the factory settings.
External Barcode Reader		disable or enable the external barcode reader and select the barcode symbology.
Connectivity		select serial or Ethernet port, choose data transmission protocol, and configure port settings.
HbA1c Reporting Units		specify the primary (required) and secondary (optional) reporting units in calculating and displaying the HbA _{1c} value.
Export Log		save error log data to a USB device.
Activate		provide optional capability that is only actionable with an activation code provided by Siemens Healthcare Diagnostics.
Factory Settings		provides authorized service personnel access to screens used to view or set options.

2 Installation

This section provides detailed installation instructions for the DCA Vantage system. Follow the installation steps correctly to ensure proper installation, operation, and service.

Hardware Installation

Place the system where it will not be subjected to extreme temperature variations. Avoid proximity to open windows, direct sunlight, ovens, hot plates, open burners, radiators, and dry ice baths.

Do not place the DCA Vantage system on the same bench as a source of vibration.

Provide bench space large enough to allow free air circulation around the system (8 cm/3 inches on all sides).



CAUTION

Do not drop or handle the system roughly. This can disturb internal calibrated optics and electronics or cause other damage. Always handle the system with care. The DCA Vantage system is a precision system and must be handled accordingly.



CAUTION

The electromagnetic environment should be evaluated prior to operation of the device. Do not use this device in close proximity to sources of strong electromagnetic radiation (e.g. unshielded intentional RF sources), as these can interfere with the proper operation.

Unpacking the System

Your DCA Vantage system is delivered in 1 shipping carton.

1. Carefully remove the contents of the shipping carton.
2. Inspect the carton and system for visible signs of damage.
3. If damage to the system exists, immediately file a complaint with the carrier.
4. Make sure all items are included with your system, and keep them for future use.
 - DCA Vantage system
 - Cleaning Kit

- Optical Test Cartridge (in system cartridge compartment)
- Power Cord for your region
- Air Filter Replacement Kit
- Spare Fuses
- HbA_{1c} Quick Reference Guide
- Microalbumin/Creatinine Quick Reference Guide
- Documentation CD
- Paper Roll
- Self Adhesive Label Stock for onboard printer



Figure 4 DCA Vantage System Parts

5. Retain the shipping carton and packing for several weeks.
If you need to ship the system, the shipping carton provides the best protection against damage.
6. Place the system on a firm, level work surface in the designated work area.
7. Ensure that the system is level, and that the back and sides of the system are at least 8 cm (3 inches) from any adjacent wall.

Record the Warranty Information

1. Print or copy the Pre-service Checklist, and the *Warranty Information*, page 171.
2. Locate the serial number.
 - To find the serial number physically on the system, remove the air filter from the back of the system. The serial number is on a label between the fan and the power connector.
 - To find the serial number from the user interface, select **Menu > System Settings > View Settings**.



- 1 Serial number

Figure 5 Serial Number Location, Air Filter Removed

3. Write the installation date and serial number in the spaces provided in the Pre-service Checklist, and on the *Warranty Information*, page 171.
4. Contact your Siemens representative for your warranty information if the pre-service checklist is not included in your manual.

Connect the System Power

1. Ensure that the system power switch is in the Off position.
2. Connect the power cord to the system and to an appropriate, grounded AC electrical outlet.



- 1 External Connections
- 2 Power Plug
- 3 Power Switch

Figure 6 External Connections and Power Connections

Installing the Hardware and External Devices

If you are connecting an external printer, computer, or LIS system to the DCA Vantage system, you must configure the DCA Vantage system software before connecting the external hardware. Refer to *Configuring Connectivity*, page 32.

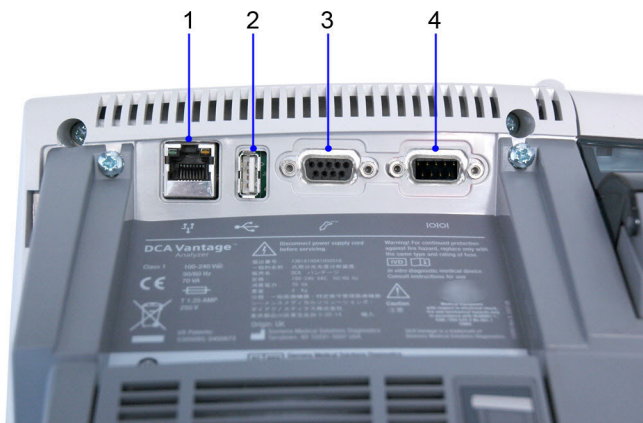

- 1 Ethernet Port (RJ 45)
- 2 USB Port
- 3 Barcode Reader
- 4 Serial Port (RS 232)

Installing the External Barcode Reader

If you ordered an external barcode reader, it is supplied in addition to the internal barcode reader. Refer to Appendix F, *Installing the External Barcode Reader*.

Installing Printers

Use the Printers menu to perform the following tasks:

- enable/disable the onboard and external printer
- configure the onboard and external printer
- enter a customized report header that displays on printed reports
- reset printer defaults
- select the report type

- specify whether a report automatically prints to the onboard printer or external printer, if enabled, or both, when the result displays
- specify the number of copies of the report that you want to print

Setting up the Onboard Printer

1. At the Home screen, select **System Settings**.
2. At the System Settings menu, select **Additional Settings**.
3. At the Additional Settings menu, select **Printers**.
4. Select **Onboard Printer**.

The Onboard Printer screen displays.

- To enable the onboard printer, select **Enable**.
- To disable the onboard printer, select **Disable**.

5. To automatically print the test results, select **Automatically print**.

NOTE: You must select Enabled to automatically print.

6. Use the up and down arrows to select the number of copies of the report you want to print.
7. To save the onboard printer setting, select **Save**.

Setting up the External Printer

The DCA Vantage system supports only Printer Command Language (PCL) type printers for external printers. Network printers are not supported.

1. At the Home screen, select **System Settings**.
2. At the System Settings menu, select **Additional Settings**.
3. At the Additional Settings menu, select **Printers**.
4. Select **External Printer**.
 - To enable the external printer, select **Enable**.
 - To disable the external printer, select **Disable**.
5. To automatically print the test results, select **Automatically print**.

NOTE: You must select Enabled to automatically print.

6. Use the up and down arrows to select the number of copies of the report you want to print.
7. To save the external printer setting, select **Save**.
8. Connect the printer cable to the USB port on the DCA Vantage system and to the external printer.
9. Power on the printer.

Setting up the Report Header

For information about setting up the optional report header, see *Customizing Printed Report Headers*, page 166.

Setting up the Report Type

For information about setting the optional report type, see *Setting the Printed Patient Test Report Type*, page 167.

Resetting Printer to Default

1. At the Home screen, select **System Settings**.
2. At the System Settings menu, select **Additional Settings**.
3. At the Additional Settings menu, select **Printers**.
4. Select **Reset Printer Defaults** to restore the default printer settings.
This also deletes any report header text you have created.

Loading Paper in the Onboard Printer

Install a roll of printer paper for the onboard printer and reinstall the printer cover. Refer to *Loading Paper on the Onboard Printer*, page 113.

The printer stops printing when it runs out of paper. If no paper is available at the start of printing, the printer does not attempt to print.

Software Setup

After the system is properly installed, start the DCA Vantage system by toggling the power button to the On position. The system displays the following information:

- Model Name
- System Software Version
- Copyright Information

Start Up Tests

After you turn the power on, a message displays explaining that the system is starting up. The DCA Vantage system verifies that the compartment door is closed and performs hardware functionality tests to verify that the internal optics and the mechanical system are operating correctly.



CAUTION

Do not turn the system off while it is starting up, this can cause corruption to the stored data.

Loading Configuration Settings

The first time you turn on the DCA Vantage system, the System Settings Wizard runs to help you update configuration settings. The wizard automatically displays the screens that are frequently used to set user preferences such as language, date, and time. Follow the instructions on the screens to enter configuration information.

The System Wizard includes:

- setting current time and time format
- setting current date and date format
- setting sequence number options
- selecting urine creatinine units
- option to finish and proceed to the Home screen or proceed to the System Settings to further configure the system.

The System Settings Wizard only runs the first time you set up the DCA Vantage system. If you want the System Settings Wizard to run the next time the system is turned on, follow these procedures:

1. At the Home screen, select **System Settings**.
2. At the System Settings menu, select **Additional Settings**.
3. At the Additional Settings menu, select **General**.
4. Select **Settings Wizard**.
5. To run the wizard the next time you turn the system on, select **Run System Settings Wizard at Next Power on**.
6. To save this setting, select **Save**.

Verifying that the DCA Vantage System is Ready

The DCA Vantage system displays the current date and time and verifies that no errors occurred. If no errors occurred, the system is ready to run.

Optical Test

Siemens recommends running the optical test cartridge before you analyze samples for the first time. Refer to *Optical Test*, page 107 for more information.

Configuring Connectivity

If you are connecting the DCA Vantage system to a computer or LIS, you must choose the serial or Ethernet port before connecting to these external devices.

NOTE: Data transmission to a computer or LIS can only be active on one type of port (Ethernet or serial) at a time.

For both serial and Ethernet connections, if you change a baud rate, IP address, or port number in the port settings menu, then click **Back** to go to the Connectivity screen, you must select **Save** to make the changes to the port settings take effect on the DCA Vantage system. Otherwise, the previous setting remain in effect.

Setting up the Serial Port Connection

Use the Connectivity menu to enable the serial port and to select options for the serial port.

NOTE: The default setting for the serial port is disabled.

NOTE: You must select Save on all of the screens to save your changes.

1. At the Home screen, select **System Settings**.
2. At the System Settings menu, select **Additional Settings**.
3. At the Additional Settings menu, select **Connectivity**.
4. Select **Serial**.
ASTM automatically selects.
5. Select **Configure** to continue setting Serial Port options.
The Serial Port options menu displays.

Setting Baud Rate

1. At the Serial Port menu, select **Baud Rate**.
2. At the Baud Rate screen, select one of the following:
 - 19,200 bps
 - 9600 bps
 - 4800 bps
 - 2400 bps

The default value is 9600 bps.

3. Select **Save**.
The Serial Port menu displays.

Setting Parity

1. At the Serial Port screen, select **Parity**.
2. Select one of the following parity settings:
 - None
 - Even
 - Odd

The default value is None.

3. Select a string length for the data bits:
 - 8
 - 7

The default value is 8.

4. To save the parity settings, select **Save**.
The Serial Port menu displays.

Setting Stop Bits

1. Select **Stop Bits** to set the number of stop bits.
2. Select a stop bit length:
 - 1
 - 2

The default value is 1.
3. To save the Stop Bits settings, select **Save**.
The Serial Port menu displays.
4. Select **Back** to return to the Connectivity screen.
5. Select **Save** to save the Connectivity settings.

Resetting Serial Port Options to Default

To reset the Serial Port options to the factory default settings:

1. At the Home screen, select **System Settings**.
2. At System Settings, select **Additional Settings**.
The Additional Settings menu displays.
3. At the Additional Settings menu, select **Connectivity**.
4. Select **Serial**.
ASTM automatically selects.
5. Select **Configure**.
6. Select **Reset Defaults**.

Setting up the Ethernet Port

Use the Ethernet Port menu to access the system setting to configure Ethernet communication.

Use the Connectivity menu to enable and disable the Ethernet port. You can access the screen to select different options for the Ethernet port.

NOTE: The default setting for the Ethernet port is disabled.

1. At the Home screen, select **System Settings**.
2. At the System Settings menu, select **Additional Settings**.

3. At the Additional Settings menu, select **Connectivity**.
4. Select **Ethernet**.
5. Select **POCT1A** or **ASTM**.
The default is POCT1A.
6. Select **Configure** to continue setting Ethernet Port options.

Setting the Host Name

Use the Host Name screen to enter the alphanumeric name used to identify the DCA Vantage system on the network.

1. At the Ethernet Port screen, select **Host Name**.
2. Use the alphanumeric keypad to enter the host name.
3. Select **Save** to save the Host Name information.
The Ethernet Port menu displays.

Setting the IP Address to Automatic or Static Mode

You can configure the system with either Automatic or Static IP settings. If you select Automatic IP Setting, IP Address, Subnet Mask, and Default Gateway selections are unavailable.

If you are using Static IP, you must configure the following settings:

- IP Address
 - Subnet Mask
 - Domain Name Server
 - Default Gateway
 - Remote Computer
1. At the Ethernet Port menu, select **Automatic IP Setting** or **Static IP Setting**.
The default is Automatic IP.
 2. To save the IP setting, select **Save**.
The Ethernet Port menu displays.

Setting the IP Address

If you are using Static IP, use the IP Address screen to enter the static IP address for the Ethernet port.

1. At the Ethernet Port menu, select **IP Address**.
2. Use the alphanumeric keypad to enter the IP address.
3. To save the IP address, select **Save**.
The Ethernet Port menu displays.

Setting the Subnet Mask

Use the Subnet Mask screen to enter the subnet mask for the system.

1. At the Ethernet Port menu, select **Subnet Mask**.
2. Use the numeric keypad to enter the subnet mask.
3. To save the subnet mask, select **Save**.

The Ethernet Port menu displays.

Entering a Domain Name Server

Use the Domain Name Server screen to enter the Domain Server Name for the system.

1. At the Ethernet Port menu, select **Domain Server Name**.
2. Select **Domain Name Server**.
3. Use the alphanumeric keypad to enter the DNS.
4. To save the domain server name, select **Save**.

The Ethernet Port menu displays.

Entering the Default Gateway

Use the Default Gateway screen to enter the default gateway for the system.

1. At the Ethernet Port menu, select **Default Gateway**.
2. Use the numeric keypad to enter the default gateway.
3. To save the default gateway, select **Save**.

Setting up the Remote Computer

Use the Remote Computer screen to enter the IP address or host name for the remote computer. After you enter the IP address or host name, you can communicate with the remote computer over the network.

1. At the Ethernet Port menu, select **Remote Computer**.
2. Select **Remote Computer**.
3. Use the alphanumeric keypad to enter one of the following for the remote computer:
 - IP address
 - host name
4. To save the remote computer, select **Save**.

Setting the Port Number

Use the Port Number screen to enter the port number for the system.

1. At the Ethernet Port menu, select **Port Number**.

2. Use the numeric keypad to enter the Port Number.
3. To save the Port Number, select **Save**.

Setting up Auto Send

When you have enabled communications with an LIS, you can configure the system to automatically send all patient and control test results to the LIS as soon as the test result has completed, or as soon as you have finished entering or modifying patient demographic data. Automatic sending of results (Auto Send) to an LIS is disabled by default. For more information about Auto Send, see *Automatically Sending Data to an LIS*, page 204.

To enable Auto Send, perform the following procedure:

1. From the Home screen, select **Menu > System Settings > Additional Settings > Connectivity**.
2. Select the type of connection, **Ethernet** or **Serial**, and the protocol, **ASTM** or **POCT1A**.
3. To enable Auto Send, select the **Automatically Send** check box.
This selection is disabled by default.
To enable manually sending selected results, clear this check box.
4. Select **Configure** to set up the Ethernet or Serial port connection.
NOTE: At this stage, the system does not verify whether a connection exists.
5. Continue configuring the Ethernet or Serial connection parameters.
6. When finished, select **Save**.

The Auto Send setting is included in the backup and restore data so an administrator can copy the settings from one DCA system to another.

Installing Software



CAUTION

If you are upgrading from Version 1.0 or 1.1 to the latest software version, read the following important information:

- During the upgrade, the analyzer deletes the patient, control, and calibration data. Before you upgrade the software, print the patient test data and the control test data, if needed. Consider exporting the data to a USB device. For details, see *Exporting Patient Data*, page 149. The system exports the data to a .txt file. You can view the data in a text file or worksheet.
- Because of the number and complexity of changes in the software between Version 1.1 and the latest software version, the system cannot retain certain system settings across the upgrade process. The system resets the values for HbA_{1c} User Corrections, HbA_{1c} Reference Range, and HbA_{1c} Reporting Units to the default values. For the HbA_{1c} reporting units, Primary is NGSP and Secondary is None.
- Before you upgrade the software, print the Full System Settings report. To do so, on the Home screen, select **Menu > System Settings > Additional Settings**, and select **Print**. After the upgrade, print the report again. Compare the report to the report you printed before the upgrade. Change the system settings, if needed.

NOTE: If you are upgrading from Version 2.0 or higher to the latest software version, the HbA_{1c} reporting units are retained.

Installing the Software

NOTE: If upgrading from Version 4.5, or reinstalling Version 4.6, you may be prompted for an upgrade code. Please contact your technical support provider or distributor.

To start the software upgrade, perform these steps:

1. On the Home screen, select **Menu**.
2. Select **System Settings > Additional Settings**.
NOTE: If security is set on the analyzer, to display the Additional Settings screen, enter an authorized Supervisor ID or access code.
3. If you want to print the Full System Settings Report, be sure the printer is enabled and select **Print**. Otherwise, continue with step 4.
4. Select **General**.
5. Select the down arrow 3 times.
6. Select **Install Software**.

7. Insert the USB storage device into the USB port.



CAUTION

Do not remove the USB storage device from the USB port or turn off the system while the software is installing. This can corrupt the data on the analyzer.

8. Select **Next**.

On the Install Software screen, a message indicates the system is installing the software.

When installation completes, a message instructs you to leave the USB device in the USB port and restart the system

9. To restart the system, select **Restart**.

Finalizing the Software Upgrade

1. After the DCA Vantage analyzer restarts, if prompted to calibrate the touch screen, follow the on screen instructions.

NOTE: If you are upgrading from a version prior to Version 4.0, please continue to step 2. If you are upgrading from Version 4.0 or above, please continue to step 6.

2. At the prompt for using the analyzer in Japan, select **Yes** or **No**.
3. If you selected Yes, follow these steps. If you selected No, continue to step 4.
 - a. On the Report Type - Patient Results screen, select **Full Report** or **Short Report** and select **Next**.
 - b. On the HbA_{1c} Reporting Units screen, select the primary and secondary reporting units and select **Next**.
 - c. Continue to step 4.
4. On the Set System Time screen, select the format and time and select **Next**.
5. On the Set System Date screen, select the format and date and select **Next**.

A list of key software changes displays. This list appears only the first time the analyzer restarts. To navigate the list, use the up and down arrows.
6. On the Install Complete screen, to display the Home screen, select **Back**.
7. Remove the USB device.

8. Print and compare the system settings:
 - a. To print the Full System Settings report, on the Home screen, select **Print**.
 - b. Compare the report to the report you printed before the upgrade.
 - c. Change any system settings, if needed.

3 **Operating the System**

Materials Provided

DCA Vantage System

Special Materials Required (Not Provided)

- DCA Systems HbA_{1c} Reagent Kit
- DCA Systems HbA_{1c} Control Kit
- DCA Systems HbA_{1c} Capillary Holders

System Access

You can set up the DCA Vantage system to have unrestricted or restricted system access.

There are 4 types of system access:

- Unrestricted (default)
- Restricted
- Restricted Plus
- Fully Restricted

If the system is unrestricted, most features are available to an operator without having to enter an access code.

With Restricted, Restricted Plus, and Fully Restricted, some features require an access code to continue or are blocked from an operator.

After setting up the System Access level, you can manage Operator IDs and set up the access to features by individual operators. The access to features is controlled by the Operator Level (Levels 1, 2, and 3). Level 1 is the highest level, typically for a supervisor or system administrator. Levels 2 and 3 are more restrictive and are typically for an operator running daily tests and maintenance activities. Refer to page 42 for system access and operator access levels.

When you assign the security access for the system and the level of access to an operator, you can control the features that the operator can access. When the system access is set to one of the protected modes, the system displays a sign-in screen before the System Settings screen displays. When the system is set to fully restricted, the system displays a sign-in screen before the Recall screen. Operators must enter an access code to continue. If an operator is assigned a level that cannot access a function, a message appears indicating that the operator cannot access that feature.

To access the System Access screen:

1. At the Home screen, select **System Settings**.
2. At the System Settings screen, select **Additional Settings**.
3. At the Additional Settings Screen, select **General**.
4. At the General Screen, select **System Access**.

Operator IDs and Access Codes

Function	Fully Restricted			Restricted Plus			Restricted			Unrestricted		
	L1	L2	L3	L1	L2	L3	L1	L2	L3	L1	L2	L3
Run Patient Test												
Run QC Test												
Recall Patient, QC, or Calibration data												
Edit and Delete Recalled Patient/QC data												
Run System Tests												
Set HbA _{1c} Reporting Units												
Set Japanese Mode												
Configure System Settings												

By default, the system access is Unrestricted. In this mode, the Operator button is always available. Selecting the Operator button displays a new screen that enables you to add, edit, and delete operators.

NOTE: The term Operator ID replaces the term User ID used in earlier versions of DCA Vantage software.

You can add up to 1000 operators. Each Operator ID and access code must be unique. When system access is set to Fully Restricted or Restricted Plus, the operator enters his or her access code to continue. The system auto-populates the Operator ID data entry item according to the user's entered password (Access Code or Support ID of the Day) when the following conditions are true:

- Patient or control test is being run
- System access is configured as Fully Restricted or Restricted Plus mode
- User has been authenticated after entering a valid password

Operator Levels

- Level 1 – All functions
Provides access to all functions on the system.
- Level 2
- Level 3

Level 1 is the highest level, typically for a supervisor or system administrator. Levels 2 and 3 are more restrictive and are typically for an operator running daily tests and maintenance activities.

Adding an Operator

The system verifies that a Level 1 operator is configured in the system. If not, you will be prompted to add this operator first. At the initial system installation, there are no operators or access codes created.

The first operator added to the system must be a Level 1 operator. There must be at least one Level 1 operator on the system at all times. The system prevents the last Level 1 operator from being deleted, or the level changed.

The access code field is alphanumeric with the alpha characters entered as uppercase A–Z and 0–9. The access code can be up to 13 characters.

1. At the Home screen, select **Menu**.
2. Select **System Settings** from the Menu screen.
3. At the System Settings menu, select **Additional Settings**.
4. Select **General**.
5. Select **System Access**.
6. Select the system access level (Unrestricted, Restricted, Restricted Plus, or Fully Restricted).
The Operator button enables after selecting a system access level.
7. Select **Operator**.

8. To add an operator, select **ADD**.
Use the alphanumeric keypad or external barcode reader to enter an Operator ID in the Name field. The Operator ID can include letters and numbers. The maximum number of characters for an Operator ID is 16.
9. Select **Enter** to save the Operator ID.
10. To add an access code, select **Edit** to the right of the ID field.
Use the alphanumeric keypad or external barcode reader to enter an access code.
11. Select **Enter**.
12. At the Add Operator screen, select **Save**.
The operator information is saved.

Editing an Operator

You can change the Operator ID, access code, and level for an operator.

1. At the Home screen, select **Menu**.
2. Select **System Settings** from the Menu screen.
3. At the System Settings menu, select **Additional Settings**.
4. Select **General**.
5. Select **System Access**.
6. At the System Access menu, select **Operators**.
The Operators screen displays.
7. Highlight the operator you want to edit.
8. Select **Edit**.
9. Edit the Operator ID or the Access code with the keypad or external barcode reader.
10. Select **Save**.

Displaying an Operator

1. At the Home screen, select **Menu**.
2. Select **System Settings** from the Menu screen.
3. At the System Settings menu, select **Additional Settings**.
4. At the Additional Settings menu, select **General**.
5. Select **System Access**.
6. At the System Access menu, select **Operators**.
A list of operators displays.

Deleting an Operator

1. At the Home screen, select **Menu**.
2. Select **System Settings** from the Menu screen.
3. At the System Settings menu, select **Additional Settings**.
4. At the Additional Settings menu, select **General**.
5. Select **System Access**.
6. At the System Access menu, select **Operators**.
A list of operators displays.
7. Highlight the Operator ID you want to delete.
8. Select **Delete**.
A message displays verifying that you want to delete the Operator ID.
9. Select **Yes** to delete the Operator ID.

Performing Tests

You can test blood for the percent concentration of HbA_{1C}, and urine for concentrations of microalbumin and creatinine. Results are available in approximately 7 minutes.

Opening and Inspecting the Reagent Foil Package

Before running an HbA_{1C} test or Microalbumin and Creatinine test, open and inspect the contents of the Reagent Cartridge foil package.

Opening the Reagent Foil Package

1. Remove one foil package (containing a reagent cartridge) from storage.
For more information, see *Recommended Procedures for Handling Reagent Cartridges* in the DCA Systems Reagent Kit package insert.

2. Open the foil package as shown in Figure 7.



CAUTION

Do not use scissors to cut open the foil package. Scissors can damage the reagent cartridge, the flexible plastic pull-tab on the cartridge, or the desiccant bag.



Figure 7 Opening Reagent Cartridge Package

3. Remove the contents of the package.

Inspecting the Contents of the Foil Package

The foil package includes the contents displayed below:



CAUTION

When handling the reagent cartridge, do not touch or otherwise contaminate the optical window as this may generate error codes during testing.



- 1 Flexible Pull-tab
- 2 Reagent Cartridge
- 3 Desiccant bag
- 4 Optical Window

Figure 8 DCA Systems Reagent Cartridge Package

Discard the reagent cartridge if any of the following conditions exist:

- The cartridge is damaged.
- The flexible pull-tab is loose or missing.
- The desiccant bag is missing or open.
- Loose desiccant particles are found inside the foil package.
- If the foil package is open for more than 60 minutes.

Hemoglobin A_{1c} Test

The following section explains the test sequence for an HbA_{1c} test.

Preparing Patient Samples and Controls for Hemoglobin A_{1c} Test

Materials Required:

- DCA Systems Hemoglobin A_{1c} Reagent Kit (for use with the DCA Vantage system)
- Patient sample
- Control Kit or other control
- Lint-free tissue
- Clock or timer

For information on preparing controls, refer to *Quality Control*, page 89.

For information on calibrating, refer to *Calibrating for Hemoglobin A_{1c}*, page 85.

Performing a DCA Hemoglobin A_{1c} Test



BIOHAZARD

Wear personal protective equipment, including safety glasses and gloves. Use universal precautions. Refer to *Safety Information*, page 169, for recommended precautions when working with biohazardous materials.

NOTE: You can save unused capillary holders and use them with any lot of DCA Hemoglobin A_{1c} reagent cartridges.

1. Open and inspect the Reagent Cartridge Foil Package.
2. Open the plastic wrap of the capillary holder by tearing the wrap at the serrated edge with the arrow.
3. Inspect the capillary holder for the presence of the following parts:
 - absorbent pad
 - glass capillary
 - latching mechanism

If the capillary holder is missing any of the above parts or is damaged, discard the capillary holder.

Fill the capillary using blood from either a finger stick or venipuncture.

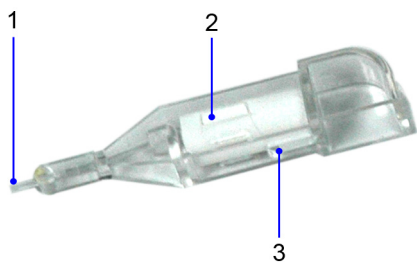

- 1 Glass Capillary
 - 2 Absorbent Pad
 - 3 Latching Mechanism
-

Figure 9 Capillary Holder

Filling the Glass Capillary with Blood from Finger Stick

When the capillary is filled with the sample, analysis must begin within 5 minutes.

1. Hold the capillary holder at an angle.
2. Touch only the tip of the capillary to a small drop of blood on the finger until the capillary fills.

NOTE: 1 μL of blood is required to fill the capillary.

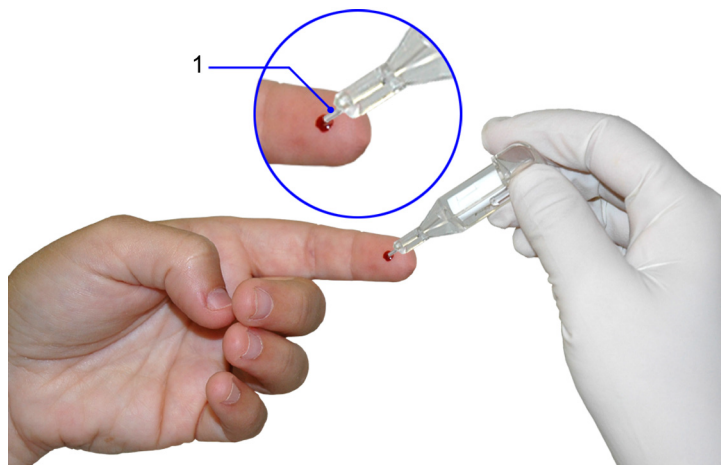

1 Glass Capillary Tip

Figure 10 Filling Capillary Holder with Blood from Finger Stick

Filling Glass Capillary with Blood Obtained by Venipuncture

When the capillary is filled with the sample, analysis must begin within 5 minutes.

1. Mix the sample well (by inversion or use of a tube mixer) to prevent separation of red blood cells and plasma.
2. Remove stopper from blood collection tube in such a way that a small sample of blood remains on the stopper.
3. Hold the capillary holder at an angle.
4. Touch only the tip of the capillary to the blood sample on the stopper.

NOTE: Do not attempt to fill the capillary by touching the glass capillary to blood in a blood collection tube. Attempting to fill the capillary in this manner most often results in blood touching the capillary holder. If blood touches the capillary holder, discard the capillary holder.

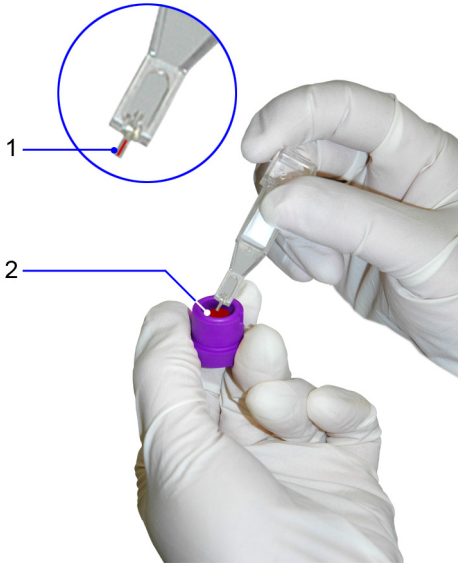

- 1 Glass Capillary Tip
- 2 Blood Sample

Figure 11 Filling Capillary with Blood from Venipuncture

- Using a lint-free tissue, carefully wipe the outside of the glass capillary.

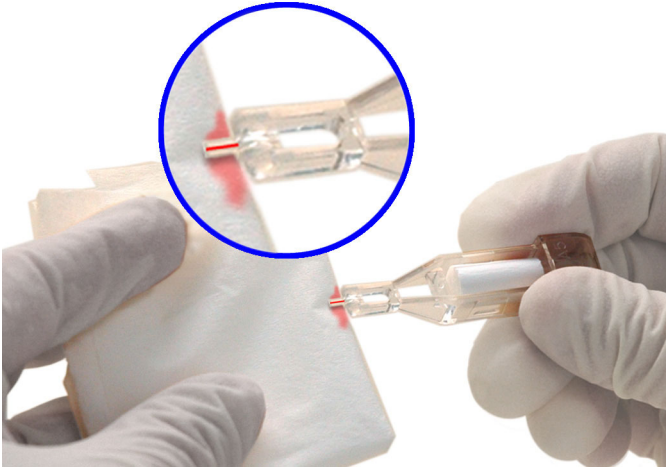

Figure 12 Wiping Outside of the Glass Capillary

NOTE: Do not allow the tissue to touch the open end of the glass capillary. Contact with the open end of the capillary could result in loss of sample (by wicking into the tissue). If sample loss is obvious, discard the capillary holder. Repeat the procedure using a new capillary holder.

- Inspect the glass capillary for the presence of bubbles.
If bubbles are obvious, discard the capillary holder and repeat the procedure using a new capillary holder.

Inserting Capillary Holder into Reagent Cartridge



CAUTION

Avoid harsh insertion of the capillary holder into the cartridge. Do not dislodge the sample from the glass capillary or erroneous results may occur.

After filling the capillary, carefully insert the capillary holder into the reagent cartridge until the holder gently snaps into place.

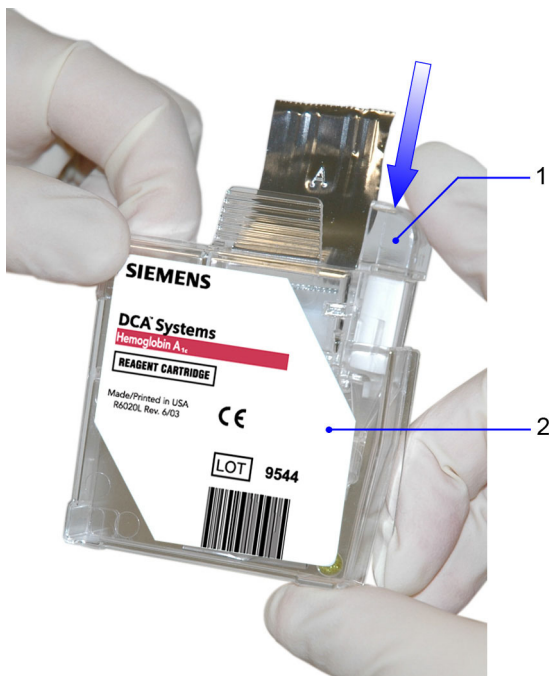

- 1 Glass Capillary
- 2 Reagent Cartridge

Figure 13 Inserting Capillary Holder into a Reagent Cartridge

Scanning the Reagent Cartridge

Before a lot of Reagent Cartridges can be used on the system, the Calibration Card for the lot must be scanned. If a Reagent Cartridge is scanned on the Home screen and there is no Calibration Data for the lot of Reagent Cartridges, you must scan in the Calibration Data. Scanning the Calibration Card enters information about the Reagent Cartridge Lot into the system. This screen has a 10-second time-out. Refer to *Running a Control Test*, page 91 for more information.



CAUTION

If you have stored the reagent cartridge in a refrigerator, bring the reagent cartridge to room temperature before starting a test. Refer to the specific product insert for more information.

1. Locate the dot (on the system) next to the barcode track.
2. Locate the barcode on the reagent cartridge.
3. Hold the reagent cartridge so that the barcode faces to the right.
4. Insert the reagent cartridge (above dot) into the barcode track.

5. Smoothly, slide the reagent cartridge down.

A beep sounds to signal a successful scan.

NOTE: If no beep sounds, repeat procedure. If a beep repeatedly fails to sound, refer to *Troubleshooting*, page 123.

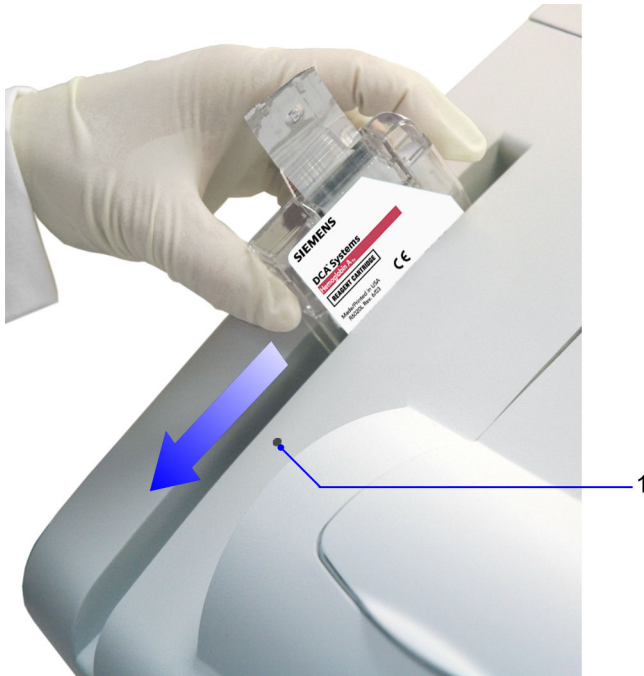

1 Barcode track dot

Figure 14 Scanning the Reagent Cartridge

Inserting the Reagent Cartridge into the System

1. Open the cartridge compartment door.
2. Hold the reagent cartridge so that the barcode faces to the right.
3. Insert the reagent cartridge into the cartridge compartment until a gentle click is heard or felt.

NOTE: The cartridge is designed to fit only one way into the system. Do not force the cartridge into system.



Figure 15 Inserting the Reagent Cartridge into the Cartridge Compartment

4. Using a smooth, slow, continuous motion, pull the flexible pull-tab completely out of the reagent cartridge.
5. Close the door and dispose of the flexible pull-tab.
Five seconds after the door is closed, a beep sounds and the assay begins.

NOTE: If you accidentally close the door before you pull the flexible plastic tab, you have 5 seconds to reopen the door and pull the tab.

Entering Patient Sample Data

The Sample Data screen displays when the system detects that the system door is closed. The appearance of this screen after the 5-second delay, indicates that a test is in progress.

NOTE: You can enter data during the test only if you have configured the system to enable data entry.

You can enter the following sample demographic information using the touchscreen or external barcode reader:

- Sample ID
- Patient ID
- Last Name
- First Name
- Comment 1–8
- Operator ID

Entering Patient Information Using the Touchscreen

1. Select **Sample ID**.
2. Enter the **Sample ID**.
3. Select **Enter**.

The Sample ID displays next to the Sample ID button.

4. Select **Patient ID**.
5. Enter the **Patient ID**.
6. Select **Enter**.

The Patient ID displays next to the Patient ID button.

7. Select **Last Name**.
8. Select **First Name**.
9. Select **Comments 1–8**.
10. Select **Operator ID**.

The Operator ID is pre-populated (and read-only) if the system is in Restricted Plus mode or Fully Restricted mode.

NOTE: If GFR is enabled, you can calculate the GFR.

Rules for Entering Patient Data Using the Barcode Reader

The following rules apply to data entered by the external barcode reader:

- You can enter and display the following characters: A–Z, a–z, 0–9, space, and punctuation characters. The system accepts the following punctuation characters:
! " # \$ & ' () * + , - . / : ; < = > ? @ [\] ^ _ ` { | } ~

NOTE: The percent sign (%) is valid only on Recall Search screens, where it is used as a wildcard character in the search.

- When creating barcodes, use only the characters that are allowed for the corresponding input fields.
- The system accepts data input of user-entered information from user-supplied barcodes read on the external barcode reader for the following Operator Management screen fields for adding or editing:
 - Operator ID
 - Access Code
- A search to recall the samples associated with the data entered by barcode is not case sensitive.
- The system accepts data input of user-entered information from user-supplied barcodes read on the external barcode reader whenever a user is prompted to enter an Access Code.

The barcode symbols, and the labels themselves, must meet certain specifications, detailed below:

Number of Characters: 1–24 data characters. (A maximum of 24 characters can be displayed, stored, printed, and transmitted by the DCA Vantage system.)

The Interleaved 2 of 5 (I2of5) symbology requires an even number of characters. If a scanned barcode has an odd number of characters, the symbology adds a leading zero, up to the maximum of 24 characters. For example, 1 becomes 01.

Narrow Bar Width: 0.15–0.51 mm (0.006–0.02 inches). It is better to be closer to the upper limit (0.51 mm/0.02 inches), as long as the entire barcode can be contained within the maximum length.

This measurement affects both the symbol length and how far away from the label you can hold the handheld reader. If the narrow bar width is at the minimum, the symbol length can be no greater than 90 mm (3.5 inches), including quiet zones, and the reader can be held no more than 75 mm (3 inches) away.

Narrow to Wide Ratio: Must be within the specifications for the format being used. This is generally 2.0–3.0.

Symbol Length: Variable. See *Narrow Bar Width* for more information.

Quiet Zone: Minimum of 10 times the narrow bar width at each end of the symbol.

Symbol Height: Minimum of 10 mm (0.40 inches).

Total Size of Label: May be greater than the size of the symbol to allow for printing of human readable information. Printing of the specimen ID number in alphanumeric digits is strongly recommended.

Symbol grade: Minimum grade of “C” as defined by ANSI X3.182-1990 (available from American National Standards Institute, 1430 Broadway, New York, NY 10018).

Wavelength of Light: 630 nm (visible red LED).

Entering Patient Data Using the Barcode Reader

When the Sample Data screen displays, you can use the external barcode reader to scan the patient barcodes in each selection to add the patient data (First Name, Last Name, Patient ID, Sample ID, Operator ID, Access code (if required), and Comments).

1. Select **Sample ID**.
2. Scan the Sample ID barcode.
The Sample ID displays next to the Sample ID button when the scan completes.
3. Select **Patient ID**.
4. Scan the Patient ID barcode.
The Patient ID displays next to the Patient ID button when the scan completes.
5. Continue selecting the Sample Data fields (First Name, Last Name, Operator ID, Comments), and scanning the barcodes to enter the information.
NOTE: The Operator ID is pre-populated (and read-only) if the system is in Restricted Plus mode or Fully Restricted mode.

Cancelling a test

You can cancel a test anytime. While a test is running, a display shows the time remaining and a Cancel button. If a test in progress is cancelled, you must discard the sample.

To cancel a test, select **Cancel**.

Displaying, Printing, and Sending Results

You can print patient test results from the Results screen, the Recall screen, or the Edit User Data screen.

Whenever one or more printers is enabled and set to Autoprint, the system prints the patient test results as soon as the data entry process and the sample analysis is complete.

The Result screen displays when the system finishes analyzing the sample. This screen displays result values and demographics for each test. You can edit the sample demographics and comments at the Sample Data screen, and you can print the result.

If you have enabled automatic printing, the test result prints automatically as soon as the test result displays. If you edit the data, you must manually select **Print** if you want a printed record of the change.

To print manually, select **Print**. If the print button is not enabled, then the printer is disabled in Setup, or there is no paper.

If you select the **Full Report** option, all of the information that displays on the screen prints in the report.

If you select the **Short Report** option, a subset of the displayed information prints in the report.

If you have enabled Auto Send, the system sends the test results automatically to the LIS as soon as the test has completed. If you enter or modify the patient demographic data, the system automatically saves the changes and sends the test results to the LIS when you select **Next** on the Edit User Data screen.

HbA_{1c} Patient Test Results

The system displays the following information for each patient HbA_{1c} test.

You have to enable some of the data entries in System Settings. For more information, see *Setting Patient Data Entry*, page 153.

Result	Description
System Serial Number	The serial number of the DCA Vantage system.
Test Name	The type of test, either Microalbumin/Creatinine test or HbA _{1c} test.
Sample Sequence Number	The sample sequence number.
Transmission Status	The transmission status of the record.
Cartridge Lot Number	The lot number of the cartridge.
Test Cartridge Scan Date and Time	The date and time the test cartridge was scanned.
Sample ID	The sample ID, if you entered one into the system.
Patient ID	The patient ID, if you entered one into the system.
Patient Last Name	The last name of the patient, if you entered one into the system.
Patient First Name	The first name of the patient, if you entered one into the system.

Result	Description
Operator ID	The Operator ID, if you entered one into the system.
Comment 1–8	Any comments you entered regarding the patient.
Glomerular Filtration Rate (GFR) and input data items	The GFR calculated measurement based upon data input. The GFR is displayed if calculated. Refer to <i>Configuring GFR for a Patient</i> , page 82.
HbA _{1c} %	The percentage of HbA _{1c} .
Primary and Secondary Reporting Units)	The primary and secondary (if selected) HbA _{1c} Reporting Units names display.
User correction slope and offset	The user correction slope and offset if one is applied to HbA _{1c} .

For information about printing reports, see *Printed Reports*, page 185.

Result Details

The HbA_{1c} Test displays the Hemoglobin A_{1c} in percent or the IFCC standard units of mmol/mol.

Table 4 HbA1c Reporting Range (%) (Only for NGSP Reporting Units)

Sample Type	Reporting Range
Patient	2.5–14.0%
Control	2.5–16.0%

The test is linear throughout the range.

A result preceded by a less than (<) sign in the display indicates that the concentration is below the lower limit of the test, that is < 2.5%.

A result preceded by a greater than (>) sign in the display indicates that the concentration is above the upper limit of the test, that is > 14.0% for patient samples and > 16.0% for control samples.

If you set the Reference Range for the HbA_{1c} Patient Test at 3.5% to 12%, a value of 3.2% is displayed as "3.2% -" showing that it is within the Reporting Range but below the Reference Range. Similarly a value of 12.5% is displayed as "12.5% +" showing that it is within the Reporting Range but above the Reference Range. A value of 5.2% is displayed as "5.2%" because it is within both the Reference and Reporting Ranges.

Result Details Using Single or Dual Reporting Units

You can display and print the HbA_{1c} results in single or dual reporting units. For example, the system can report test results in IFCC standard or NGSP units, or both.

A supervisor (that is, a Level 1 operator) can designate the required primary and optional secondary HbA_{1c} reporting units for printing data. Based on this setting, the system displays the appropriate primary, and optional secondary HbA_{1c} reporting units. See *Designating the Primary and Secondary HbA_{1c} Reporting Units*, page 155.

NOTE: You can print, enter, or edit the sample data while the results are displayed.

Removing the Reagent Cartridge



WARNING

Avoid contact with cartridge holder heater plates when removing cartridges.

When the tests are complete, remove the reagent cartridge from the system.

1. Open the cartridge compartment door.
2. Locate the button on the right side of the cartridge compartment.
3. Push and hold it down with your right hand.
4. With your left hand, gently push the tab on the cartridge to the right.
This action releases (unlocks) the cartridge.

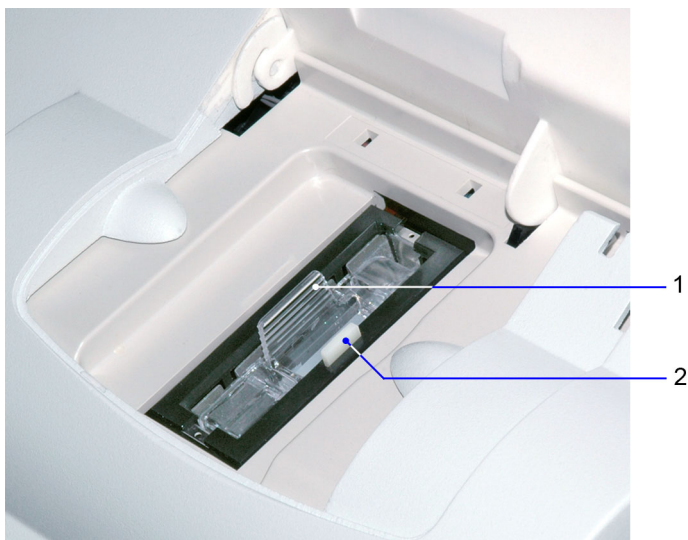

- 1 Reagent Cartridge
- 2 Release Button

Figure 16 Removing the Reagent Cartridge

- 5. Pull the reagent cartridge out of the compartment.



CAUTION

When handling the reagent cartridge, do not force the removal of the cartridge. This can cause physical injury to you and damage to the system.

- 6. Close the system door.
- 7. Discard the cartridge in a proper container, according to your standard laboratory procedures.

Microalbumin/Creatinine Test

The following sections explain the test sequence for a Microalbumin/Creatinine test.

Preparing Patient Samples and Controls for the Microalbumin/Creatinine Test

Materials Required:

- DCA Systems Microalbumin/Creatinine Reagent Kit (For use with the DCA Vantage system)
- patient sample
- Creatinine Control Kit or other control
- lint-free tissue

For information on preparing controls, refer to *Quality Control*, page 89.

For information on calibrating, refer to *Calibrating for Microalbumin/Creatinine*, page 87.

Performing a DCA Microalbumin/Creatinine Test



BIOHAZARD

Wear personal protective equipment, including safety glasses and gloves. Use universal precautions. Refer to *Safety Information*, page 169 for recommended precautions when working with biohazardous materials.

You can save unused capillary holders and use them with any lot of DCA Systems Microalbumin/Creatinine reagent cartridges.

1. Open and inspect the contents of the Reagent Cartridge foil package. Refer to *Opening and Inspecting the Reagent Foil Package*, page 45.
2. Remove a capillary holder and a plunger from the plastic bag.

3. Inspect the capillary holder for the presence of the parts. Refer to Figure 17.

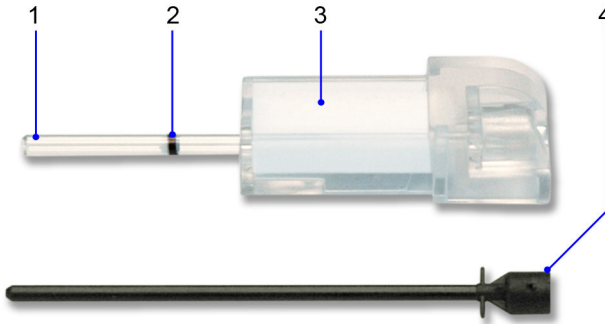

- 1 Glass Capillary
- 2 Starch Plug
- 3 Absorbent Material
- 4 Plunger

Figure 17 Capillary Holder

If the capillary holder is missing any of the above parts or parts are damaged, discard the capillary holder; also discard it if the starch plug is at the bottom of the capillary tube.

Filling the Capillary Tube with Urine from a Container with a Large Sample Volume

If the urine sample was refrigerated, allow the sample to come to room temperature before running any tests. Mix the urine specimen thoroughly before use.

1. Immerse the tip of the capillary tube in the thoroughly mixed urine sample.
2. Allow enough time for the urine sample to flow into the capillary tube and come in contact with the starch plug, approximately 5 seconds.

Wetting the starch plug seals the capillary tube and keeps the urine within the tube.

3. Remove the capillary tube from the urine sample.

If the urine flows back down the tube, reimmerse the capillary tube in the urine sample again, and allow enough time to ensure that the starch plug becomes saturated.

4. Using a lint-free tissue, carefully wipe the outside the capillary tube.



1 Starch Plug

Figure 18 Filling the Capillary with Urine

Filling the Capillary Tube with Urine from a Container with a Small Sample Volume

If the urine sample was refrigerated, allow the sample to come to room temperature before running any tests. Mix the urine specimen thoroughly before use.

1. Immerse the tip of the capillary tube in the thoroughly mixed urine sample.

NOTE: 40 μ L is required to fill the capillary.

2. Tilt the sample container and the capillary holder to a more horizontal position to increase the rate of flow into the capillary.

Take care not to spill the urine sample.

3. Allow enough time for the urine specimen to flow into the capillary tube and come in contact with the starch plug.

Wetting the starch plug seals the capillary tube and keeps the urine within the tube.

4. Remove the capillary tube from the urine specimen.

If the urine flows back down the tube, re-immerses the capillary tube in the urine specimen again, and allow enough time to ensure that the starch plug becomes saturated.

5. Using a lint-free tissue, carefully wipe the outside of the glass capillary tube.



Figure 19 Wiping the Outside of the Glass Capillary Tube

NOTE: Do not allow the tissue to touch the open end of the glass capillary. Contact with the open end of the capillary tube could result in loss of sample (by wicking into the tissue). If sample loss is obvious, discard the capillary holder; then repeat the procedure using a new capillary holder.

6. Inspect the glass capillary tube for the presence of bubbles.
If bubbles are obvious, discard the capillary holder; then repeat the procedure using a new capillary holder.

Inserting the Capillary Holder into Reagent Cartridge

1. Carefully insert the capillary holder into the reagent cartridge until the holder gently snaps into place.



CAUTION

Avoid harsh insertion of the capillary holder. Do not dislodge the sample from the glass capillary or erroneous results may occur.

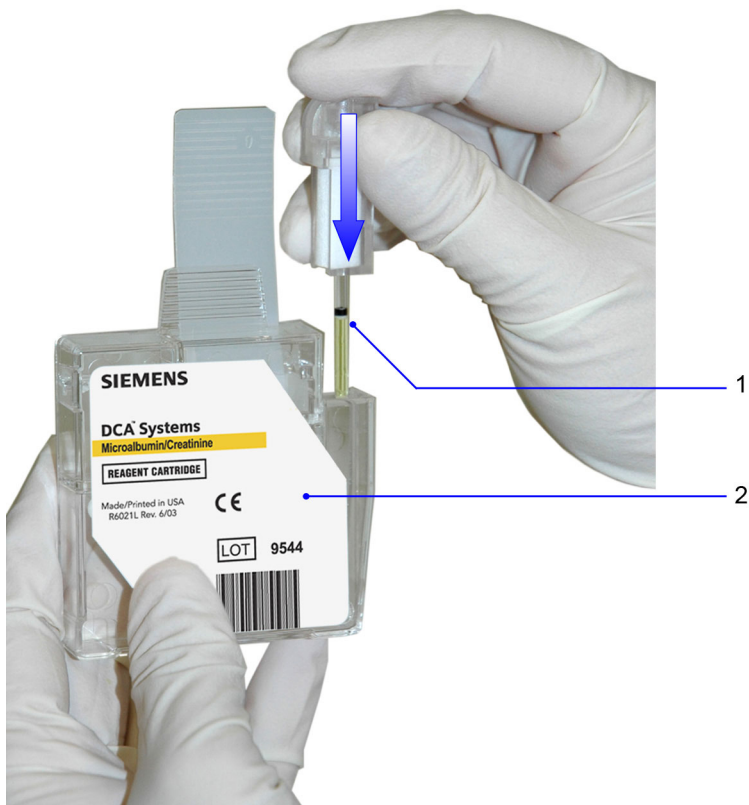

- 1 Glass Capillary
- 2 Reagent Cartridge

Figure 20 Inserting the Capillary Holder into Reagent Cartridge

Scanning the Reagent Cartridge

1. Locate the dot (on the system) next to the barcode track.
2. Locate the barcode on the reagent cartridge.
3. Hold the reagent cartridge so that the barcode faces to the right.
4. Insert the reagent cartridge (above dot) into the barcode track.
5. Smoothly, slide the reagent cartridge down.

NOTE: After a 1 second pause, a beep sounds to signal a successful scan. If no beep sounds, repeat the procedure. If a beep repeatedly fails to sound, refer to *Troubleshooting*, page 123.

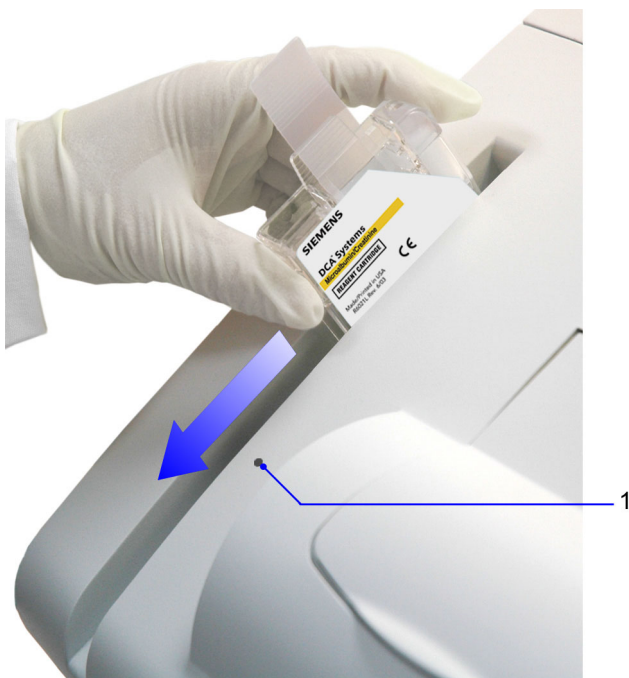

1 Barcode Track Dot

Figure 21 Scanning the Reagent Cartridge

Inserting the Reagent Cartridge into System

1. Open the reagent cartridge compartment door.
2. Hold the reagent cartridge so that the barcode faces to the right.
3. Insert the reagent cartridge into the cartridge compartment until you hear a gentle snap.

NOTE: The cartridge is designed to fit only one way into the system. Do not force the cartridge into the system.



Figure 22 Inserting Reagent Cartridge into System

4. Insert the plunger into the hole at the top of capillary holder.
5. Press the plunger into the capillary holder.
The plunger locks into the capillary holder.

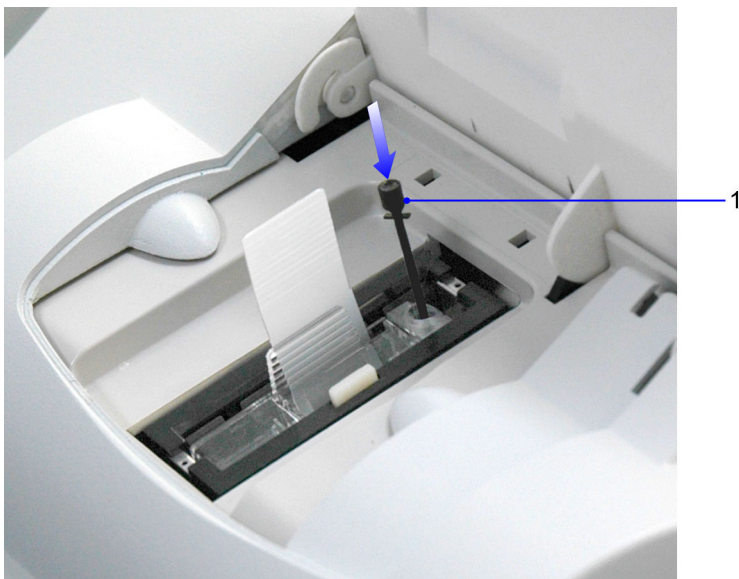

1 Plunger

Figure 23 Inserting Plunger into the Capillary

6. Using a smooth, slow, continuous motion, pull the flexible pull-tab completely out of the reagent cartridge.
7. Close door and dispose of the flexible pull-tab.
Five seconds after the door is closed, a beep sounds and the assay begins.

NOTE: If you accidentally close the door before you pull the flexible tab, you have 5 seconds to reopen the door and pull the tab. The test resumes once the door is closed.

Cancelling a test

You can cancel a test anytime. While a test is running, a display shows the time remaining and a Cancel button. If a test in progress is cancelled, you must discard the sample.

To cancel a test, select **Cancel**.

Results of a Microalbumin/Creatinine Test

The system displays the following information for each patient Microalbumin/Creatinine test.

NOTE: You have to enable some of the features in System Settings for the data to display.

Result	Description
System Serial Number	The serial number of the DCA Vantage system.
Test Name	The type of test, either Microalbumin/Creatinine test or HbA _{1c} test.
Sample Sequence Number	The sample sequence number.
Transmission Status	The transmission status of the record.
Sample ID	The sample ID, if you entered one into the system.
Cartridge Lot Number	The lot number of the cartridge.
Test Cartridge Scan Date and Time	The date and time the test cartridge was scanned.
Patient ID	The patient ID, if you entered one into the system.
Patient Last Name	The last name of the patient, if you entered one into the system.
Patient First Name	The first name of the patient, if you entered one into the system.
Operator ID	The Operator ID, if you entered one into the system.
Comment 1–8	Any comments you entered regarding the patient.
Glomerular Filtration Rate (GFR) and input data items	The GFR calculated measurement based upon data input. The GFR is displayed if calculated. Refer to <i>Configuring GFR for a Patient</i> , page 82.
Albumin concentration results	The albumin concentration results display in units of mg/L.
Creatinine concentration results	The creatinine concentration results display in mg/dL or mmol/L.

Result	Description
Albumin/Creatinine ratio	The Albumin/Creatinine ratio results display in mg/g units if Creatinine units are mg/dL, or in mg/mmol if creatinine units are mmol/L.
Albumin user correction slope and offset	The Albumin user correction slope and offset display.
Creatinine user correction slope and offset	The Creatinine user correction slope and offset display.

Result Details

The Microalbumin/Creatinine test displays 3 values:

- Albumin concentration
- Creatinine concentration
- Albumin/Creatinine ratio

Both the albumin and creatinine tests are linear throughout their ranges.

NOTE: If there is an asterisk next to the result percent, this indicates that the results were user corrected.

The following table displays the reporting range for each test.

Test	Reporting Range
Albumin	5–300 mg/L
Creatinine	15–500 mg/dL (1.3–44.2 mmol/L)
Albumin/Creatinine ratio	1–2000 mg/g (0.11 to 226 mg/mmol)

NOTE: If creatinine units are mg/dL, then the Albumin/Creatinine (A/C) ratio is reported as mg/g. If the creatinine units are mmol/L, then the Albumin/Creatinine (A/C) ratio is reported as mg/mmol.

An albumin or creatinine value preceded by a less than sign (<) in the display, indicates that the concentration is below the lower limit of the test, that is < 5 mg/L for albumin or < 15 mg/dL for creatinine.

An albumin or creatinine value preceded by a greater than sign (>) in the display, indicates that the concentration is above the upper reporting limit of the test, that is > 300 mg/L for albumin and > 500 mg/dL for creatinine.

An Albumin/Creatinine ratio preceded by a less than (<) sign or greater than (>) sign or (---) in the display, indicates that either the albumin and/or creatinine value is above or below the Reporting Range. In certain cases, no ratio is reported (---).

Example 1: If the albumin result is > 300 mg/L and the creatinine result is 100 mg/dL (8.84 mmol/L), the ratio is reported as > 300 mg/g (> 33.9 mg/mmol).

Example 2: If the albumin result is 75 mg/L and the creatinine result is < 15 mg/dL (< 1.33 mmol/L), the ratio is reported as > 500 mg/g (> 56.4 mg/mmol).

Example 3: if the albumin result is > 300 mg/L and the creatinine result is > 500 mg/dL (> 44.2 mmol/L), no ratio is reported (---).

Example 4: if the albumin result is < 5 mg/L and the creatinine result is < 15 mg/dL (< 1.33 mmol/L), no ratio is reported (---).

As with HbA_{1c} Patient Tests, you can configure Reference Ranges for Albumin and Creatinine concentrations and the Albumin/Creatinine ratio for Patient Tests. Values above or below the Reference Range limits, but within the Reporting, are followed by the applicable plus (+) or minus (-) sign.

NOTE: You can print, enter, or edit the sample data while the results are displayed.

For information about printing a report of patient microalbumin/creatinine test results, see *Displaying, Printing, and Sending Results*, page 59.

For a summary of the contents of full and short patient reports, see *Patient Test Report Contents*, page 185.

Removing the Reagent Cartridge

When the test is complete, remove the reagent cartridge from the system.



WARNING

Avoid contact with cartridge holder heater plates when removing cartridges.



CAUTION

When handling the reagent cartridge, do not force the removal of the cartridge. This can cause physical injury to you and damage to the system.

1. Open the cartridge compartment door.
2. Locate the button on the right side of the cartridge compartment.
3. Push and hold it down with your right hand.

4. With your left hand, gently push the tab on the cartridge to the right. This action releases (unlocks) cartridge.

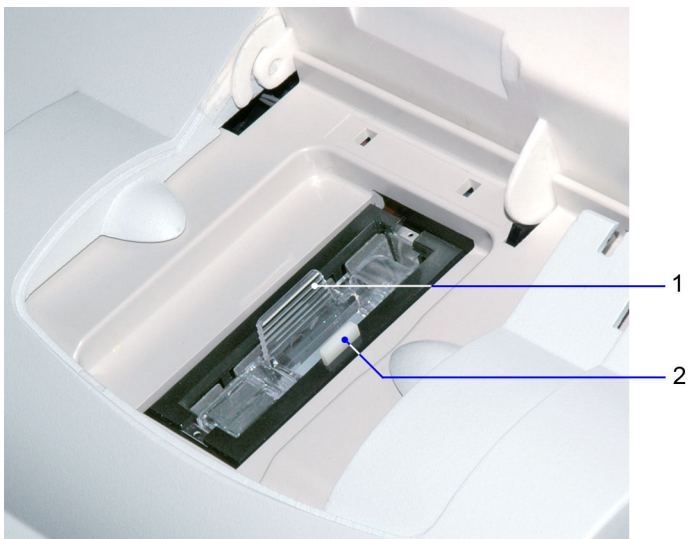

- 1 Reagent Cartridge
- 2 Release Button

Figure 24 Removing the Reagent Cartridge

5. Pull the cartridge out of compartment.
6. Close the system door.
7. Discard the cartridge in a proper container, according to your standard laboratory procedures.

Recalling Patient Data, Control Tests, and Calibration Data

Use the Recall Menu to access patient tests, control tests, and calibration data. You can restrict edit and delete functionality in the Recall menu in System Settings. Refer to *Customizing the System*, page 153.

The Enter Access Code screen displays when you attempt to access the Recall Menu if system access is set to Fully Restricted in System Settings. If System Access is set to Unrestricted, Restricted, or Restricted Plus, this screen does not display.

NOTE: The default security setting is set to **Off** so that an access code is not required.

Recalling Patient Tests

Use the Patient Tests menu to access data for HbA_{1c} or Microalbumin/Creatinine test, or to export data to an external storage device via the USB port.

NOTE: If there is an asterisk next to the result percent, this indicates that the results were user corrected.

Viewing the Last 10 Patient Tests

Use the View Last 10 patient test screens for HbA_{1c} and Microalbumin/Creatinine to view the last 10 test results performed at the system. The sort order starts with the most recent test performed.

1. From the Home screen, select **Recall**.
2. From the Recall menu, select **Patient Tests**.
3. Select one of the following types of patient tests:
 - To view HbA_{1c} patient test results, select **HbA1c**.
 - To view microalbumin/creatinine patient test results, select **Microalbumin/Creatinine**.
4. Select **View Last 10**.
The last 10 patient tests display.

You can delete patient tests at this screen by performing the following steps:

1. While viewing the patient tests, select a test.
The patient test is highlighted.
2. Select **Delete**.
A message displays verifying that you want to delete the patient test result.
3. Select **OK**.
4. Delete all of the last 10 patient tests, if needed:
 - a. Select **Delete All**.
A message displays verifying that you want to delete all of the last 10 patient tests.
 - b. Select **OK**.

Searching for a Patient ID or Name

Use the Patient ID/Name screen to search by either patient ID number or name.

NOTE: To use the search feature, this option is configured in System Settings, Additional Settings.

1. From the Home screen, select **Recall**.
2. From the Recall menu, select **Patient Tests**.

3. Search for one of the following:
 - To search for patient ID or name for an HbA_{1c} patient test result, select **HbA1c**.
 - To search for patient ID or name for a microalbumin/creatinine patient test result, select **Microalbumin/Creatinine**.
4. Select **Patient ID/Name**.
5. Enter the patient ID or patient name that you want to find with the keypad or external barcode reader.
Use the percent (%) character as the wildcard for searching.
6. Select **Next**.
The search results display.
7. Delete a patient test, if needed:
 - a. Select the test.
 - b. Select **Delete**.
A message displays verifying that you want to delete the patient test result.
 - c. Select **OK**.
8. Delete all of the patient tests, if needed:
 - a. Select **Delete All**.
A message displays verifying that you want to delete all the patient tests.
NOTE: Only the tests that are recalled in the search are deleted.
 - b. Select **OK**.

Searching for a Specific Comment

Use the Comment 1 screen to search for a specific comment.

1. At the Home screen, select **Recall**.
2. From the Recall menu, select **Patient Tests**.
3. Search for one of the following:
 - To search for a specific comment for an HbA_{1c} patient test result, select **HbA1c**.
 - To search for a specific comment for a microalbumin/creatinine patient test result, select **Microalbumin/Creatinine**.
4. Select **Comment 1**.
5. Enter the comment using the keypad or external barcode reader.
6. Select **Next**.
The search results display.

Searching within a Specific Date Range

Use the Start Date and End Date screens to set the start and end dates when you want to search by a specific date range.

1. At the Home screen, select **Recall**.
2. From the Recall menu, select **Patient Tests**.
3. Search for one of the following:
 - To search within a specific date range for an HbA_{1c} patient test result, select **HbA1c**.
 - To search within a specific date range for a microalbumin/creatinine patient test result, select **Microalbumin/Creatinine**.
4. Select **Date Range**.
The Start Date screen displays.
5. Use the up and down arrows to select the Month, Day, and Year.
6. Select **Next**.
The End Date screen displays.
7. Use the up and down arrows to select the Month, Day, and Year.
8. Select **Next**.
The search results display.

To delete a patient test from the date range results:

1. Highlight the test.
2. Select **Delete**.
A message displays verifying that you want to delete the patient tests.
3. Select **OK**.
4. To delete all the patient tests select **Delete All**.
A message displays verifying that you want to delete all the patient tests.
NOTE: Only the tests that are recalled in the search are deleted.
5. Select **OK**.

Searching by Result Range

Use the Set Lower Limit screen to set the lower HbA_{1c} value when you search by result range.

1. At the Home screen, select **Recall**.
2. From the Recall menu, select **Patient Tests**.
3. Select **HbA1c**.
The HbA_{1c} Patient Test screen displays.

4. Select **Result Range**.

The Lower Limit screen displays.

5. Use the up and down arrows to set a HbA_{1c} value.

NOTE: For NGSP only, the lower limit cannot be lower than 2.0%.

6. Select **Next**.

The search results display.

Viewing the HbA_{1c} Results in Graph Format

You can view the HbA_{1c} test results in a graph format. You can search by patient ID and then narrow the search by using a date range.

NOTE: Recalled results and trend graphs adapt to your configured Reporting Units, Patient Reference Range, and User Corrections.

1. At the Home screen, select **Recall**.

2. From the Recall menu, select **Patient Tests**.

3. Select **HbA1c**.

The HbA_{1c} Patient test List screen displays.

4. Select **Graph**.

5. Use the keypad or external barcode reader to enter a Patient ID.

6. Select **Next**.

All HbA_{1c} results that match the patient ID are graphed.

7. To change the graph date range, select **Change**.

8. To print the graph to an external printer, select **Print**.

NOTE: The internal printer does not support printing graphs.

Viewing Patient Test Results

Use the Patient Test Result screen to view information about a specific patient.

1. At the Home screen, select **Recall**.

2. From the Recall menu, select **Patient Tests**.

3. Select one of the following:

- To view patient results for an HbA_{1c} patient test result, select **HbA1c**.
- To view patient results for an microalbumin/creatinine patient test result, select **Microalbumin/Creatinine**.

4. Select **View Last 10**.

NOTE: You can view patient results from any search finding.

5. At the Last 10 HbA1c or A/C patient tests screen, select the patient and select **View**.

The Patient Test Result screen displays.

6. To print a copy of the patient results, select **Print**.
7. To send the data to an LIS or computer, select **Send**.

NOTE: When recalling any type of results, Auto Send does not automatically send the data to the LIS. You must select **Send** to transmit the record.

8. To edit the patient test results, select **Edit**.

Editing Patient Data

You can recall patient data to enter new data or edit previously entered data.

1. At the Home screen, select **Recall**.
2. Select **Patient Tests**.
3. Select the test and the patient record.
4. Select **Edit**.

The Edit button is available only if at least one patient demographic setting option is enabled (including GFR).

NOTE: If you are using the I2of5 barcode, scan the provided I2of5 barcode before entering or editing any data.

5. To enter new patient data in the recall mode, select the desired patient data button.
6. Edit the data using the keypad or scan data using the barcode.
The selected patient data field populates.
7. To edit previously entered patient data, select the desired patient data button.
8. To erase previously entered data, select **CE**.
9. Scan the desired barcode information, then select **Enter**.

Selecting a Printer

If both the onboard and external printer are enabled, use the Printer Selection screen to select the printer.

NOTE: This screen displays only when both printers are configured and ready to print.

1. At the Patient Test Result screen, select **Print**.
The Printer Selection screen displays.

2. Select one of the following printer options:
 - Onboard Printer
 - External Printer
3. To print the patient test results, select **Print**.
The patient test results print.

Configuring GFR for a Patient

The Glomerular Filtration Rate (GFR) describes the flow rate of filtered fluid through the kidney. While running a patient test, the Sample Data Entry screen displays. Use the GFR screen from the Sample Data Entry screen to enter patient data including age, race, gender, and plasma creatine to calculate the GFR for the patient.

1. At the Sample Data Entry screen, select **GFR**.
2. Enter the following data, which calculates the GFR for the patient:
 - a. Select the 2-digit age value for the patient.
The patient age range is between 18 and 70.
 - b. Select **Next**.
 - c. Select the Gender of the patient.
 - d. Select **Next**.
 - e. Select the Race of the patient.
 - f. Select **Next**.
 - g. Select the Plasma Creatinine value.
 - h. Select **Next**.
The GFR Calculation results screen displays the GFR value calculated from the information entered at the GFR calculation screen.

Reports

Patient Test Reports

Patient Test Reports contain the results of HbA_{1c} and Microalbumin/Creatinine tests that you generate during analysis and display at the results screen. You can generate printed reports at analysis time and when print requests are issued at Data Recall. You can also generate a printed report when you perform a Demonstrated Patient Test.

Report Components

You can specify whether to print a long or a short report of the patient test results. For a summary of the contents of patient test printed reports, see *Printed Reports*, page 185. Regardless of the printed report type setting, the system transmits the long-form report.

Patient Trend Graph Report

The printed Patient Trend Graph Report prints from the Data Recall menu to an external printer. To print a graph, you must have an external printer connected to the DCA Vantage system. For a description of the contents of this report, see *Patient Trend Graph Report Contents*, page 187.

Control Test Report

The Control Test Report prints the results for Control Tests generated during analysis, and displays at the Results screen. For a description of the contents of this report, see *Control Test Report*, page 188.

NOTE: The patient printed test report has no effect on the Control Test Report.

Calibration Data Report

The Calibration Data Report prints the results generated when the HbA_{1c} and Microalbumin/Creatinine cards are scanned into the system. The report prints the lot number, date and time that the calibration cards were scanned. The printed reports for a single cartridge scan are generated when you select print when you scan. Calibration Data Reports for all the calibration data stored on the system print when a request is issued at Data Recall.

NOTE: Select **Print** after scanning the calibration card to print the calibration data report.

Viewing and Printing System Settings Reports

The View System Settings option lets you display and print a partial list of the configuration settings for the system. The printed partial System Settings Report contains the same subset of the system settings that appears on the View System Settings screen.

From the Additional Settings screen, you can print a full System Settings Report by selecting **Print** at the bottom of the screen. The full System Settings report contains all of the configuration settings for the system.

For a list of the contents of the full and short System Settings Report, see *System Settings Report*, page 190.

4 Calibration

Overview

The DCA Vantage system is calibrated by the manufacturer and every time the calibration card is scanned. The instrument automatically self-adjusts during first-time power-up and during each assay.

Values for reagent calibration parameters are encoded on the calibration card provided with each of the reagent cartridges. Scan the calibration barcode before using the reagent cartridges. The DCA Vantage system stores 16 distinct calibrations for the DCA Vantage Hemoglobin A_{1c} and Microalbumin/Creatinine Assay. Each calibration is for a different lot. Scan the lot number and test name before you analyze the sample reagent cartridge barcode. This allows access to the appropriate calibration parameter values and calibration curve for the particular lot of reagent in use.

NOTE: If you do not scan the calibration curve into the system for the particular lot number of cartridges that are in use, the system software prompts you to scan the calibration card.

Calibrating for Hemoglobin A_{1c}

You must scan the calibration card for a lot of reagent cartridges before you can use the lot on the DCA Vantage system. Scanning the calibration card enters the information on the DCA Vantage system.

1. Locate the dot on the system next to the barcode track.
2. Locate the barcode on the calibration card.
3. Hold the card so that the barcode faces to the right.
4. Insert the Calibration card into the top of the barcode track.

5. Hold the Calibration card gently against the right side of the track and smoothly slide the card down.

A beep sounds to signal a successful scan.

NOTE: If no beep sounds, repeat the scanning procedure. If you repeatedly fail to hear a beep, refer to *Troubleshooting*, page 123.

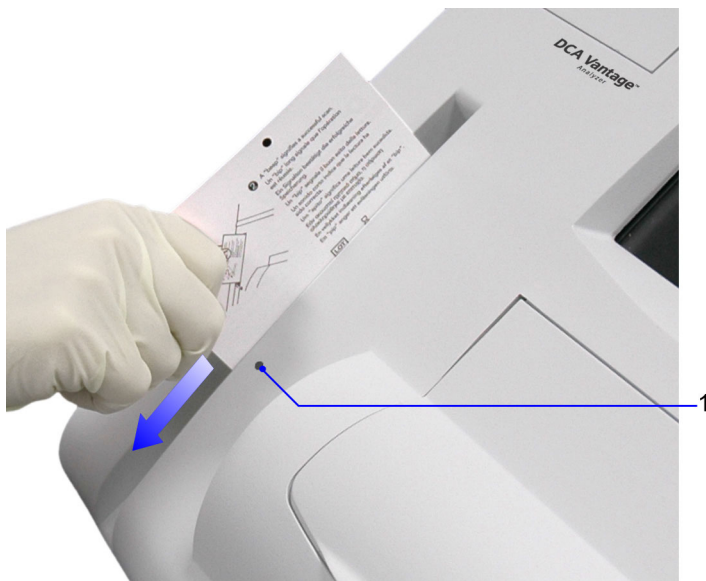

- 1 Barcode track dot

Figure 25 Scanning Hemoglobin A_{1c} calibration card

6. To return to the Home screen, select **OK**.

Calibrating for Microalbumin/Creatinine

The calibration card for the Microalbumin/Creatinine reagent cartridges has data on 2 sides. You must scan both sides of the calibration card for the lot of reagent cartridges before you can use the reagent cartridges on the DCA Vantage system.

1. Locate the dot on next to the barcode track.
2. Locate the barcode on one side of the Calibration card.
3. Hold the card so that the barcode faces to the right.
4. Insert the calibration card into the top of the barcode track.



Figure 26 Scanning the Microalbumin/Creatinine calibration card

5. Hold the calibration card gently against the right side of the track and smoothly slide the card down.
A beep sounds to signal a successful scan.
If no beep sounds, repeat the scanning procedure. If you repeatedly fail to hear a beep, refer to *Troubleshooting*, page 123.
6. Locate the barcode on the second side of the calibration card.
7. Repeat steps 3–5.
8. To return to the Home screen, select **OK**.

Calibration Data

Use the Calibration Data screen to access calibration data including scan date and time, and lot number for DCA HbA_{1c} or Microalbumin/Creatinine.

Viewing Calibration Data Display

1. At the Home screen, select **Recall**.
2. At the Recall menu, select **Calibration Data**.
3. Select one of the following options:
 - a. **HbA_{1c}**
The HbA_{1c} calibration data displays.
 - b. **Microalbumin/Creatinine**
The Microalbumin/Creatinine calibration data displays.
4. Highlight the calibration data that you want to display, and select **View**.
5. To print the calibration data, select **Print**.
6. To return to the Recall menu, select **Recall**.

5 Quality Control

Run controls according to your laboratory's accrediting agency. Quality Control (QC) testing ensures that the reagent cartridges are reacting and being read correctly. Quality control testing also detect errors resulting from user techniques. Refer to your laboratory quality assurance program to ensure quality throughout the entire testing process. Follow the manufacturer's storage and handling instructions for quality control material. Improper storage and handling of control materials can cause erroneous results. Refer to the control material package insert for proper handling instructions.

Run controls under the following conditions:

- at regular intervals determined by the laboratory procedures
- when using a new shipment of reagents
- when using a new lot number of reagent
- each time a calibration card is scanned
- whenever test results are in doubt
- when training new operators

All control results must be within the acceptable range before any patient sample is tested and the results are reported. If a control result is out of range, troubleshoot the system, correct any problems identified, and run the controls again. When control results are within range, you can test and report on patient samples.

For information about ordering control kits, refer to Appendix C, *Orderable Supplies*.

Collecting Control Specimens

Use the following procedure to collect control specimens:

NOTE: Prepare the controls according to the manufacturer's instructions.

1. Remove and unwrap the capillary holder from the Reagent Kit.
2. Mix the sample well by inversion or using a tube mixer.
3. Open the control bottle.

NOTE: Avoid introducing air bubbles into the sample.

4. While applying pressure to the bulb of the dropper (found in the control kit), insert the tip of the dropper into the control solution.
5. Release the pressure on the bulb to aspirate a small amount of control solution.
6. Fill the glass capillary tube by touching it to the tip of the dropper and fill the tube.

NOTE: Touch only the tip of the capillary tube to the control material. If an air bubble is present in the filled tube, discard the capillary holder and fill a new one.



CAUTION

Prevent the control material from coming in contact with the plastic part of the capillary holder. If control material comes in contact with the capillary holder, discard the capillary holder.

7. Squeeze any excess control material out of the dropper into the control bottle.
8. Close the control bottle.
9. Wipe any control solution off the sides of the glass capillary tube using a lint-free tissue.



CAUTION

Do not touch the tissue to the open end of the tube. Contact with the open end could result in a loss of sample.

10. Inspect the capillary holder for the presence of any bubbles.

NOTE: If bubbles are obvious, discard the capillary and repeat the collecting procedure.

Inserting Capillary Holder into the Reagent Cartridge

1. Place the capillary holder in the correct position to insert it into the reagent cartridge.
2. Insert the capillary holder into the reagent cartridge until the holder gently snaps into place.



CAUTION

Avoid harsh insertion of capillary holder. Do not dislodge the sample in the glass capillary because erroneous results may occur.

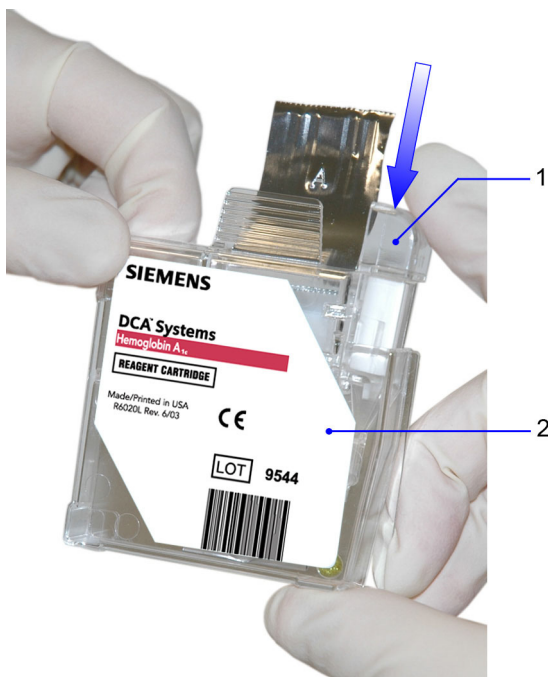

- 1 Capillary holder
- 2 Reagent cartridge

Figure 27 Inserting Capillary Holder into Reagent Cartridge

Running a Control Test

1. Ensure you are at the Home screen.
You must start the control test from the Home screen; otherwise the system does not recognize that a QC test is being run. The system will not save data to memory or prompt that a QC test due (if reminder is set).
2. Locate the control card.
NOTE: One side of the control card is for a normal control and the other side is for an abnormal control.
3. Locate the dot on the system next to the barcode track.
4. Locate the barcode on the Control card.
5. Hold the card so that the barcode faces to the right.
6. Insert the Control card into the top of the barcode track.
7. Hold the Control card gently against the right side of the track and smoothly slide the card down.



- 1 Barcode track dot

Figure 28 Scanning the HbA_{1c} Control Card

A beep sounds to signal a successful scan.

NOTE: If no beep sounds, repeat the scanning procedure. If you repeatedly fail to hear a beep, refer to *Troubleshooting*, page 123.

To scan the reagent cartridge, refer to *Scanning the Reagent Cartridge*, page 54.

To insert the reagent cartridge, refer to *Inserting the Reagent Cartridge into the System*, page 56.



1 Barcode track dot

Figure 29 Scanning the Microalbumin/Creatinine Control Card

Quality Control Errors

If the control results fall outside the values stated in the package insert, the following sources of error may have occurred:

Possible Cause	Corrective Action
Deterioration of the reagent cartridge test areas due to exposure to light, ambient moisture, or heat.	Use a new reagent cartridge to repeat the quality control procedure. Use a fresh box of reagent cartridges, or a new lot. If the new reagent cartridge fails to give results within the expected values, proceed to the next possible cause.
Deterioration of the control solution.	Use a fresh control solution to repeat the quality control procedure.

Setting a Required QC Reminder or Displaying a QC Reminder for New Reagent Lots

The DCA Vantage system can display a reminder message when a QC test is due. You can set the QC test reminder message to display only or display and require a QC test for selected control tests each time a patient test is run.

If you set the system to require a QC, you must run and pass the QC test before you can continue with patient tests.

Setting a QC Reminder

1. At the Home screen, select **Menu**.
2. Select **System Settings**.
3. Select **Additional Settings**.
4. Select **Control Tests**.
5. Select **New Lot Reminders**.

At the New Lots Reminders screen, checkboxes labeled Enabled and Required display for each of the following control tests:

- HbA_{1c} Normal
 - HbA_{1c} Abnormal
 - A/C Low
 - A/C High
6. To activate a QC reminder for the selected reagent test, select the Enabled checkbox.
Do not check the Required checkbox.

Repeat step 6 for any additional tests, as needed.

7. Select **Save**.
8. The next time you scan a cartridge to begin a patient test, the following occurs:
 - If you activated a reminder, the system checks to see if a QC test is needed. If so, a reminder message displays prompting you to perform a QC test.

New Lot Reminder

When the new lot reminder feature is set to required, you must perform QC before you can use reagent cartridges from that new lot. You may still use a reagent cartridge from an existing lot to run patient tests.

When the new lot reminder feature is only set to enabled, then the system issues you a warning message to perform QC on the new reagent cartridge lot, but the system allows you to use the new lot with or without the QC and any existing lots.

Setting a Required QC Reminder

1. At the Home screen, select **Menu**.
2. Select **System Settings**.
3. Select **Additional Settings**.
4. Select **Control Tests**.
5. Select **New Lot Reminders**.

At the New Lots Reminders screen, checkboxes labeled Enabled and Required display for each of the following control tests:

- HbA_{1c} Normal
 - HbA_{1c} Abnormal
 - A/C Low
 - A/C High
6. To activate a Required QC reminder for the selected reagent test, select the Enabled checkbox and Required checkbox.

The Enabled checkbox must be selected before the Required checkbox.

Repeat step 6 for any additional tests, as needed.

7. Select **Save**.
8. The next time a patient test cartridge is scanned, the following occurs:
 - The system checks to see if a record of the Required QC was run. If a record is found, the patient test is run.
 - If the system does not find a record, a message displays requiring you to perform a QC and the patient test is stopped.

NOTE: You cannot run the selected test until the required QC is performed.

Customized QC Reminders

You can specify the QC reminder cycle in days. The available range is 7 to 60 days. This enables you to define a reminder cycle that supports variable site requirements. You also can select daily, weekly, or monthly QC reminder cycles.

To customize QC Reminders:

1. At the Home screen, select **Menu**.
2. Select **System Settings**.
3. Select **Additional Settings**.
4. Select **Control Tests**.
5. Select **Control Test Reminder**.

6. At the Control Test Reminder screen, select 1 of the following:

- HbA_{1c} Normal
- HbA_{1c} Abnormal
- A/C Low
- A/C High

Once selected, the Schedule button to the right of the control test selected becomes active.

7. Select **Schedule** for the selected test.

8. Select **Change**.

9. Select **Optional** or **Required**, and then select **Next**.

10. Select **Custom**.

A screen displays that enables you to select a number between 7 and 60 by pressing up or down arrow keys. The selected number displays above the arrow keys. The default value is 14.

Both up and down arrow keys cycle continuously through the 7 to 60 number range. For example, if 7 displays, pressing the down arrow key displays 60. Press the down arrow again to display 59, then 58, and so on.

11. Press an arrow key until the number you want displays.

12. Select **Next**.

13. Select the time in hours and minutes, using the arrow keys.

14. Select **AM** or **PM**.

15. Select **Next**.

The Settings screen displays. Verify the settings you entered are correct. If a setting is incorrect, select **Change**, and update the settings, as needed.

16. Select **Save**.

The Control Test Reminders screen displays.

17. Repeat steps 6 to 16 to set additional QC reminders, as needed.

6 Maintenance

Routine Cleaning

Maintenance Schedule

Weekly

Cleaning the Onboard Barcode Reader Window

Cleaning the Exterior

Quarterly

Changing the Air Filter

Optical Test

As Needed

Cleaning the Exterior

Changing the Air Filter

Removing and Cleaning the Cartridge Spring and Cartridge Area

Cleaning the Onboard Barcode Reader Window

Optical Test

Calibrating the Touchscreen

Replacing the Fuse



WARNING

Turn the power off and disconnect the power cord before cleaning the DCA Vantage system.

Turning Off the DCA Vantage System

Perform these steps to turn the system off:

NOTE: You do not have to reconfigure system settings when turning the power on, the system stores the saved settings.

1. At the Home screen, select **Turn Off**.
A message displays asking if you want to shut down the system.
 2. To shut down the system, select **Yes**.
The system begins shutting down.
 3. After shutdown completes, turn the power switch to the off position.
- NOTE:** Wait until shutdown completes before turning the power switch to the off position.

Cleaning the Onboard Barcode Reader Window



WARNING

Turn the power off and disconnect the power cord before cleaning the barcode window.

Materials Required:

- lint-free cloth
 - water or ethanol
1. Clean the barcode window with a lint-free cloth dampened with water or ethanol.

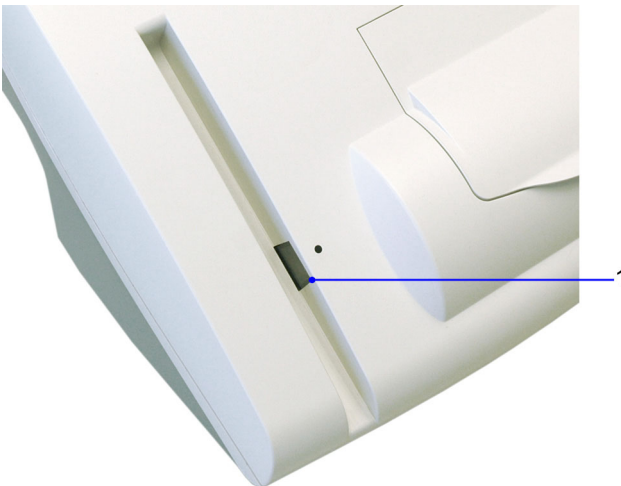

1 Onboard Barcode Reader

Figure 30 **Cleaning the Onboard Barcode Reader Window**

2. Connect the power cord after the barcode window is clean and dry.

Cleaning the External Barcode Reader Window

To clean the external barcode reader window, follow the manufacturer's instructions.

Cleaning the Exterior



WARNING

Turn the power off and disconnect the power cord before cleaning the exterior of the system.



CAUTION

Do not allow liquid to drip into system. If liquid drips into the system, you can damage the optics.

Materials Required:

- lint-free cloth
 - water or ethanol
1. Clean the exterior with a lint-free cloth dampened with water or ethanol.
 2. Connect the power cord after the exterior is clean and dry.

NOTE: If you want to disinfect the exterior of the system, expose the surface to 0.5% sodium hypochlorite for 10 minutes. Remove any liquid blood on the system before disinfection.



CAUTION

Do not use any other type of solvent, oil, grease, or silicone spray on any part of the system.

Removing and Cleaning the Cartridge Spring and Cartridge Area



WARNING

Turn the power off and disconnect the power cord before cleaning the cartridge compartment.



CAUTION

Do not allow liquid to drip into system. If liquid drips into the system, you can damage the optics.



BIOHAZARD

Wear personal protective equipment. Use universal precautions. Refer to *Safety Information*, page 169, for recommended precautions when working with biohazardous materials.

Materials Required:

- lint-free cloth
 - water or ethanol
 - paper clip or similar device
 - mild detergent
 - sponge swab
1. Ensure the power is off.
 2. Open the cartridge compartment door as far as possible.
 3. Wipe the inside surface of the compartment door and surfaces on both sides of the compartment using a lint-free cloth dampened with water or ethanol.
 4. Dry the surface using a clean, dry, lint-free cloth.
 5. Locate the cartridge return spring inside the cartridge holder.

6. Insert the tip of a straightened paper clip (or other like device) into the top hole on the spring.

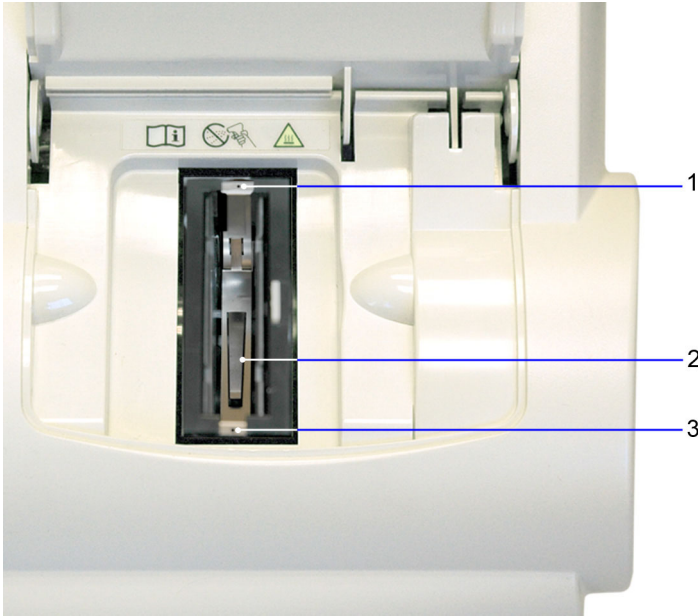
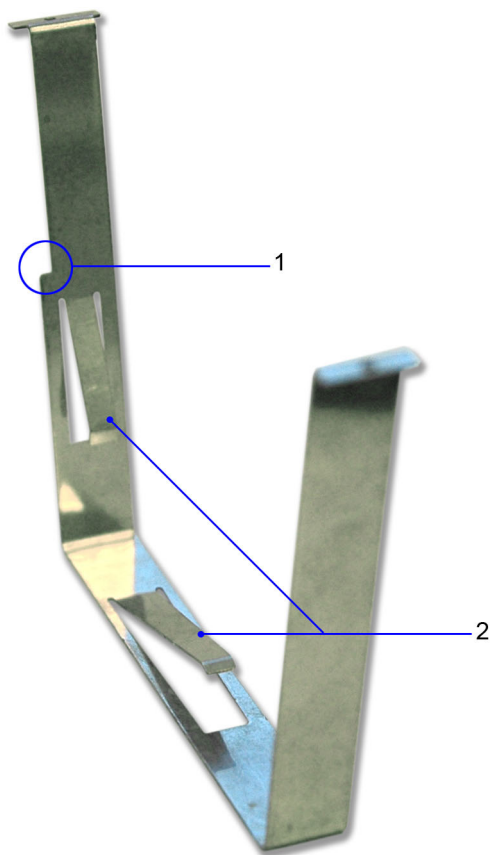

Figure 31 Return Spring in Cartridge Compartment

- 1 Top Hole
 - 2 Leaf Spring
 - 3 Bottom Hole
-
7. Gently pull the metal end towards the center of the cartridge compartment to release one side of the spring from the cartridge holder.
 8. Repeat step 6 to release the other side of the spring from the cartridge holder.

9. Pull the cartridge return spring completely out of the system.
10. Clean the cartridge return spring using any of the following items:
 - warm solution of mild detergent and water
 - lint-free cloth dampened in water or ethanol

NOTE: Ensure the leaf springs are not bent or damaged while cleaning. Damaged leaf springs do not function properly.



- 1 Spring Cut-out
- 2 Leaf Springs

Figure 32 Return Spring

11. Dry the cartridge return spring with a clean, lint-free cloth.

- Using a clean, dry, sponge swab (provided in the Cleaning Kit), remove any spilled liquid from the cartridge holder.



CAUTION

Do not use a cotton swab. Cotton fibers that are left on the surface can interfere with the system's optical systems.

- Rotate the cartridge holder with the compartment door partially closed to locate and remove any additional liquid.

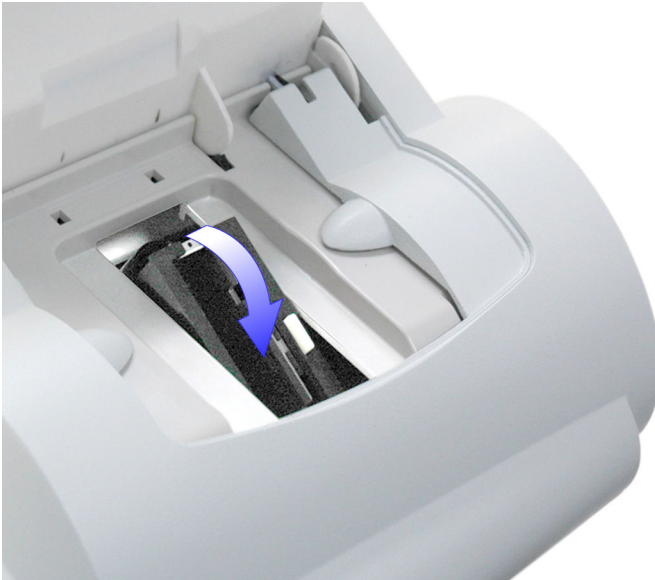

Figure 33 Rotating the Cartridge Compartment

- Dampen a sponge swab with water or ethanol.
- Clean the cartridge holder, rotating the cartridge holder as necessary.



CAUTION

Do not allow liquid to drip off of the sponge swab into the system. If liquid drips into the system, you can damage the optics.

- Locate the vertical grooves inside the cartridge compartment.
- Locate the front and back slots near the top of the compartment.
- Locate the leaf spring on one side of the cartridge return spring.

19. With the leaf spring oriented toward the back of the system, complete the following steps to lower the leaf spring into the system:
 - a. Hold on to both sides of the cartridge return spring.
 - b. Pinch the sides together and lower the spring into the system by sliding the sides of the spring between the vertical grooves in the compartment.
 - c. Release the spring.
 - d. Gently and carefully push down on the edge of the cartridge return spring and insert the edge into the slot.
 - e. Repeat Step **c** to attach the opposite side of the cartridge return spring to the cartridge compartment.

Cleaning the Cartridge Compartment Optical Window

1. Remove the air filter from the back of the instrument.
2. Rotate the cartridge holder with the compartment door partially closed to locate the optical window. See *Figure 33, Rotating the Cartridge Compartment*, page 103.
3. With the cartridge holder fully rotated, locate the two round holes on either side of the cartridge compartment. The optical window is the lower of the 2 openings, nearest the cover.

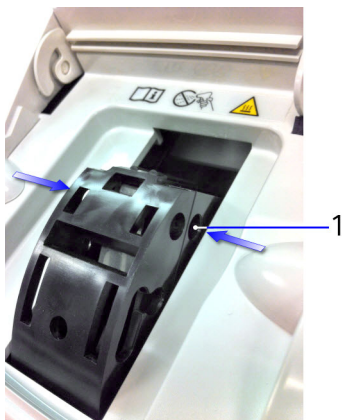

1 Optical window

Figure 34 Location of Optical Window Openings

4. Fully open the cartridge compartment cover.

- Using a canister of pressurized, compressed air, carefully direct the spray of air through the optical window holes on both sides of the cartridge holder, aiming the nozzle toward the side or back of the instrument.
-



CAUTION

When using compressed air, hold the canister as vertically as possible, tilting the instrument if necessary. If you hold the canister at a sharp angle to the vertical, liquid propellant can escape from the canister and damage the optics. You must hold the canister in a nearly vertical position to get only a spray of air with no liquid.

- Return the cartridge holder to its original position and close the compartment door.
- Replace the air filter.
- If the problem persists, contact the Siemens Technical Support Center or your local technical service provider.

Changing the Air Filter

Materials Required:

- air filter
- Remove the filter holder from the back of the system:
 - Pull the holder off from the top.



1 Filter Cover

Figure 35 Filter Location

2. Dispose of the old air filter.
3. Place the new air filter into the filter holder.



- 1 Air Filter
- 2 Air Filter Holder

Figure 36 Removing the Air Filter

4. Place the filter holder back on the system.

Performing Tests

Periodically you may need to run tests on the DCA Vantage system.

NOTE: You cannot use the external barcode reader to initiate tests.

Optical Test

The DCA Vantage system is designed to run a comprehensive series of self checks of the optical measurement system. These self checks are run automatically during every patient and Quality Control sample measurement. If any of the measurement criteria are out of specification, the system displays an error code and no result is given for that measurement.

In addition to the automatic self checks performed during every sample and Quality Control measurement, an optical test cartridge is available for you to run additional system performance checks before calling your local service provider for assistance. The main purpose of this test cartridge is to help you eliminate system hardware issues if errors are reported during sample and Quality Control measurements.

Use the optical test cartridge:

- When following troubleshooting steps in the Operator's Guide

- If Quality Control samples do not give the expected values
- During the installation procedure
- If you relocate the instrument
- As part of the as-needed and quarterly maintenance schedules

NOTE: The optical test cartridge is reusable; do not discard.

Optical Test Values

The optical test offers two options:

- Precision only—Runs during the first minute of testing and records the values for Mean Transmittance (Mean T) and Standard Deviation (SD T)
- Precision and drift—If selected, this test runs for an additional 5 minutes and measures the drift of the optics over 20 transmittance readings taken during that period. The measured values are Drift T, the average drift in transmittance, and Drift Max, the difference between the minimum and maximum transmittance of the 20 transmittance readings.

When the optical test completes, the DCA Vantage system displays the Mean T, SD T, Drift Max, and Drift T readings. Table 5 provides the value ranges for the Optical Tests.

Table 5 Optical Test Value Ranges

<i>Values</i>	<i>Range</i>
Mean Transmittance (Mean T)	0.95–1.05
Standard Deviation (SD T)	< 0.0015
Drift Max	< 0.0280
Drift T	No applicable limits

Performing an Optical Test

1. Locate the barcode on the optical test cartridge.
2. Hold the cartridge so that the barcode faces right.
3. Insert the cartridge into the barcode track.
4. Smoothly slide the cartridge down the barcode track.
A beep sounds to signal a successful scan.



Figure 37 Scanning the Optical Test Cartridge

5. Open the cartridge compartment door.
6. Hold the optical test cartridge so that the barcode faces to the right.

7. Insert the cartridge into the compartment until you hear a snap.

NOTE: The cartridge is designed to fit one way into the system.



Figure 38 Inserting the Optical Test Cartridge into Compartment

8. Close the door.
The test runs for 6 minutes.
9. Print the results.
10. Remove the cartridge:
 - a. Open the cartridge compartment door.
 - b. Locate the button on the right side of the cartridge compartment.
 - c. Push and hold down the button with your right hand.
 - d. Gently push the plastic tab on the cartridge to the right with your left hand.
This releases the cartridge.
 - e. Pull the cartridge out of the compartment.

System Tests

You or your technical support provider can use the System Test menu screen to perform tests on the DCA Vantage system. The System Test menu screen includes the following types of System Tests:

- User System Tests
- Service System Tests (Performed by your technical support provider.)

- Optical Tests

NOTE: If the system is set to restricted, to access System Tests you must enter an authorized Operator ID and access code, refer to *Operator IDs and Access Codes*, page 42.

Performing User System Tests

The User System Tests screen enables you to test the DCA Vantage system.

1. At the System Menu screen, select **System Tests**.
2. From the System Test menu, select **User System Tests**.
3. Select the check box of the test you want to perform.
4. To initiate the test, select **Start**.

The tests that require no additional action automatically run.

NOTE: Some options may not be available because they were not configured in your system.

The following table explains the different tests you can perform, if enabled, and if they require additional action:

If you select . . .	then. . .
Touchscreen	Select each numbered key. The key changes from a number to a check mark. If a section fails, the number remains. NOTE: The test times out if all the buttons are not selected within 60 seconds.
Sound	<ol style="list-style-type: none"> 1. Listen for an alert sound. 2. If you hear an alert sound, select Yes. 3. If you do not hear an alert sound, select No.
Door	Open and close the door to verify that the screen reflects the status of either the open or closed state.
Onboard Barcode Reader	Scan a DCA barcode with the onboard barcode reader to verify that the onboard barcode reader works properly.
External Barcode Reader	Scan a DCA barcode with the external barcode reader to verify that the external barcode reader works properly.
Onboard Printer	Verify that the onboard printer prints a report.
External Printer	Verify that the external printer prints a report.
Serial Port	After connecting a loopback connector, the system automatically runs the test.

If you select . . .	then. . .
Ethernet Port	After connecting to a valid network connection, the system automatically runs the test.
USB Port	After connecting a USB device, the system automatically runs the test.
Lamp	The system automatically runs the test.
Motor Control	The system automatically runs the test.
Measurement System	The system automatically runs the test.

Calibrating the Touchscreen

Calibrate the touchscreen if it does not respond correctly when you touch the screen.

1. At the System Test menu, select **Calibrate Touchscreen**.
2. When the Touchscreen Calibration screen displays, select the **X** target at the center of the screen.
3. Repeat when prompted at each corner.
The Touchscreen Calibration Complete screen displays.

User System Test Results

The User System Test Results screen displays the status of each system test you selected at the User System Test menu screen. The results display after the tests that require user action are complete and while the automatic tests are running on the system.

NOTE: You can cancel the tests while they are running.

System Settings

Use the System Settings menu to set and review the following system settings:

- change the sound volume
- adjust the contrast of the display
- access additional settings for the system
- view the current setting for the system

NOTE: You must restart the system if you restore system settings.

Loading Paper on the Onboard Printer



CAUTION

Do not touch the printer without observing precautions for handling electrostatic sensitive devices. A risk of electrostatic discharge to the system exists when touching the printer.

1. Ensure the system is at the Home screen.
2. Turn the system so that you are looking at the back.
3. Use the tab to lift the cover off.



WARNING

Be careful when touching the printer. It may be hot causing bodily injury.

4. Lift the paper feeder up.
5. Push the plastic paper cover down.
6. Remove the paper roll:
 - a. Lift up the roll.
 - b. Tear the paper between the roll and the printer.
 - c. Remove the core and remaining paper on the roll.
7. Remove any paper remaining in the printer:
 - a. Locate the printer paper release lever.
This lever is colored dark gray and is located on the right of the printer when looking at the front of the system.

- b. Pinch and lift the front of the lever to raise the paper guide.
- c. Carefully pull paper through the printer in its normal direction of travel.



- 1 Printer Cover
- 2 Paper Feeder

Figure 39 Removing the Printer Paper

- 8. Obtain a new paper roll.
- 9. Unroll sufficient paper to feed the printer.

10. Hold the roll just above the printer, with the paper unrolling from underneath.
11. Push the paper gently under the roller at the back of the printer.



Figure 40 Inserting Paper into the Printer

12. Load the paper into the paper feeder.



1 Printer Cover

2 Paper Feeder

Figure 41 Loading the Paper into the Feeder

13. Push the plastic tab to cover the paper.

14. Pull the paper feeder down.

15. Pinch and push down on the gray paper release lever to hold the paper in place.

16. Load the paper into the paper slot on the cover.
17. Close the cover.

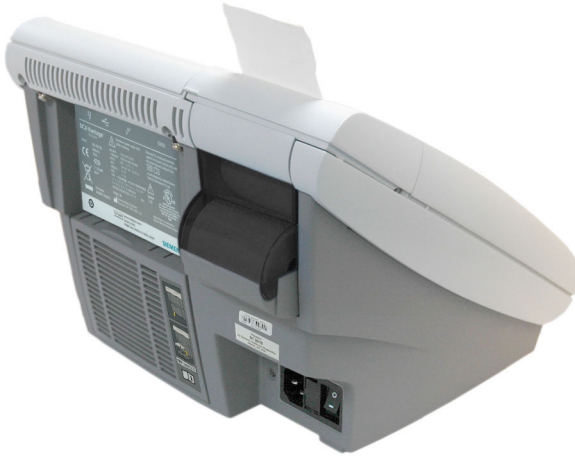

Figure 42 Closing the Cover

Replacing the Fuse

The fuse holder is located in the back panel between the power cord and the power switch. It contains 2 fuses; both fuses are required. There are 2 grooves above the fuse cover and 2 grooves below the fuse cover. Place the screwdriver blade in the smaller groove to remove the cover.

Materials Required:

- Flathead Screwdriver
- Fuse: 250 V, T-1.25 A



CAUTION

Set the power switch to Off. Disconnect the power cord from the wall outlet. Disconnect the power cord from the system.

1. Locate the 2 grooves on the top of the fuse holder.



CAUTION

Ensure you place the screwdriver blade in the smaller groove. You can damage the fuse block by placing the blade in the larger groove.

2. Insert the blade of a small flat-head screwdriver into the smallest groove.

3. Exert pressure to unsnap the top of the fuse holder.



- 1 Small Groove

Figure 43 Removing fuse holder

4. Repeat steps 2–3 for the bottom groove.
5. Remove the fuse holder from the system.

6. Remove and dispose of the blown fuse.

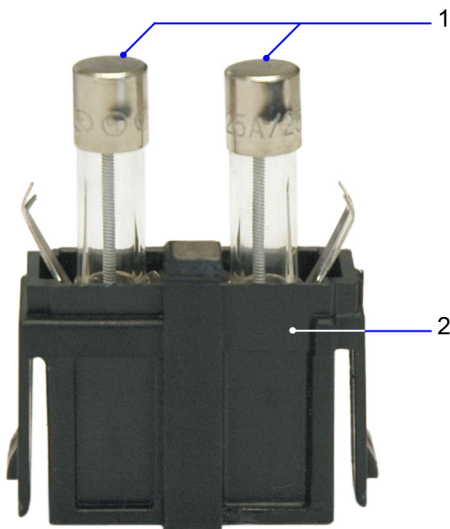

- 1 Fuse
- 2 Fuse Block

Figure 44 Fuse

7. Insert the spare fuse onto the fuse block.
8. Insert the fuse holder into the system.

Setting Maintenance Reminders

Use the Maintenance Reminders screen to access the Maintenance Task Log, and to view, set, or change the schedule for the maintenance tasks. The default setting is that none of the Maintenance Reminders are selected. After you select the check box for a specific reminder, Schedule becomes active.

1. At the Home screen, select **Menu**.
2. At the Menu screen, select **System Settings**.
3. At System Settings, select **Additional Settings**.
4. At the Additional Settings menu, select **Maintenance**.
5. To set a maintenance reminder, select the check box.
The maintenance reminder is set and Schedule becomes active.
6. To view the schedule, select **Schedule**.
7. To change the schedule, select **Change**.
The Maintenance Reminder Frequency screen displays.

8. Select one of the following frequency options:
 - Daily
 - Weekly
 - Monthly
 - Quarterly
9. Select **Next**.

The Set Maintenance Reminder Day screen displays.
10. Use the up and down arrows to select the day or date of the reminder.
11. Select **Next**.

The Maintenance Reminder Day screen displays.
12. Use the up and down arrows to set the time of the reminder.

NOTE: If a 12-hour clock is configured, you have to select AM or PM.
13. Select **Next**.

The Maintenance Reminder Information screen displays.
14. Select **Save**.

Viewing System Maintenance Status

Use the System Maintenance Status screen to view the list of maintenance tasks and the status of each task. After you have scheduled a task, you can mark a task as completed at this screen, then the task displays at the System Maintenance log screen.

NOTE: The maintenance task *must* be scheduled before you can mark it as completed. If the task is not scheduled, the Complete option is not available.

1. At the Home screen, select **Menu**.
2. At the Menu screen, select **System Maintenance**.

The System Maintenance Status screen displays with the status of each task.
3. To mark a task as complete select the scheduled task.
4. Select **Complete**.

System Maintenance Log

Use the System Maintenance Log screen to view all complete maintenance tasks and to delete all entries from the log.

Viewing the Maintenance Log

1. At the Home screen, select **Menu**.
2. At the Menu screen, select **System Settings**.
3. At System Settings, select **Additional Settings**.
4. At the Additional Settings menu, select **Maintenance**.
5. Select **Log**.
6. Use the up and down arrows to view all of the maintenance entries.
7. To delete all maintenance log entries, select **Delete All**.
8. Select **Yes**.
All log entries are deleted.

7 Troubleshooting

If an operational or system problem occurs, use the information in this section to correct the problem.

If you are unable to resolve the problem or have questions, contact your local technical support provider or distributor.

System Messages

System messages provide status and prompts to assist you while using the DCA Vantage system.

System Message	Comment
A/C High control test failed. You cannot perform A/C patient tests.	The albumin and creatinine quality control test failed. You must have a successful control test to perform patient tests.
A/C High control test requested by remote computer.	A computer connected to the system is sending a request for a test.
A/C High control test requested by remote computer. Patient test locked until the control test is run.	A computer connected to the system is sending a request for a QC test. You must wait to run the patient test until the control test completes.
A/C Low control test failed. You cannot perform A/C patient tests.	The albumin and creatinine quality control test failed. You must have a successful control test to perform patient tests.
A/C Low control test requested by remote computer.	A computer connected to the system is sending a request for a test.
A/C Low control test requested by remote computer. Patient test locked until the control test is run.	A computer connected to the system is sending a request for a QC test. You must wait to run the patient test until the control test completes.
Access Code is already in use.	
An optical test is required.	A reminder message that it is time to run the Optical Test using the Optical Test Cartridge. The frequency of the reminder is determined by your location.

System Message	Comment
Change the Air Filter.	A reminder message that it is time to replace the air filter. The frequency of the reminder is determined by your location.
Clean the Barcode window.	A reminder message that it is time to clean the onboard barcode reader window. The frequency of the reminder is determined by your location.
Clean the Cartridge Compartment.	A reminder message that it is time to clean the cartridge area. The frequency of the reminder is determined by your location.
Compressing the database, please wait.	
Data storage is at > 90% of the storage capacity. Change Storage setting to AUTO or delete some old tests.	Warning message to clear old tests.
Enabled ASTM ports are not ready to transmit data, please check connections.	Check the Ethernet and serial connections to ensure cables are secure.
HbA1c Abnormal control test failed. You cannot perform HbA1c patient tests.	The control test failed. Rerun the control test with a new control cartridge.
HbA1c Abnormal control test requested by remote computer.	
HbA1c Abnormal control test requested by remote computer. Patient test locked until the control test is run.	
HbA1c Normal control test failed. You cannot perform HbA1c patient tests.	
HbA1c Normal control test requested by remote computer.	
HbA1c Normal control test requested by remote computer. Patient test locked until the control test is run.	
Instrument is Initializing, please wait.	
Invalid user action.	

System Message	Comment
Operator ID is already in use.	
Perform A/C High control test.	
Perform HbA1c Normal control test.	
Perform A/C Low control test.	
Perform an Optical Test.	
Perform HbA1c Abnormal control test.	
Processing restricted, not ready for current command.	
Remote command received to lockout patient testing.	
Requested data was not found.	The values you searched for are not in the system.
Serial Number is not defined. Contact your technical support provider.	The serial number for your system is not in the system software.
Test cancelled due to cartridge load timeout.	The test was not started within the time limit.
The access code entered is not valid or access is denied. Please check with your supervisor.	
The activation key entered does not match any feature.	The key code you entered is not correct.
The database was corrupt and recovered from the system backup. Some data may be lost.	
The Door is open, to continue close the door.	The cartridge door was opened. The system will not continue processing tests until the door is securely closed.
The motor must be homed. Run the Motor Control Test.	
The system door was open during the test.	During a patient, control, or QC test, the cartridge door was opened. Close the door.
The system is in diagnostics mode.	
The system is warming up.	The system was powered on or power save mode was active.
This field must have at least one alphanumeric character.	

System Message	Comment
USB storage device is not available.	The system does not detect the USB device connected to the USB port.
User-Initiated cancel.	The operator selected the Cancel button to stop a system activity.
Waiting for ASTM transmission to complete, please wait.	The system is transferring data. Wait for the transfer to complete before continuing using the system.
You cannot perform HbA1c patient tests using this cartridge Lot Number. Perform an HbA1c Abnormal Control Test for this cartridge Lot Number.	
You cannot perform HbA1c patient tests using this cartridge Lot Number. Perform HbA1c Normal and Abnormal Control Tests for this cartridge Lot Number.	
You cannot perform HbA1c patient tests using this cartridge Lot. Perform an HbA1c Normal Control Test for this cartridge Lot Number.	
You cannot perform A/C patient tests using this cartridge Lot Number. Perform an A/C High Control Test for this cartridge Lot Number.	
You cannot perform A/C patient tests using this cartridge Lot Number. Perform A/C High and Low Control Tests for this Lot Number.	
You cannot perform A/C patient tests using this cartridge Lot Number. Perform an A/C Low Control Test for this Lot Number.	

Troubleshooting the System

If the system is not responding correctly, find the symptom and follow the recommended action to correct the problem.

Symptom	Possible Cause	Action
Barcode cannot be read using external barcode reader	Is the barcode reader cable connected to the system?	Verify the connections on the back of the system. Refer to <i>Hardware Installation</i> , page 25.

Symptom	Possible Cause	Action
Barcode cannot be read using external barcode reader (continued)	Does the barcode reader need to be cleaned?	Refer to <i>Cleaning the Onboard Barcode Reader Window</i> , page 98.
	Is the barcode reader working properly?	Run the External barcode test. Refer to <i>Testing the External Barcode Reader</i> , page 197.
	Is the reader enabled in the system software?	Refer to <i>Installing the External Barcode Reader</i> , page 196.
	Is the reader held too close or too far from the label?	Rescan the barcode label while moving the reader closer or further to the label.
Barcode cannot be read using either the onboard or external barcode reader	Is the barcode symbology supported?	Refer to <i>Barcode Symbols and Labels Specifications</i> , page 195.
	Are you scanning from an appropriate menu?	Is the cursor in a demographic field? You must scan patient and QC information within a demographic field. For example, Patient ID, Sample ID.
	Is the barcode format correct?	Refer to <i>Barcode Symbols and Labels Specifications</i> , page 195.
	Is the background reflection too high or low?	Rescan the barcode label while moving the reader closer or further to the label.
Barcode cannot be read using the Onboard barcode reader	Not at the Home Screen.	Ensure you are at the Home Screen before scanning the cartridge.
	Are you scanning the cartridge too quickly?	Rescan the cartridge using a slower motion. If you are still having problems, try scanning upward instead of down.

Symptom	Possible Cause	Action
Barcode cannot be read using the Onboard barcode reader (continued)	Ensure the barcode is facing the correct direction.	Refer to <i>Scanning the Reagent Cartridge</i> , page 54.
	Is the label smudged or contains extra marks?	Verify label is clean and clear of extra markings.
	Does the problem only occur when scanning the calibration card?	The Calibration card must be held flat against the scanner slot or it will not read the barcode.
	Does the problem only occur when scanning the reagent barcode?	Document the issue with the reagent lot and replace the reagent. Contact your local support provider.
	Did you scan the same side of the Microalbumin or Creatinine card twice?	When calibrating Microalbumin or Creatinine, after scanning side 1, the system prompts you to scan side 2. If you scan side 1 again, the system ignores the scan.
Buffer Tab Hard to Pull	If you pull the foil tab too fast, it can tear the foil and impede the full buffer release	Slowly pull the buffer tab while anchoring the cartridge with 2 fingers.
Calibration Lot Expired	Check the date on the control card. If the date is valid, the DCA Vantage system may be set with an incorrect date.	Refer to <i>Setting the Date Format and Current Date</i> , page 164.
Cartridge is stuck in the instrument		If the cartridge tab has broken off, do not try to remove the cartridge. Contact your local technical support provider.

Symptom	Possible Cause	Action
		If the cartridge tab is not broken and you are unable to remove the cartridge using the steps in <i>Removing the Reagent Cartridge</i> , page 62, contact your local technical support provider.
Cartridge is difficult to remove from the instrument.		After removing the cartridge, follow the steps in <i>Removing and Cleaning the Cartridge Spring and Cartridge Area</i> , page 100. When the system returns to normal operating temperature, perform the steps in <i>Optical Test</i> , page 107.
Cartridge is wet when removing from the instrument.		After removing the cartridge, follow the steps in <i>Removing and Cleaning the Cartridge Spring and Cartridge Area</i> , page 100. When the system returns to normal operating temperature, perform the steps in <i>Optical Test</i> , page 107.
Door Open error	Reagent compartment door is open.	Verify all compartment doors are closed. Rerun the test.
	Reagent compartment door sensor is defective.	If this problem continues after verifying doors are closed, contact your local technical support provider.
Display is blank	Is the power cord connected to the system and the electrical outlet?	Check that the power cord is firmly connected to the system and into a live electrical outlet.
	Is the system turned off?	Turn system power on.
	Is the system in power save?	Touch the screen, open a cartridge compartment door or use the internal barcode scanner to resume operations.
	Touchscreen electronics are defective.	Contact your local technical support provider.
Display is dim	Contrast is set too low.	Adjust contrast. Refer to <i>Setting the System Display</i> , page 166.

Symptom	Possible Cause	Action
External Printer is not working	Is the printer enabled in software and connected to the system?	Verify that the printer cable is connected. Verify that the external printer is enabled. Refer to <i>Setting up the External Printer</i> , page 30.
Instrument is inactive	Is the power cord connected to the back of the system and the electrical outlet?	Verify the power cord is properly connected.
	Fuse may be blown.	Inspect and replace the fuse if needed. Refer to <i>Replacing the Fuse</i> , page 117.
	Is the electrical outlet working?	Ensure the instrument is plugged into an active electrical outlet.
Onboard Printer is not working	Is the printer enabled in software?	Verify that the external printer is enabled. Refer to <i>Setting up the External Printer</i> , page 30.
	Is there paper in the printer. Is it loaded correctly? Is the printer door closed?	Check the printer area.
	Graphical patient test data does not print to the onboard printer.	The internal printer does not support printing graphs. An external printer is required.
Test Cancelled	Test not started within 15 minutes of scanning the reagent cartridge.	Rerun test within the time parameters.
Test will not start	A door is open.	Verify all doors are closed.
	Not at Home screen, system is not ready, or error codes require correction before running test.	Return to the Home screen. The Home screen should display Ready. If an error code displays, correct the error to continue.
	Calibration data does not exist for the reagent lot.	No calibration data for the lot of Reagent Cartridges. You must enter the calibration data to continue.

Symptom	Possible Cause	Action
Touchscreen not responding or not responding correctly.	Touchscreen needs to be calibrated.	Run the touchscreen calibration. Refer to <i>Calibrating the Touchscreen</i> , page 112.

Troubleshooting Reagent Messages

These message display when an error occurs with the reagent cartridge.

Symptom	Possible Cause	Action
Reagent not absorbed by cartridge filter at the end of the test.	The DCA Vantage system is not on a level work surface.	Verify that the system is properly installed on a level surface.
	The filter in the capillary holder is not absorbent.	Contact your local technical support provider.
Thermal Dot has reacted (HbA _{1c} reagents only)	Product was not shipped or stored properly.	There are 2 indicators: outside and inside. The outer shipper has an over temperature indicator. If this indicator is red or black, the product was not stored properly. Check the inside indicator to confirm. If the inside indicator is red, the cartridges should be discarded. The outside indicator can be red or black, while the inside indicator is normal. In this case, the cartridges can be used.

Errors Codes and Corrective Actions

This section of the guide lists error codes and messages, along with a description and corrective actions.

If the you cannot correct the error or the problem persists, record the error code and contact your local technical service provider for assistance.

Error Code	Description	Corrective Action
E3	The DCA Vantage system is unable to access the memory device containing the software update (usually a USB drive).	<ol style="list-style-type: none"> 1. Re-insert the USB memory device used for the software updates. 2. Select OK in the error message dialog box. <p>The system reboots and retries to access the USB.</p>
E10	The Home/Index sensor failed to detect light to dark or dark to light transitions during a motor homing operation.	<ol style="list-style-type: none"> 1. Discard the sample. 2. Restart the system. 3. Rerun the test.
	<p>Or</p> <p>The offset between the home position determined from the Home/Index sensor and the position for the optimum optical signal is greater than +/- 4 half steps.</p>	
E12	The wrong number of Home/Index sensor transitions were detected during a motor rotation operation.	<ol style="list-style-type: none"> 1. Discard the sample. 2. Restart the system. 3. Rerun the test.
E20	A Dark reading (mean of 16) for a sample or reference channel is outside the acceptance range. This may indicate an electronic failure.	Contact your local technical support provider.

Error Code	Description	Corrective Action
E21 Lamp Failure	An Air reading for the Sample or Reference channel is too low. Possible causes: <ul style="list-style-type: none"> • incorrect position of cartridge holder • lamp failure • lamp drive circuit 	<ol style="list-style-type: none"> 1. Discard the sample. 2. Power off the system. 3. Clean the cartridge area. Refer to <i>Removing and Cleaning the Cartridge Spring and Cartridge Area</i>, page 100. 4. Restart the system.
E22 Optical reading is out of range	A Sample or Reference channel reading taken during an Air measurement is too high. Possible causes: <ul style="list-style-type: none"> • failure of lamp drive circuit • optical system 	<ol style="list-style-type: none"> 1. Discard the sample. 2. Power off the system. 3. Clean the cartridge area. Refer to <i>Removing and Cleaning the Cartridge Spring and Cartridge Area</i>, page 100. 4. Restart the system.
E23 Excessive noise on the Sample channel	The standard deviation of the 16 readings at the Sample channel for Dark or Air reading is too large. Possible causes: <ul style="list-style-type: none"> • low lamp intensity • lamp alignment/rotation • lamp intensity variation 	<ol style="list-style-type: none"> 1. Discard the sample. 2. Power off the system. 3. Clean the cartridge area. Refer to <i>Removing and Cleaning the Cartridge Spring and Cartridge Area</i>, page 100. 4. Check/replace the air filter. 5. Clean the cartridge holder with compressed air while rotating. 6. Restart the system. 7. Run an optical test.
E24 Excessive noise on the Reference channel	The standard deviation of the 16 readings at the Reference channel for Dark, Air, or Sample reading is too large. Possible causes: <ul style="list-style-type: none"> • low lamp intensity • lamp alignment/rotation • lamp intensity variation 	<ol style="list-style-type: none"> 1. Discard the sample. 2. Power off the system. 3. Clean the cartridge area. Refer to <i>Removing and Cleaning the Cartridge Spring and Cartridge Area</i>, page 100. 4. Check/replace the air filter. 5. Clean the cartridge holder with compressed air while rotating. 6. Restart the system. 7. Run an optical test.

Error Code	Description	Corrective Action
E26 Excessive noise in sample reading	<p>The standard deviation of the 16 readings at the Sample channel during a reading taken is too large in Sample read position.</p> <p>Possible causes:</p> <ul style="list-style-type: none"> • low lamp intensity • lamp alignment/ rotation • lamp intensity variation 	<ol style="list-style-type: none"> 1. Discard the sample. 2. Power off the system. 3. Clean the cartridge area. Refer to <i>Removing and Cleaning the Cartridge Spring and Cartridge Area</i>, page 100. 4. Restart the system.
E27 Excessive Lamp Drift	<p>The change in mean signal between successive Air readings is too large at either the Sample channel or the Reference channel.</p> <p>Possible causes:</p> <ul style="list-style-type: none"> • dust in the optical path • lamp filament orientation 	<ol style="list-style-type: none"> 1. Discard the sample. 2. Power off the system. 3. Clean the cartridge area. Refer to <i>Removing and Cleaning the Cartridge Spring and Cartridge Area</i>, page 100. 4. Restart the system.
E30 Thermal control system error - low	<p>The temperature measured by one of the cartridge holder thermistors is $\leq 2^{\circ}$ C.</p> <p>Possible causes:</p> <ul style="list-style-type: none"> • defective heater plate • defective thermistor assembly • defective connector • defective electrical circuit 	<ol style="list-style-type: none"> 1. Discard the sample. 2. Restart the system.

Error Code	Description	Corrective Action
E31 Cartridge temperature is very low	<p>The temperature measured by one of the cartridge holder thermistors is $< (T_{\text{setpoint}} - 12.9)^{\circ} \text{C}$ while the system is idle, during an Optical Test, during the first 5 minutes of an HbA_{1c} test, or the first 5 minutes of a Microalbumin/Creatinine test.</p> <p>Possible causes:</p> <ul style="list-style-type: none"> • cold cartridge • defective heater plate • defective thermistor assembly • defective connector • defective electrical circuit 	<ol style="list-style-type: none"> 1. Ensure the reagent cartridge was properly prepared for testing. Reagents should be at room temperature for testing. 2. Power off the system. 3. Rerun the test.
E32 Cartridge temperature too low during measurement	<p>The temperature measured by one of the cartridge holder thermistors.</p> <p>Possible causes:</p> <ul style="list-style-type: none"> • cold cartridge • defective heater plate • defective thermistor assembly • defective connector • defective electrical circuit 	<ol style="list-style-type: none"> 1. Ensure the reagent cartridge was properly prepared for testing. Reagents should be at room temperature for testing. 2. Power off the system. 3. Rerun the test.

Error Code	Description	Corrective Action
E33 Cartridge temperature too high during measurement	<p>The temperature measured by one of the cartridge holder thermistors.</p> <p>Possible causes:</p> <ul style="list-style-type: none"> • cold cartridge • defective heater plate • defective thermistor assembly • defective connector • defective electrical circuit 	<ol style="list-style-type: none"> 1. Ensure the reagent cartridge was properly prepared for testing. Reagents should be at room temperature for testing. 2. Power off the system. 3. Rerun the test.
E34 Cartridge temperature very high	<p>The temperature measured by one of the cartridge holder thermistors.</p> <p>Possible causes:</p> <ul style="list-style-type: none"> • cold cartridge • defective heater plate • defective thermistor assembly • defective connector • defective electrical circuit 	<ol style="list-style-type: none"> 1. Ensure the reagent cartridge was properly prepared for testing. Reagents should be at room temperature for testing. 2. Power off the system. 3. Rerun the test.
E35 Thermal control system error - high	<p>The temperature measured by one of the cartridge holder thermistors is $\geq 50^{\circ}$ C.</p> <p>Possible causes:</p> <ul style="list-style-type: none"> • defective heater plate • defective thermistor assembly • defective electrical circuit 	<ol style="list-style-type: none"> 1. Restart the system. 2. Rerun the test.

Error Code	Description	Corrective Action
E36 Temperature control failure	<p>10 minutes after you start the system the cartridge temperature has not reached the operating range or the cartridge temperature remains outside the same operating range for more than 10 minutes.</p> <p>Possible causes:</p> <ul style="list-style-type: none"> • defective heater plate • defective thermistor assembly • defective connector • defective heater driver • other electronics 	<ol style="list-style-type: none"> 1. Restart the system. 2. Rerun the test.
E37 Internal instrument temperature error–low	<p>The temperature measured by the ambient temperature thermistor is $\leq 2^{\circ}$ C.</p> <p>Possible causes:</p> <ul style="list-style-type: none"> • damaged ambient temperature thermistor • circuit failure 	<ol style="list-style-type: none"> 1. Restart the system. 2. Rerun the test.
E38 Internal instrument temperature error–high	<p>The temperature measured by the ambient temperature thermistor is $\geq 50^{\circ}$ C.</p> <p>Possible causes:</p> <ul style="list-style-type: none"> • damaged ambient temperature thermistor • circuit failure 	<ol style="list-style-type: none"> 1. Restart the system. 2. Rerun the test.

Error Code	Description	Corrective Action
E40 Barcode read error	The number of digits read by the barcode reader does not match what is expected. Possible causes: <ul style="list-style-type: none"> • incorrect barcode • partial barcode scan • barcode reader is not working properly 	<ul style="list-style-type: none"> • Rescan the barcode in a different direction. • Clean the barcode window. • Use another barcode label.
E41 Incorrect barcode data	The barcode has the correct number of digits, but the character does not match the expected pattern. Possible causes: <ul style="list-style-type: none"> • incorrect barcode • partial barcode scan • barcode reader is not working properly 	<ul style="list-style-type: none"> • Rescan the barcode in a different direction. • Clean the barcode window. • Use another barcode label.
E50 Serial Port communication failure	An attempt to communicate with an LIS or remote computer via the RS232 serial port failed.	<ol style="list-style-type: none"> 1. Verify the cables are connected securely. 2. Verify the serial port is enabled in software. Refer to <i>Setting up the Serial Port Connection</i>, page 33. 3. Restart the system.
E51 Serial Port communication error	Communication with the serial port is not successful, even after numerous attempts.	<ol style="list-style-type: none"> 1. Disable the serial port. 2. Verify serial port is enabled in software. Refer to <i>Setting up the Serial Port Connection</i>, page 33. 3. Restart the system. 4. Contact your local technical support provider.

Error Code	Description	Corrective Action
E55 Ethernet port communication failure	An attempt to communicate via the Ethernet serial port failed.	<ol style="list-style-type: none"> 1. Verify the cables connecting the DCA Vantage system and the computer interface are securely connected. 2. Verify the DCA Vantage system has the correct configuration for the host device (baud rate, parity). 3. Disable and enable the Ethernet port. 4. Restart the system.
E56 Ethernet port communication error	Communication with the Ethernet port is not successful, even after numerous attempts. This error occurs after an E55 error.	<ol style="list-style-type: none"> 1. Verify the cables connecting the DCA Vantage system and the computer interface are securely connected. 2. Verify the DCA Vantage system has the correct configuration for the host device (baud rate, parity). 3. Disable and enable the Ethernet port. 4. Restart the system.
E60 Database Failure	The database is not functioning properly. The database may be corrupted or the system was not properly powered down.	<ol style="list-style-type: none"> 1. Turn off the instrument from the Home screen and wait until system shutdown is complete. 2. Restart the system.
E61 Database read error	When attempting to read the database, the read operation fails, resulting in the return of no data or corrupt data.	<ol style="list-style-type: none"> 1. Turn off the instrument from the Home screen and wait until system shutdown is complete. 2. Restart the system.
E62 Database write error	An error is returned from a database write operation. The database may be corrupted.	Restart the system.

Error Code	Description	Corrective Action
E63 Database is full	The database is filled to the allotted capacity for storing sample test results.	Delete some old data records by: <ul style="list-style-type: none"> • Deleting specific old data records. • Setting the system to automatic purge mode.
E70 Internal Printer Failure	The internal printer failed because of a hardware error.	<ol style="list-style-type: none"> 1. Acknowledge the error. 2. Restart the system.
E71 External Printer Failure	The external printer failed because of a hardware error.	<ol style="list-style-type: none"> 1. Acknowledge the error. 2. Verify the cables are securely connected.
E99 Internal System Error	An internal system failure occurred.	Contact your local technical support provider.
E101 HbA _{1c} Cartridge Error - buffer absorbance is too low	<p>The mean transmittance of the buffer readings is too high.</p> <p>Possible causes:</p> <ul style="list-style-type: none"> • No cartridge is present. • There is an optical alignment problem. 	<ol style="list-style-type: none"> 1. Discard the sample. 2. Acknowledge the error. The system is ready. 3. Repeat the test with a new cartridge. 4. If the error still occurs, contact your local technical support.
E102 HbA _{1c} Cartridge Error - buffer absorbance is too high	<p>The mean transmittance of the buffer readings is too low.</p> <p>Possible causes:</p> <ul style="list-style-type: none"> • There is condensation on the cartridge • Cartridge is not located in the proper position • Buffer tab is not removed • Optical window has a defect 	<ol style="list-style-type: none"> 1. Discard the sample. 2. Acknowledge the error. The system is ready. 3. Verify that the cartridge is inserted completely. 4. Pull the flexible tab. 5. Repeat the test with a new cartridge. 6. If the error still occurs, run the optical test cartridge.

Error Code	Description	Corrective Action
E103 HbA _{1c} Cartridge Error - high variation in buffer readings	The coefficient of variation (%CV) of the 10 transmittance readings of the buffer solution in the reagent cartridge is too high. Possible cause: <ul style="list-style-type: none"> condensation on the cartridge. 	<ol style="list-style-type: none"> Discard the sample. Acknowledge the error. The system is ready. Repeat the test with a new cartridge. If the error still occurs, contact your local technical support.
E104 HbA _{1c} Sample Error - low total hemoglobin	The transmittance of the blood pickup reading is too high. Possible causes: <ul style="list-style-type: none"> No or low blood reaction. No capillary holder was inserted Improper constitution of controls or use of non-DCA controls Hemoglobin < 7 g/dL = anemic patient Buffer tab is not removed 	<ol style="list-style-type: none"> Discard the sample. Acknowledge the error. The system is ready. Repeat the test with a new sample. <p>NOTE: Wait no more than 5 minutes after filling the capillary to start the test.</p> <ol style="list-style-type: none"> If the error still occurs, contact your local technical support.
E105 HbA _{1c} Sample Error - high total hemoglobin	The transmittance of the blood pickup reading is too low. Possible causes: <ul style="list-style-type: none"> Excess blood on capillary Irregularity in patient red blood cells (rare) Hemoglobin > 24 g/dL = patient has abnormally high hemoglobin 	<ol style="list-style-type: none"> Discard the sample. Acknowledge the error. Repeat the test with a new sample. Verify that the capillary has no excess blood on the capillary holder. If the error still occurs, contact your local technical support.

Error Code	Description	Corrective Action
E106 HbA _{1c} Sample Error - low total hemoglobin	<p>The mean transmittance of the hemoglobin readings is too high.</p> <p>Possible causes:</p> <ul style="list-style-type: none"> • no or low blood reaction • no capillary holder was inserted • improper constitution of controls or use of non-DCA controls • hemoglobin < 7 g/dL = anemic patient • buffer tab is not removed 	<ol style="list-style-type: none"> 1. Discard the sample. 2. Acknowledge the error. The system is ready. <p>NOTE: Wait no more than 5 minutes after filling the capillary to start the test.</p> <ol style="list-style-type: none"> 3. Repeat the test with a new sample.
E107 HbA _{1c} Sample Error - high total hemoglobin	<p>The mean transmittance of the hemoglobin readings is too low.</p> <p>Possible causes:</p> <ul style="list-style-type: none"> • excess blood on capillary • irregularity in patient red blood cells (rare) • hemoglobin > 24 g/dL = patient has abnormally high hemoglobin 	<ol style="list-style-type: none"> 1. Discard the sample. 2. Acknowledge the error. The system is ready. 3. Repeat the test with a new sample. 4. Verify that the capillary has no excess blood on the capillary holder. 5. If the error still occurs, contact your local technical support.
E108 HbA _{1c} Cartridge Error - high variable in hemoglobin measurement	<p>The %CV of the transmittance of the hemoglobin readings too large. (Particulate contamination.)</p>	<ol style="list-style-type: none"> 1. Discard the sample. 2. Acknowledge the error. The system is ready. 3. Repeat the test with a new sample. 4. If the error still occurs, contact your local technical support.

Error Code	Description	Corrective Action
E109 HbA _{1c} Cartridge error - reading for glycated hemoglobin is too low	The absorbance of one of the agglutinations is too low. Possible cause: <ul style="list-style-type: none"> cartridge exposed to excessive humidity or temperature 	<ol style="list-style-type: none"> Discard the sample. Acknowledge the error. The system is ready. Repeat the test with a new sample. <p>NOTE: Verify that the reagent kit was stored properly.</p> <ol style="list-style-type: none"> If the error still occurs, contact your local technical support.
E110 HbA _{1c} Cartridge Error - reading for glycated hemoglobin is too high	The absorbance of one of the agglutinations is too high. Possible cause: <ul style="list-style-type: none"> cartridge exposed to excessive humidity or temperature 	<ol style="list-style-type: none"> Discard the sample. Acknowledge the error. The system is ready. Repeat the test with a new sample. <p>NOTE: Verify that the reagent kit was stored properly.</p> <ol style="list-style-type: none"> If the error still occurs, contact your local technical support.
E111 HbA _{1c} Cartridge Error - low glycated hemoglobin response	The delta in absorbance between the first and the last agglutination readings is too low. Possible cause: <ul style="list-style-type: none"> cartridge exposed to excessive humidity or temperature 	<ol style="list-style-type: none"> Discard the sample. Acknowledge the error. The system is ready. Repeat the test with a new sample. <p>NOTE: Verify that the reagent kit was stored properly.</p> <ol style="list-style-type: none"> If the error still occurs, contact your local technical support.
E112 HbA _{1c} Cartridge Error - very large glycated hemoglobin response	The delta in absorbance between the first and last agglutination reading is too high. Possible cause: <ul style="list-style-type: none"> cartridge exposed to excessive humidity or temperature 	<ol style="list-style-type: none"> Discard the sample. Acknowledge the error. The system is ready. Repeat the test with a new sample. <p>NOTE: Verify that the reagent kit was stored properly.</p> <ol style="list-style-type: none"> If the error still occurs, contact your local technical support.

Error Code	Description	Corrective Action
E113 HbA _{1c} Cartridge Error - irregular reaction kinetics (A ₁)	<p>The A₁ parameter is an unexpectedly large negative number.</p> <p>Possible cause:</p> <ul style="list-style-type: none"> cartridge exposed to excessive humidity or temperature 	<ol style="list-style-type: none"> Discard the sample. Acknowledge the error. The system is ready. Repeat the test with a new sample. <p>NOTE: Verify that the reagent kit was stored properly, and that the foil package was opened just prior to use.</p> <ol style="list-style-type: none"> If the error still occurs, contact your local technical support.
E114 HbA _{1c} Cartridge Error - irregular reaction kinetics (A ₂)	<p>The A₂ parameter is too large.</p> <p>Possible cause:</p> <ul style="list-style-type: none"> cartridge exposed to excessive humidity or temperature 	<ol style="list-style-type: none"> Discard the sample. Acknowledge the error. The system is ready. Repeat the test with a new sample. <p>NOTE: Verify that the reagent kit was stored properly, and that the foil package was opened just prior to use.</p> <ol style="list-style-type: none"> If the error still occurs, contact your local technical support.
E115 HbA _{1c} Cartridge Error - final hemoglobin reading is greater than the previous check point	<p>The difference between the blood pickup absorbance and the mean hemoglobin absorbance is too large.</p> <p>Possible cause:</p> <ul style="list-style-type: none"> blood left in the capillary too long 	<ol style="list-style-type: none"> Discard the sample. Acknowledge the error. The system is ready. Repeat the test with a new sample. <p>NOTE: Wait no more than 5 minutes after filling the capillary to start the test.</p> <ol style="list-style-type: none"> If the error still occurs, contact your local technical support.

Error Code	Description	Corrective Action
E116 HbA _{1c} Cartridge Error - irregular reaction kinetics (high variability)	The Mean Squared Error calculated is too large. Possible cause: <ul style="list-style-type: none"> cartridge exposed to excessive humidity or temperature 	<ol style="list-style-type: none"> Discard the sample. Acknowledge the error. Repeat the test with a new sample. <p>NOTE: Verify that the reagent kit was stored properly, and that the foil package was opened just prior to use.</p> <ol style="list-style-type: none"> If the error still occurs, contact your local technical support.
E301 Microalbumin/ Creatinine Cartridge Error - buffer absorbance is too low	The mean transmittance of the buffer readings is too high. Possible causes: <ul style="list-style-type: none"> no cartridge is present, and there is an optical alignment problem 	<ol style="list-style-type: none"> Discard the sample. Acknowledge the error. Repeat the test. If the error still occurs, contact your local technical support.
E302 Microalbumin/ Creatinine Cartridge Error - buffer absorbance is too high	The mean transmittance of the buffer readings is too low. Possible causes: <ul style="list-style-type: none"> condensation on the cartridge cartridge is not located in the proper position buffer tab is not removed optical window has a defect 	<ol style="list-style-type: none"> Discard the sample. Acknowledge the error. Repeat the test. Verify that cartridge is inserted completely into the system. Remove the flexible tab. If the error still occurs, contact your local technical support.
E303 Microalbumin/ Creatinine Cartridge Error - variable buffer readings	The percent coefficient of variation (%CV) of the 10 transmittance readings of the buffer solution in the reagent cartridge is too high. (Particulate contamination.)	<ol style="list-style-type: none"> Discard the sample. Acknowledge the error. Repeat the test. If the error still occurs, contact your local technical support.

Error Code	Description	Corrective Action
E304 Microalbumin/ Creatinine Cartridge Error - sample blanks absorbance is too low	The percent coefficient of variation (%CV) of the 10 transmittance readings of the buffer solution in the reagent cartridge is too high. (Particulate contamination.)	<ol style="list-style-type: none"> 1. Discard the sample. 2. Acknowledge the error. 3. Repeat the test. <p>If the error still occurs, contact your local technical support.</p>
E305 Microalbumin/ Creatinine Cartridge Error - sample blank absorbance is too high	<p>The mean transmittance of the low sample blank is too low.</p> <p>Possible cause:</p> <ul style="list-style-type: none"> • urine sample is turbid or highly pigmented 	<ol style="list-style-type: none"> 1. Discard the sample. 2. Acknowledge the error. 3. Centrifuge the sample before assaying if the sample is cloudy. 4. Repeat the test. 5. If the error still occurs, contact your local technical support.
E306 Microalbumin/ Creatinine Cartridge Error -high variability in transmittance of sample blank	The %CV of the low sample blank is too high. (Particulate contamination.)	<ol style="list-style-type: none"> 1. Discard the sample. 2. Acknowledge the error. 3. Repeat the test. 4. If the error still occurs, contact your local technical support.
E307 Microalbumin/ Creatinine Cartridge Error - Microalbumin absorbance is too low	<p>The mean of the Microalbumin transmittance readings is too high.</p> <p>Possible cause:</p> <ul style="list-style-type: none"> • cartridge exposed to excessive temperature or humidity 	<ol style="list-style-type: none"> 1. Discard the sample. 2. Acknowledge the error. 3. Repeat the test. <p>NOTE: Verify that the reagent was stored properly.</p> <ol style="list-style-type: none"> 4. If the error still occurs, contact your local technical support.
E308 Microalbumin/ Creatinine Cartridge Error - Microalbumin absorbance is too high	The mean of the Microalbumin transmittance readings is too low.	<ol style="list-style-type: none"> 1. Discard the sample. 2. Acknowledge the error. The system is ready. 3. Repeat the test. <p>NOTE: Verify that the reagent was stored properly.</p> <ol style="list-style-type: none"> 4. If the error still occurs, contact your local technical support.

Error Code	Description	Corrective Action
E309 Microalbumin/ Creatinine Cartridge Error - high variation in Microalbumin readings	The %CV of the Microalbumin transmittance reading is too high. (Particulate contamination.)	<ol style="list-style-type: none"> 1. Discard the sample. 2. Acknowledge the error. The system is ready. 3. Repeat the test. 4. If the error still occurs, contact your local technical support.
E310 Microalbumin/ Creatinine Cartridge Error - Creatinine absorbance is too low	One of the creatinine absorbance readings is too low. Possible cause: <ul style="list-style-type: none"> • cartridge exposed to excessive temperature or humidity 	<ol style="list-style-type: none"> 1. Discard the sample. 2. Acknowledge the error. The system is ready. 3. Repeat the test. <p>NOTE: Verify that the reagent was stored properly, and that the foil package was opened just prior to use.</p> <ol style="list-style-type: none"> 4. If the error still occurs, contact your local technical support.
E311 Microalbumin/ Creatinine Cartridge Error - Creatinine absorbance is too high	One of the 26 creatinine absorbance readings is too high. Possible cause: <ul style="list-style-type: none"> • cartridge exposed to excessive temperature or humidity 	<ol style="list-style-type: none"> 1. Discard the sample. 2. Acknowledge the error. The system is ready. 3. Repeat the test. <p>NOTE: Verify that the reagent was stored properly, and that the foil package was opened just prior to use.</p> <ol style="list-style-type: none"> 4. If the error still occurs, contact your local technical support.
E313 Microalbumin/ Creatinine Cartridge Error - high variability in absorbance readings	The Mean Squared Error calculated after the third order polynomial fit of the creatinine readings is too large. Possible cause: <ul style="list-style-type: none"> • cartridge exposed to excessive temperature or humidity 	<ol style="list-style-type: none"> 1. Discard the sample. 2. Acknowledge the error. 3. Repeat the test. <p>NOTE: Verify that the reagent was stored properly, and that the foil package was opened just prior to use.</p> <ol style="list-style-type: none"> 4. If the error still occurs, contact your local technical support.

Error Code	Description	Corrective Action
E315 Microalbumin normalization required	The Microalbumin Normalization was not performed or the Microalbumin Normalization Factor (MNF) was corrupted. Possible cause: <ul style="list-style-type: none"> • system not adjusted to run Microalbumin/ Creatinine test 	<ol style="list-style-type: none"> 1. Acknowledge the error. 2. If the error still occurs, contact your local technical support.
E316 Microalbumin normalization out of range	The Microalbumin Normalization Factor entered is outside of expected range. Possible causes: <ul style="list-style-type: none"> • normalization cartridge is not in proper position • normalization cartridge is dirty or defective 	<ol style="list-style-type: none"> 1. Acknowledge the error. 2. Verify that the cartridge was inserted completely into the system. 3. Repeat the test. 4. If the error still occurs, contact your local technical support.

8 File Management

You can manage the patient test data, control data, and system settings by exporting this data to a USB storage device, deleting, and restoring data as needed.

The system stores up to 4000 patient and control tests. When the DCA Vantage system reaches capacity, you must delete some test results to free up space. When the system is full, you cannot run any new tests. You can delete test results manually or set the system to automatically delete test results.

Exporting Patient Data



CAUTION

When you export data that contains patient information, it is your responsibility to comply with your local procedure on HIPAA regulations.

Use the Export Data screen to export patient test files to an external storage device.

1. At the Home screen, select **Recall**.
2. From the Recall menu, select **Patient Tests**.
3. From the Patient Tests screen, select **Export**.
4. Insert the storage device into the USB port.
5. To export the files, select **Next**.

The files are exported.

6. When the system directs you, remove the storage device from the USB port.

NOTE: When you export patient data, the result is a tab-delimited text file. The patient data is stored as `ExportedHbA1cPatient.txt` file for HbA_{1c}, and as `ExportedMicroalbuminCreatinine.txt` for Microalbumin/Creatinine. You can view and save these on your PC using a text editor or a spreadsheet program.

Saving Data and Settings

The Save Data and Settings screen instructs you to insert the storage device into the Universal Serial Bus (USB) port. The entire database is copied to the device.

1. At the Home screen, select **Menu**.
2. At the Menu screen, select **System Settings**.
3. At the System Settings menu, select **Additional Settings**.
4. At the Additional Settings menu, select **General**.
5. Select **Save Data and Settings**.
6. Insert a storage device into the USB port, then select **Next**.
When the system directs you, enter a password that will be used to protect the exported data and select **Next**.
The data and settings are saved.
7. Remove the storage device from the USB port.

Restoring Data

The Restore Data screen instructs you to insert the storage device with the saved data into the USB port. Restoring data replaces your current patient and control test data with the data from your storage device.

NOTE: Any existing data in the database is replaced by the data on the backup database. If the current database and the backup database versions are different, the backup fails.

1. At the Home screen, select **Menu**.
2. At the Menu screen, select **System Settings**.
3. At the System Settings menu, select **Additional Settings**.
4. At the Additional Settings menu, select **General**.
5. Select **Restore Data**.
6. To start the restoration, select **Next**.
7. Insert a storage device into the USB port, then select **Next**.
8. When the system directs you, enter the password that you used to protect the exported data and select **Next**.
The data is restored.
9. Remove the storage device from the USB port.

Restoring Settings

The Restore Settings screen instructs you to insert the storage device with the saved settings into the USB port. The restoring the system settings replaces your current system settings with the settings from your storage device.

NOTE: Any existing setting in the database is replaced by the settings on the backup database. If the current database and the backup database versions are different the backup fails.

1. At the Home screen, select **Menu**.
2. At the Menu screen, select **System Settings**.
3. At the System Settings menu, select **Additional Settings**.
4. At the Additional Settings menu, select **General**.
5. Select **Restore Settings**.
6. Select **Next**.
7. Insert the storage device into the USB port.
8. To start the restoration, select **Next**.
When the system directs you, enter a password that you used to protect the exported data and select **Next**.
The data is restored.
9. Remove the storage device from the USB port.

Deleting Data

In System Settings, you can set up whether you want the system to automatically delete test results when the maximum number is reached, or have the system warn you when the data storage is full. If you choose to have the system warn you, then you have to manually delete some test results to free up space.

Use the Delete Data screen to delete all the patient information that associates the patient with the test result, or both the patient information and test results.

1. At the Home screen, select **Menu**.
2. At the Menu screen, select **System Settings**.
3. At the System Settings menu, select **Additional Settings**.
4. At the Additional Settings menu, select **General**.
5. Select **Delete Data**.
 - a. To delete all of the patient information that associates the patient with the test result, select **Delete Patient Information**.
 - b. Select **Yes**.
All the patient information is deleted.
6. To delete patient information and test results, select **Delete All Data**.

7. Select **Yes**.

All patient information and test data is deleted.

9 Customizing the System

You can customize the analysis and reporting characteristics of your DCA Vantage system. You can specify the data, comments, and reminder schedules, for your lab. You can also schedule and change the configuration of control tests.

Setting Patient Test Options

Use the Patient Tests menu to access the screens that specify the data you enter with patient tests, and to view what factors control how some patient test results are calculated.

Setting Patient Data Entry

Use the Patient Data Entry screen to specify the data and comments you enter when running a patient test, and what data you enable only or require. Only the data you select as enabled displays. If you select required, you must enter a value for that specific data before you can exit the screen.

1. At the Home screen, select **Menu**.
2. Select **System Settings** from the Menu screen.
3. At the System Settings menu, select **Additional Settings**.
4. At the Additional Settings menu, select **Patient Tests**.
5. Select **Data Entry**.
6. Select **Enabled** then select **Required** (if the data is required) for each of the following options:
 - Sample ID
 - Patient ID
 - Last Name
 - First Name
 - Operator ID
 - Comment 1–8
7. To save the settings, select **Save**.

Setting Urine Creatinine Units

Use the Creatinine Units screen to set the units for creatinine results to either mg/dL or mmol/L.

1. At the Home screen, select **Menu**.
2. Select **System Settings** from the Menu screen.
3. At the System Settings menu, select **Additional Settings**.

4. At the Additional Settings menu, select **Patient Tests**.
5. Select **Urine Creatinine Units**.
6. Select one following unit options:
 - mg/dL
 - mmol/L
7. To save the creatinine unit setting, select **Save**.

Setting the HbA_{1c} Reference Range

Use the Reference Range screen to specify the upper and lower reference range values for HbA_{1c} results.

NOTE: You cannot set the lower limit higher than the upper limit, or allow a difference of less than 0.5% between the upper and lower limits.

1. At the Home screen, select **Menu**.
2. Select **System Settings**, from the Menu screen.
3. At the System Settings menu, select **Additional Settings**.
4. At the Additional Settings menu, select **Patient Tests**.
5. Select **Reference Range**.
6. Select **Set Range**.
7. Use the up and down arrows to adjust the upper and lower limits.

NOTE: To set the reference range to the default values, select **Reset Default Values**. This resets the Lower % to 4.0 and the Upper % to 6.0.

To save the HbA_{1c} reference range, select **Save**.

HbA_{1c} Testing and Results

The DCA Vantage system is qualified for specific reportable ranges, as indicated in the following table. If the HbA_{1c} value is less than the lower limit or greater than the upper limit, the instrument displays a warning message. Depending on the primary reporting unit configured, this message tells you when a reported value is less than or greater than the range for that unit.

The following table shows the Patient Test limits for each of the supported reporting units:

Reporting Unit	Lower Limit	Upper Limit
NGSP	2.5%	14.0%
JDS	2.2%	13.5%
mono-S	1.5%	12.7%
IFCC	4 mmol/mol	130 mmol/mol

Display, Print, and Transmit HbA_{1c} Reference Ranges

You can set up the Reference Ranges to print, display and transmit. This feature can be enabled or disabled. After enabling this feature, you can print, display, and transmit the sample data while the results display. To enable this feature, perform the following steps:

1. At the Home screen, select **Menu**.
2. Select **System Settings** from the Menu screen.
3. At the System Settings menu, select **Additional Settings**.
4. At the Additional Settings menu, select **Patient Tests**.
5. If required, enter your access code.
6. Select **Reference Range**.
The HbA_{1c} Reference Range Output screen displays.
7. Select **Enabled**.

If you want to disable this feature after it has been enabled, select **Disabled**.

Designating the Primary and Secondary HbA_{1c} Reporting Units

A supervisor (that is, a Level 1 operator) can designate the required primary, and optional secondary HbA_{1c} Reporting Units for displaying and printing using the following procedure:

1. At the Home screen, select **Menu**.
2. Select **System Settings**, from the Menu screen.
3. At the System Settings menu, select **Additional Settings**.
4. Select **HbA_{1c} Reporting Units**.
The access code screen displays.
5. Enter the access code with the keypad or external barcode reader.
6. Select **Enter**.
The HbA_{1c} Reporting Units screen displays.

7. Select the Primary Reporting units.
8. Select the optional Secondary Reporting units.
9. Select **Save**.

Values for NGSP, mono-S, and JDS are expressed in %.

The IFCC value is expressed as mmol/mol.

The following tables show the allowable reporting units selections on this screen:

- Table 6 on page 156 shows the reporting units settings available when Japanese mode is set to Off.
- Table 7 on page 156 shows the reporting units settings available only when Japanese mode is set to On.

Table 6 HbA_{1c} Reporting Units Settings, Japanese Mode Off

<i>Primary</i>	<i>Secondary</i>
IFCC	None
IFCC	NGSP
IFCC	mono-S
NGSP	None
NGSP	IFCC
NGSP	mono-S
mono-S	None
mono-S	IFCC
mono-S	NGSP

Table 7 HbA_{1c} Reporting Units Settings, Japanese Mode On

<i>Primary</i>	<i>Secondary</i>
NGSP	None
NGSP	JDS
NGSP	IFCC
JDS	None
JDS	NGSP
JDS	IFCC
IFCC	None
IFCC	NGSP

NOTE: When you select JDS, the display and printout show the units of the results as HbA_{1c}(JDS). If you select NGSP, the display and printout show the units of the results as HbA_{1c}(NGSP).

Setting User Corrections

You can adjust the slope and the offset for HbA_{1c} values, Albumin values, and Creatinine values.

Corrected and uncorrected results outside the operating range are reported the same way.

If results are within the operating range and a user correction is applied, the corrected results are reported with an asterisk (*).

When recalling saved data, the saved data displays as uncorrected if a correction is not set in the system. If a correction is set when the data is recalled, that correction is applied to the recalled data.

Setting the HbA_{1c} User Correction

Use the HbA_{1c} User Correction screen to adjust the slope and the offset for HbA_{1c} values.

1. At the Home screen, select **Menu**.
2. Select **System Settings** from the Menu screen.
3. At the System Settings menu, select **Additional Settings**.
4. Select **Patient Tests** from the Additional Settings menu.
5. Select **HbA1c User Correction**.
6. Change the slope, if needed:
 - a. Select **Edit**.
The HbA_{1c} Slope screen displays.
 - b. Enter the slope.
 - c. Select **Enter**.
The HbA_{1c} User Correction screen displays.
7. Change the offset, if needed:
 - a. Select **Edit**.
The HbA_{1c} Offset screen displays.
 - b. Enter the offset.
 - c. Select **Enter**.
The HbA_{1c} User Correction Screen displays.

To reset the settings to the default values:

- a. Select **Reset Default Values**.

This resets the slope to 1.000 and the offset to 0.0.

8. After completing the changes, select **Back**.
The Patient Tests screen displays.

Setting the Albumin User Correction

Use the Albumin User Correction screen to adjust the slope and the offset for Albumin values.

NOTE: Siemens recommends that you do not use a user defined correlation when you perform external proficiency testing. This can impact the results.

1. At the Home screen, select **Menu**.
2. Select **System Settings** from the Menu screen.
3. At the System Settings menu, select **Additional Settings**.
4. At the Additional Settings menu, select **Patient Tests**.
5. Select **Albumin User Correction**.
6. Change the slope, if needed:
 - a. Select **Edit**.
The Albumin Slope screen displays.
 - b. Enter the slope.
 - c. Select **Enter**.
The Albumin User Correction screen displays.
7. Change the offset, if needed:
 - a. Select **Edit**.
The Albumin Offset screen displays.
 - b. Enter the offset.
 - c. Select **Enter**.
The Albumin User Correction Screen displays.

To reset the settings to the default values:

- a. Select **Reset Default Values**.

This resets the slope to 1.000 and the offset to 0.0.

8. After completing the changes, select **Back**.
The Patient Tests screen displays.

Setting the Creatinine User Correction

Use the Creatinine User Correction screen to adjust the slope and the offset for creatinine values.

1. At the Home screen, select **Menu**.

2. Select **System Settings**, from the Menu screen.
3. At the System Settings menu, select **Additional Settings**.
4. At the Additional Settings menu, select **Patient Tests**.
5. Select **Creatinine User Correction**.
6. Change the slope, if needed:
 - a. Select **Edit**.
The Creatinine Slope screen displays.
 - b. Enter the slope.
 - c. Select **Enter**.
The Creatinine User Correction screen displays.
7. Change the offset, if needed:
 - a. Select **Edit**.
The Creatinine Offset screen displays.
 - b. Enter the offset.
 - c. Select **Enter**.
The Creatinine User Correction Screen displays.
8. To reset the settings to the default values, select **Reset Default Values**.
This resets the slope to 1.000 and the offset to 0.0.
9. Select **Back**.
The Patient Tests screen displays.

Setting the GFR Calculation

Use the GFR Calculation screen to turn the GFR Calculation on or off, and to select the unit of measurement for plasma creatinine.

1. At the Home screen, select **Menu**.
2. Select **System Settings** from the Menu screen.
3. At the System Settings menu, select **Additional Settings**.
4. At the Additional Settings menu, select **Patient Tests**.
5. Select **GFR Calculation**.
6. Select one of the following options under GFR Calculation:
 - Enabled
 - Disabled
7. Select one of the following units under Creatinine Units:
 - mg/dL
 - mmol/L
8. To save the GFR Calculation settings, select **Save**.

Setting the Patient Recall List Options

Use the Patient Recall List Options screen to set the search criteria for patient results, and how the results are displayed. You can search by either patient ID or last name.

1. At the Home screen, select **Menu**.
2. Select **System Settings** from the Menu screen.
3. At the System Settings menu, select **Additional Settings**.
4. At the Additional Settings menu, select **Patient Tests**.
5. At the Patient Tests menu, select **Patient Recall List Options**.
6. Select one of the following options:
 - Last Name
 - Patient ID
7. To save the settings, select **Save**.

Setting Patient and Control Test Delete Options

Use the Storage Mode screen to specify how to delete patient and control test data from the system. You can select to automatically delete tests based on a first in, first out basis, or you can manually delete a test.

1. At the Home screen, select **Menu**.
2. Select **System Settings**, from the Menu screen.
3. At the System Settings menu, select **Additional Settings**.
4. At the Additional Settings menu, select **General**.
5. Select **Storage Mode**.
6. To automatically delete patient and control test data on a first in, first out basis, select **Automatic Deletion (First In, First Out)**.
7. To manually delete patient and control test data, select **Manual Deletion**.
8. To save the storage mode, select **Save**.

Setting Control Test Options

Use the Control Test screen to perform the following tasks:

- specifying the data entered when a control test is run
- viewing the control test log and schedule
- modifying the control test reminder schedule

Setting Control Tests Data Entry

Use the Control Tests Data Entry screen to specify the data and comments you enter when you run a control test, and what data is required or optional. Only the data you select as optional displays. If you select *Required*, you have to enter a value for that specific data before you can exit the screen.

1. At the Home screen, select **Menu**.
2. Select **System Settings**, from the Menu screen.
3. At the System Settings menu, select **Additional Settings**.
4. Select **Control Tests**.
5. Select **Data Entry**.
The Control Sample Data Entry screen displays.
6. Select **Enabled** and select **Required** (if data must be entered) for each of the following options:
 - Operator ID
 - Comment 1–3
7. To save the settings, select **Save**.

Setting Control Test Reminders

Use the Control Test Reminders screen to access the Control Test Log, and to view or change the schedule for the control tests. The default setting is that none of the Control Test Reminders are selected. After you select the check box for a specific reminder, Schedule becomes active.

You must perform required control tests when they are scheduled. Patient test is disabled until the required control is performed and passed. You can run a control test prior to the scheduled time; however you are still reminded to run the test at the schedule time.

You can perform optional control tests when they are scheduled. Patient tests are not disabled when an optional control test is due.

1. At the Home screen, select **Menu**.
2. Select **System Settings** from the Menu screen.
3. At the System Settings menu, select **Additional Settings**.
4. Select **Control Tests**.
5. Select **Reminders**.
6. To set a control test reminder, select the check box.
The control test reminder is set and the schedule becomes active.
7. To view the schedule, select **Schedule**.
The reminder schedule displays.

8. To change the schedule to optional or required, select **Change**.
The Mode screen displays.
9. Select **Optional** or **Required**.
10. Select **Next**.
The Frequency screen displays.
11. Select one of the following options:
 - Daily
 - Weekly
 - Monthly
 - Custom
12. Select **Next**.
The Control Test Reminder Day screen displays.
13. Use the up and down arrows to select the day or date of the reminder.
14. Select **Next**.
The Control Test Reminder Time screen displays.
15. Use the up and down arrows to select the time of the reminder.
16. Select **Next**.
The Control Test Reminder Information screen displays.
17. Review the data, then select **Save**.
18. To return to the Control Test menu, select **Back**.

Performing Control Tests

You must perform control tests when they are scheduled. If a required control test is due, you must perform that test before you can run patient tests. If an optional control test is due, you can still run patient tests without performing the optional control test.

Control Test Limits

The DCA Vantage system is qualified for specific reportable ranges, as indicated in the following table. If the HbA_{1c} value is less than the lower limit or greater than the upper limit, the instrument displays a warning message. Depending on the primary reporting unit configured, this message tells you when a reported value is less than or greater than the range for that unit.

The following table lists the control test limits for each algorithm type:

Algorithm	Lower Limit	Upper Limit
NGSP	2.5%	16.0%
JDS	2.2%	15.4%

<i>Algorithm</i>	<i>Lower Limit</i>	<i>Upper Limit</i>
mono-S	1.5%	14.7%
IFCC	4 mmol/mol	151 mmol/mol

Setting a Test Lockout

Use the Test Lockout screen to prevent a user from performing patient tests when the current test type has a control test due. An authorized operator can turn off the Patient Test Lockout to unlock the system if a control test did not pass. Use the remote patient lockout function to perform a lockout from a remote computer via the network connection.

NOTE: You can disable the Remote Patient test Lockout setting from the system if you enter the Support ID.

1. At the Home screen, select **Menu**.
2. Select **System Settings**, from the Menu screen.
3. At the System Settings menu, select **Additional Settings**.
4. At the Additional Settings menu, select **General**.
5. Select **Test Lockout**.
6. To lockout patient test because of a control failure, select **Patient Test Lockout on Control Test Failure**.
7. To lockout patient tests from a remote computer, select **Remote Patient Test Lockout**.
8. To save the test lockout setting, select **Save**.

Setting General Options

Use the General Setting menu to access screens that configure the general settings. This determines what displays on the screen while a test is running. General settings include language, time, date, and sequence number options.

Setting the Language

Use the Language screen to change the language that displays on the system.

1. At the Home screen, select **Menu**.
2. Select **System Settings** from the Menu screen.
3. At the System Settings menu, select **Additional Settings**.
4. At the Additional Settings menu, select **General**.
5. Select **Language**.
6. Select the language that you want to display on the system.
7. To save the language selection, select **Save**.

Setting the Time Format and Time

Use the Time screen to select the time format as 12-hour or 24-hour and set the current time.

NOTE: We recommend that you manually adjust your system clock for daylight savings time in the spring and the fall.

1. At the Home screen, select **Menu**.
2. Select **System Settings**, from the Menu screen.
3. At the System Settings menu, select **Additional Settings**.
4. At the Additional Settings menu, select **General**.
5. Select **Time**.
6. Select a time format:
 - 12 hour
 - 24 hour
7. Use the up and down arrows to select the hour and the minutes.
8. Select **AM** or **PM**.

NOTE: You only have this option if you select a 12-hour time format.
9. To save the time setting, select **Save**.

Setting the Date Format and Current Date

Use the Date screen to set the date format and the current date.

1. At the Home screen, select **Menu**.
2. Select **System Settings** from the Menu screen.
3. At the System Settings menu, select **Additional Settings**.
4. At the Additional Settings menu, select **General**.
5. Select **Date**.
6. Select a date format:
 - MM/DD/YYYY
 - DD.MM.YYYY
 - YYYY.MM.DD
7. Use the up and down arrows to select the Month, Day, and Year.
8. To save the date format, select **Save**.

Setting the Sequence Number Options

Use the Sequence Number screen to specify whether the sequence number resets, and whether the sequence number displays.

1. At the Home screen, select **Menu**.

2. Select **System Settings**, from the Menu screen.
3. At the System Settings menu, select **Additional Settings**.
4. At the Additional Settings menu, select **General**.
5. Select **Sequence Number**.



CAUTION

If you are using a RAPIDComm® data management system, you must enable sequence numbers so that RAPIDComm can detect duplicate transmissions. Failure to do so can result in a patient result record being sent to the Laboratory or Hospital Information System more than once.

6. Select a sequence number reset:
 - Resets Daily – the sequence number is reset daily
 - Resets after 999 – the sequence number resets after it reaches 999
 - None – no sequence number is set
7. To save the sequence number setting, select **Save**.

Volume and Display

Use the System Settings menu to access screens to configure the sound volume and display contrast and brightness.

Setting the Sound Volume

Use the Sound Volume setting to set the volume of the audible alerts.

1. At the Home screen, select **Menu**.
2. Select **System Settings** from the Menu screen.
3. At the System menu, select **System Settings**.
4. Select **Sound Volume**.
5. Select one of the following options:
 - High
 - Medium
 - Low
 - Off
6. Select **Save**.
The sound volume is set.

Setting the System Display

Use the System Display screen to set the contrast of the color display.

1. At the Home screen, select **Menu**.
2. Select **System Settings**, from the Menu screen.
3. Select **Display**.
4. Use the up and down arrows to adjust the contrast of the color display.
5. Select **Save**.

The system display is set.

Viewing the Current System Settings

You can view the system settings including serial number, software version number, patient test settings, patient printed report type, control test settings, reminders, time format, and MAC address.

See *System Settings Report*, page 190 for a complete list of the contents of a full and a partial printed System Settings report.

Viewing and Printing a Partial System Settings Report

To print a partial System Settings Report, perform the following steps:

1. At the Home screen, select **Menu**.
2. Select **System Settings** from the Menu screen.
3. To view the partial Systems Settings Report, select **View Settings**.
The View Settings screen displays the current system settings.
4. To print the current system settings, select **Print**.

Printing a Full System Settings Report

To print a full System Settings Report, perform the following steps:

1. At the Home screen, select **Menu**.
2. Select **System Settings** from the Menu screen.
3. Select **Additional Settings** from the System Settings screen.
4. Select **Print**.

Customizing Printed Report Headers

You can optionally specify a 1- or 2-line header that appears on all printed reports. Each line can be up to 24 characters long.

1. At the Home screen, select **System Settings**.
2. At the System Settings menu, select **Additional Settings**.

3. At the Additional Settings menu, select **Printers**.
4. Select **Report Headers**.
5. Select **Line 1**.
 - a. Use the keypad to enter up to 24 characters for the first header line.
 - b. Select **Enter** to save this line.
6. If you want a second header line, select **Line 2**.
 - a. Use the keypad to enter up to 24 characters for the second header line.
 - b. Select **Enter** to save this line.
7. Select **Back** to return to the Printers screen.

NOTE: If you reset the printer defaults, the report headers are deleted.

Setting the Printed Patient Test Report Type

Specify whether you want full (long) or short (partial) reports by performing the following steps. For a summary of the contents of each report format, see *Patient Test Report Contents*, page 185:

1. At the Home screen, select **System Settings**.
2. At the System Settings menu, select **Additional Settings**.
3. At the Additional Settings menu, select **Printers**.
4. Select **Report Type**.
5. Select **Full Report** or **Short Report**.
6. Select **Save** to return to the Printers screen.

NOTE: Before attempting to print, make sure that at least one printer is enabled.

Appendix A: Safety Information

Protecting Yourself from Biohazards

This information summarizes the established guidelines for handling laboratory biohazards. This summary is based on the guidelines developed by the Centers for Disease Control, the Clinical and Laboratory Standards Institute, and the Occupational Safety and Health Administration.

Use this summary for general information only. It is not intended to replace or supplement your laboratory or hospital biohazard control procedures.

By definition, a biohazardous condition is a situation involving infectious agents biological in nature, such as the hepatitis B virus, the human immunodeficiency virus, and the tuberculosis bacterium. These infectious agents may be present in human blood and blood products and in other body fluids.

The following are the major sources of contamination when handling potentially infectious agents:

- needlesticks
- hand-to-mouth contact
- hand-to-eye contact
- direct contact with superficial cuts, open wounds, and other skin conditions that may permit absorption into subcutaneous skin layers
- splashes or aerosol contact with skin and eyes

To prevent accidental contamination in a clinical laboratory, strictly adhere to the following procedures:

- Wear gloves while servicing parts of the system that have contact with body fluids such as serum, plasma, urine, or whole blood.
- Wash your hands before going from a contaminated area to a noncontaminated area, or when you remove or change gloves.
- Perform procedures carefully to minimize aerosol formation.
- Wear facial protection when splatter or aerosol formation are possible.
- Wear personal protective equipment such as safety glasses, gloves, lab coats or aprons when working with possible biohazard contaminants.
- Keep your hands away from your face.
- Cover all superficial cuts and wounds before starting any work.
- Dispose of contaminated materials according to your laboratory's biohazard control procedures.
- Keep your work area disinfected.

- Disinfect tools and other items that have been near any part of the system sample path or waste area with 10% v/v bleach.
- Do not eat, drink, smoke, or apply cosmetics or contact lenses while in the laboratory.
- Do not mouth pipet any liquid, including water.
- Do not place tools or any other items in your mouth.
- Do not use the biohazard sink for personal cleaning such as rinsing coffee cups or washing hands.
- Do not recap, purposely bend, cut, break, remove from disposable syringes, or otherwise manipulate needles by hand. Needlestick injuries may result.

References

1. Centers for Disease Control. *Update: Universal precautions for prevention of transmission of human immunodeficiency virus, hepatitis B virus and other bloodborne pathogens in healthcare settings*. 1988. MMWR, 37:377–382, 387, 388.
2. Clinical and Laboratory Standards Institute (formerly NCCLS). *Protection of Laboratory Workers from Occupationally Acquired Infections; Approved Guideline - Third Edition*. Wayne, PA: Clinical and Laboratory Standards Institute; 2005. CLSI Document M29-A3. [ISBN 1-56238-567-4].
3. Federal Occupational Safety and Health Administration. Bloodborne Pathogens Standard. 29 CFR 1910. 1030.

External Barcode Reader Beam Safety

- Never look directly at the beam of a handheld barcode reader.
- Never point the scanner at another person.
- Do not look at the reflection of the beam from a shiny surface.

Electromagnetic Emissions Safety

When operating the DCA Vantage system, observe the following precautions:

- Do not use this system in close proximity to sources of strong electromagnetic radiation (for example, unshielded intentional RF sources), as these may interfere with the proper operation.
- Evaluate the electromagnetic environment prior to operating the system.

The system complies with the emission and immunity requirements described in IEC 61326-1 and IEC 61326-2-6 series.

Appendix B: Warranty and Support Information

Legal Information

To contact the legal representative for Siemens within the European community, contact the Siemens Authorized Representative. For service, contact your local technical support provider.

Siemens Authorized Representative

 Origin GB
Siemens Healthcare Diagnostics Inc.
511 Benedict Avenue
Tarrytown, NY 10591-5097 USA

 Siemens Healthcare Diagnostics
Manufacturing Ltd.
Chapel Lane
Swords, Co. Dublin, Ireland
siemens-healthineers.com/poc

Warranty Information

Installation Details

Please record the following information and keep this sheet in your laboratory for future reference.

Date of Installation: _____

Serial Number: _____

Manufacturer's Warranty

For warranty information, contact the local Siemens service provider.

Support Information

Contact your local technical support provider for assistance:

- if the error message continues to display after performing the steps described on the screen and in the Troubleshooting chapter
- if additional assistance is required concerning a system problem
- if the problem is beyond the scope of this manual
- if the problem cannot be solved and an system failure is apparent

Our local technical support providers are available to help you. Before calling, please complete the *Pre-service Checklist*, page 173. Make a photocopy of the checklist first. This information helps your local technical support provider to identify the probable cause of the problem.

IT Security

See the product's Security White Paper and MDS2 for additional information about specifications for software, hardware, network characteristics, and security controls. This technical information is not part of the operator guide, and is intended for the information technology or security professional. Security White Paper and MDS2 can be found at siemens-healthineers.com/poc or contact your local technical service provider.

Disposal of the Analyzer

The instrument must be treated as biological contaminated hazardous waste. Proper disposal of old instruments (including its plastic parts, electrical components) prevents potential negative consequences for the environment and human health. All electrical and electronic products and other components of the analyzer should be disposed of separately from the municipal waste system. Final disposal must be organized in a way that does not endanger waste handlers. As a rule, such equipment must be sterile before it is passed for final disposal. For more information about disposal of such product, please contact your city office, waste disposal service, or your local safety officer.

Technical Assistance

For customer support, please contact your local technical support provider or distributor.

siemens-healthineers.com/poc

According to EU regulation 2017/746, any serious incident that has occurred in relation to the device shall be reported to the manufacturer and the competent authority of the EU Member State in which the user and/or patient is established.

Training

This guide describes the proper use and operation of the system. System operators and administrators should familiarize themselves with the applicable sections in the manual prior to conducting testing to assure safe and effective use of the system. As training requirements for this device vary by country and region, make sure you follow any training in accordance with local, federal, or country laws and regulations. If you require further information about training in the use of this product, contact your local Siemens Healthineers representative.

Pre-service Checklist

Please record the following information and keep this sheet in the your laboratory for future reference.

Date of Installation: _____

Serial Number: _____

NOTE: After recording the information, make photocopies of this page to use before calling your local technical support provider.

1.	Does the fan come on when the system is turned On?	
	If NO:	
	<ul style="list-style-type: none"> Is the system firmly connected to a live AC electrical outlet? 	
2.	Is the touchscreen operating properly?	
	If NO:	
	<ul style="list-style-type: none"> Have you performed the touchscreen test? Have you calibrated the touchscreen? 	
3.	Does the system proceed properly while analyzing reagent cartridges?	
4.	What is the lot number of the reagent cartridges you are using?	
5.	Is the printer functioning properly? Are the appropriate messages and patient results being printed?	
	If NO:	
	<ul style="list-style-type: none"> Is the internal or an external printer turned ON? Is there paper in the printer? 	
	<ul style="list-style-type: none"> Have you performed the printer test? 	

6.	Are reasonable results being displayed and printed for the Quality Control and patient samples?	
	<p>If NO:</p> <ul style="list-style-type: none"> • Repeat the test. • If expected results are not recovered, repeat testing with new QC material. • If QC is out of range, record the QC lot and cartridge lot. • Consult your technical support provider. 	
7.	Is the system in the proper operating environment and location as described in Appendix E, <i>Specifications</i> ?	
8.	<p>What is the revision level of the system software?</p> <p>To find this information, select Help from the Home screen. The system displays the current software revision level.</p>	
9.	Are any error messages or warnings being displayed?	
	If so, list the error description and any numbers that display.	
10.	Have you performed the appropriate steps suggested on the display for the error being displayed?	
If an external device is being used:		
11.	Is the printer and/or host computer/LIS connected and turned On?	
12.	Have the correct parameters for transmission been selected through the Setup menus?	
13.	Is the external printer properly printing the test results?	
14.	Is the external barcode reader working properly?	

Appendix C: Orderable Supplies

Accessory Items

The accessory items available for the DCA Vantage system are listed below.

NOTE: Siemens has introduced new SMN part numbers for certain orderable supplies. The following tables show both the new SMN numbers and the earlier part numbers, where applicable.

Hemoglobin A_{1c}

<i>SMN Number</i>	<i>Part Number</i>	<i>Description</i>
10698915	5035C	DCA Reagent Kit
10311161	5068A	DCA Normal & Abnormal Control Kit
10888741	860044	HbA _{1c} Capillary Holder (strip of 10)

Microalbumin/Creatinine

<i>SMN Number</i>	<i>Part Number</i>	<i>Description</i>
10311480	6011A	DCA Reagent Kit
10325406	6012A	DCA Low & High Control Kit
10888739	877244	Microalbumin/Creatinine Capillary Holder

NOTE: Part numbers are subject to change without notice.

Replacement Parts

The replacement parts available for the DCA Vantage system are listed below.









<i>SNM Number</i>	<i>Part Number</i>	<i>Description</i>
10219275	036 282 46	NA Power Cord for System
10323672	060 487 20	Euro Power Cord for System
10323838	061 394 40	UK Power Cord for System
10282130	064 892 13	Filter Holder
10282132	064 892 48	Cartridge Return Spring
10320798	044 690 01	Fuse: T-1.25 A, Slow Blow; 250 volt
10337473	064 882 09	Cleaning Sticks (10)
10282131	064 892 21	Optical Test Cartridge













<i>SNM Number</i>	<i>Part Number</i>	<i>Description</i>
10318429	122521	Air Filter (2) Replacement Kit
10314709	011 501 95	Printer Paper (pack of 5)
10324219	063 527 80	Printer Paper Self Adhesive Stock (pack of 5)
10888741	860044	HbA _{1c} Capillary holder (pack of 10)
10888739	877244	Microalbumin/Creatinine Capillary holder
10282133	064 892 56	Multi-language Documentation CD



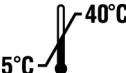









Appendix D: Symbols







System and Packaging

This section describes the symbols that can display in the system documentation, the exterior of the DCA Vantage system, or on the system packaging. The symbols on the system provide you with the location of certain components and with warnings for proper operation. The symbols on the system packaging provide you with other important information. For information on the symbols that can display on the DCA Vantage system reagent packaging and labeling, see the related assay instruction for use.

Symbol	Description
	<p>This symbol is used for both Warnings and Cautions.</p> <ul style="list-style-type: none"> • A Warning indicates the risk of personal injury or loss of life if operating procedures and practices are not correctly followed. • A Caution indicates the possibility of loss of data or damage to or destruction of equipment if operating procedures and practices are not strictly observed.
	This symbol identifies a hazardous area on the equipment.
	This symbol alerts you to a biohazard.
	This symbol indicates that the input electricity is alternating current.
	This symbol identifies the location of a power connector (power cord).
	This symbol identifies the location of a printer port.
	This symbol identifies the location of a barcode scanner or keyboard port.
	
	This symbol identifies the location of a serial port.





Symbol	Description
	This symbol identifies the location of an Ethernet port.
	This symbol identifies the location of the USB port.
	This symbol identifies the Laboratory Information System.
	This symbol identifies that this electronic information product does not contain any toxic or hazardous substances or elements, and is green and environmental. This system can be recycled after being discarded, and should not be casually discarded.
	This symbol indicates that the main power supply is on.
	This symbol indicates that the main power supply is off.
	This symbol indicates that the product has a temperature limitation. You need to store the product between 5–40°C.
	This symbol indicates an <i>in vitro</i> diagnostic device or an <i>in vitro</i> diagnostic medical device.
	This symbol indicates that you should consult instructions for use.
	This symbol indicates that the product is fragile and you need to handle it with care.
	This symbol indicates that you should keep the product dry.
	This symbol indicates that you should not spray any liquids in this area.















<i>Symbol</i>	<i>Description</i>
	This symbol indicates that you should keep the product away from sunlight and heat.
	This symbol indicates that the product is heavy, and should only be lifted by two or more persons.
	This symbol indicates a temperature hazard.
	This symbol cautions you to observe precautions for handling electrostatic sensitive devices, to avoid causing a hazard to the product.
	This symbol indicates that the system is type B equipment, which provides a particular degree of protection against electric shock.
	This symbol indicates to follow the appropriate procedures for disposal of electrical and electronic equipment.
	
	This symbol indicates the number used for ordering a part or product.
	This symbol indicates the serial number of a part or product.
Rev.	This symbol indicates the revision letter of a part or product.
	This symbol indicates the name and location of the product manufacturer.
	Device for near patient testing.
	This symbol indicates the date of manufacture of the product.
	This symbol indicates the manufacturer's authorized representative within the European community.

Symbol	Description
	This symbol indicates that the product or container should be oriented in the direction of the arrows.
	This symbol is indicates that the product or container contains recycled material.
	This symbol is intended to facilitate recycling of corrugated materials. The number is licensed in Germany and printed on corrugated shippers.
	This symbol indicates that the product complies with the applicable directives of the European Union.
	This symbol indicates that the instrument is safety tested by TUV SUD, a national certification body, for conformity to global markets, including Canada, US, and EU.
	This symbol indicates information about the fuse.

User Interface

This section describes the symbols that display on the system user interface.

	Home screen	Select this key to access the Home screen.
	System menu	Select this key to access the System menu.
	Calibrations and System Tests menu	Select this key to access the Calibrations or System Tests menu.
	Data Recall menu	Select this key to access the Data Recall menu.
	Help	Select this key to display a Help screen with information about the screen. Help is not available on all screens.

	Back	Select this key to change the display back to the previous screen in the series.
	Next	Select this key to display the next screen in the series.
	Up	Select this key to display the previous result or entry in descending order.
	Down	Select this key to display the next result or entry in descending order.
	OK, Save	Select this key to save any settings.
	Page Up	Select this key to display the previous page in descending order.
	Page Down	Select this key to display the next page in descending order.
	No, Cancel	Select this key to cancel an action.
	System Busy	This symbol indicates that the system is busy.
	Required Data Entry	This symbol indicates that the data is required.
	Add Comments	Select this key to add comments.
	Shut down System	Select this key to shut down the system.
	HbA _{1c} Blood Test	This symbol indicates a HbA _{1c} Blood test.
	Microalbumin/ Creatinine Urine Test	This symbol indicates a Microalbumin/Creatinine Urine test.



Quality
Control
Solution Test

This symbol indicates a Quality Control Solution test.

Appendix E: Specifications

System Specifications

This section summarizes the design specifications for the DCA Vantage system.

System Dimensions

<i>Dimension</i>	<i>Value</i>
Depth	27.7 cm (10.5 inches)
Height	25.4 cm (9.0 inches)
Width	28.7 cm (11.5 inches)
Weight	3.88 kg (9 lb.)

Environmental Specifications

<i>Specification</i>	<i>Value</i>
Ambient Operating Temperature	15° to 32°C (59° to 89.6°F) - Hemoglobin A _{1c} 18° to 30°C (64.4° to 86°F) - Microalbumin/ Creatinine
Analyzer Operating temperature	5° to 40°C (41° to 104°F)
Relative Humidity Indoor Use Only	10% to 90%, non-condensing, actively controlled
Altitude	up to 2000 meters (6000 feet)

Electrical Requirements

<i>Requirement</i>	<i>Value</i>
Electrical Rating	100-240 VAC 50/60 Hertz
Maximum Power Input	70 VA
Fuse Rating	1.25 Amperes

Electrical Precautions

Observe the following precautions when handling the system:

- Do not operate the system in the presence of a flammable anesthetic

mixture with air, O₂, or nitrous oxide. The risk of explosion exists if the system is operated in a potentially explosive environment.

- The system uses a grounded external power cord for connection to a grounded electrical outlet. If you use an adapter, ensure the grounding wire is properly connected to a permanent ground.

NOTE: This system was tested and complied with the limits for a Class B digital device, pursuant to part 15 of the FCC Rules. These limits are designed to provide reasonable protection against harmful interference in a residential installation. This system generalities, uses and can radiate radio frequency energy and, if not installed and used in accordance with the instructions in the *DCA Vantage Operator's Guide*, may cause harmful interference to radio communications.

There is no guarantee that interference will not occur in a particular installation. If this system does cause harmful interference to radio or television reception, which can be determined by turning the equipment off and on, try to correct the interference by one or more of the following measures:

- reorient or relocate the receiving antenna
- increase the separation between the system and the receiver
- connect the system into an outlet on a different circuit from the receiver
- consult a dealer or experienced radio/TV technician for help.

Safety Certifications

Refer to the DECLARATION OF CONFORMITY shipped with the DCA Vantage system.

Electromagnetic Compatibility (EMC)

Refer to the DECLARATION OF CONFORMITY shipped with the DCA Vantage system.

Reporting Results Calculations

The system generates calculations for HbA_{1c} and Glomerular Filtration Rate (GFR). You can customize the result reporting units according to your clinical practice or lab requirements.

Percent HbA_{1c} Calculation

The system calculates the values for HbA_{1c} for patient tests. To calculate the HbA_{1c} percentage, the system uses the concentration of HbA_{1c} divided by the total hemoglobin concentration.

$$\% \text{ HbA}_{1c} = (\text{HbA}_{1c} / \text{Total Hemoglobin}) \times 100$$

Dual Reporting Calculations – HbA_{1c} and IFCC Units

The dual reporting calculations convert the NGSP and mono-S percentages to IFCC mmol/mol. The source for the following calculations is <http://www.ngsp.org>.

DCA Vantage Mode	From IFCC to %HbA_{1c}	From %HbA_{1c} to IFCC mmol/mol
NGSP	$\text{NGSP} = (0.09148 \times \text{IFCC}) + 2.152$	$\text{IFCC} = (10.93 \times \text{NGSP}) - 23.50$

Glomerular Filtration Rate Calculation

The system calculates the values for Glomerular Filtration Rate (GFR) by using the following calculation. The source for the calculation is the National Kidney Foundation publication of 1999 MDRD study equation.

$$\text{GFR} = 186 \times (\text{plasma creatinine mg/dL})^{-1.154} \times (\text{patient age years})^{-0.203} \times (0.742 \text{ if female patient}) \times (1.210 \text{ if African-American patient})$$

Printed Reports

This section shows the contents of several of the printed reports that you can select. The Patient Test Report and the System Settings Report have both a long and a short format. These tables show the contents of each:

- *Patient Test Report Contents*, page 185
- *Patient Trend Graph Report Contents*, page 187 (Requires external printer)
- *Control Test Report*, page 188
- *System Settings Report*, page 190

Patient Test Report Contents

When an HbA_{1c} or Microalbumin/Creatinine patient test completes, the system displays the results on the screen. If you have enabled printing, the system can also print the results on the onboard or external printer, depending on the system settings. The short-form printout contains less data but prints faster. The displayed patient test results are the same as for the long-form printed results. The following table summarizes the information that the system prints for patient tests.

This table uses the following symbols:

- ✓ Always reported
- Omitted if not specified, disabled or deactivated, not calculated, default, or unedited
- (Blank) Not applicable

Value	HbA_{1c} Full Form	HbA_{1c} Short Form	A/C Full Form	A/C Short Form	Max. Field Length (Number of Characters)
DCA Vantage Product Logo	✓	✓	✓	✓	
Report Title	✓		✓		
Custom Heading 1 & 2	○	○	○	○	24 per line
Print Date	✓		✓		
Serial Number	✓	✓	✓	✓	
Test Date	✓	✓	✓	✓	
Sequence Number	○	○	○	○	
Cartridge Lot	✓		✓		
HbA_{1c} Primary Reporting Units	✓				
HbA_{1c} Secondary Reporting Units	○				
HbA_{1c} User Slope	○				
HbA_{1c} User Offset	○				
HbA_{1c} Primary Result	✓	✓			
HbA_{1c} Secondary Result	○				
HbA_{1c} Ref. Range	○				
Albumin User Slope			○		
Albumin User Offset			○		

<i>Value</i>	<i>HbA_{1c} Full Form</i>	<i>HbA_{1c} Short Form</i>	<i>A/C Full Form</i>	<i>A/C Short Form</i>	<i>Max. Field Length (Number of Characters)</i>
Creatinine User Slope			O		
Creatinine User Offset			O		
A/C			✓	✓	
Albumin			✓	✓	
Creatinine			✓	✓	
GFR	O		O		
Age	O		O		
Gender	O		O		
Race	O		O		
Plasma Creatinine	O		O		
Operator ID	O		O		16
Sample ID	O		O		13
Patient ID	O	O	O	O	24
Patient Last Name	O		O		15
Patient First Name	O		O		15
Comments 1–8	O		O		24
Test Edited	O	O	O	O	
Test Imported – SN	O	O	O	O	
----- (End of report)	✓	✓	✓	✓	

Patient Trend Graph Report Contents

When you issue a print request in a data recall function, you can generate a graph of patient results if you have an external printer attached to your system. The following table shows the contents of a patient trend graph report.

This table uses the following symbols:

- ✓ Always reported
- Omitted if not specified

<i>Value</i>	<i>Required?</i>
DCA Vantage Product Logo	✓
Report Title	✓
Custom Heading 1 & 2	○
Print Date	✓
Serial Number	✓
Patient ID	○
Patient Last Name	○
Patient First Name	○
Graph	○
Start Date	✓
End Date	✓
----- (End of report)	✓

Control Test Report

The Control Test Report prints Control Test results that are generated when you do the analysis. The system displays these results on the screen. You can generate a printed report when the results or the analysis are complete and when you issue print request during a Data Recall operation.

The following table summarizes the contents of a Siemens HbA_{1c} Control Test Report.

This table uses the following symbols:

- ✓ Always reported
- Omitted if not specified
- (Blank) Not applicable

<i>Value</i>	<i>HbA_{1c}</i>	<i>A/C</i>
DCA Vantage Product Logo	✓	✓
Report Title	✓	✓
Custom Heading 1 & 2	○	○
Print Date	✓	✓
Serial Number	✓	✓
Test Date	✓	✓
Sequence Number	○	○
Cartridge Lot	✓	✓
Control Lot	✓	✓
HbA _{1c} Primary Reporting Units	✓	
HbA _{1c} Secondary Reporting Units	○	
Level	✓	✓
Primary HbA _{1c} Result	✓	#
Secondary HbA _{1c} Result	○	
Albumin Result		✓
Creatinine Result		✓
Test Result Status (Passed or Failed)	✓	✓
HbA _{1c} Lower Bound	✓	
HbA _{1c} Upper Bound	✓	
Creatinine Lower Bound		✓
Creatinine Upper Bound		✓
Operator ID	○	○
Comment 1	○	○
Comment 2	○	○
Comment 3	○	○

<i>Value</i>	<i>HbA_{1c}</i>	<i>A/C</i>
Test Edited	O	O
Test Imported – S/N	O	O
----- (End of report)	✓	✓

System Settings Report

The following table summarizes the contents of a System Settings Report.

This table uses the following symbols:

- ✓ Always reported
- O Omitted if not specified

<i>Value</i>	<i>Full Report</i>	<i>Partial Report</i>
DCA Vantage Product Logo	✓	✓
Report Title (Full or Partial)	✓	✓
Custom Heading 1 & 2	O	O
Print Date	✓	✓
Serial Number	✓	✓
Software Version	✓	✓
Patient Test Data Entry	#	✓
Control Data Entry	#	✓
Sample ID	✓	#
Patient ID	✓	#
Last Name	✓	#
First Name	✓	#
Operator ID	✓	#
Comments 1–8	✓	#

Value	Full Report	Partial Report
Urine Creatinine Units	✓	#
HbA _{1c} Primary Reporting Units	✓	✓
HbA _{1c} Secondary Reporting Units	✓	✓
HbA _{1c} Reference Range Values	✓	✓
HbA _{1c} Reference Range Output	✓	✓
HbA _{1c} User Slope	✓	✓
HbA _{1c} User Offset	✓	✓
Albumin User Slope	✓	✓
Albumin User Offset	✓	✓
Creatinine User Slope	✓	✓
Creatinine User Offset	✓	✓
GFR Calculation	✓	✓
Patient Recall List Option	✓	#
Microalbumin Norm. Factor	✓	#
Operator ID	✓	#
Comments 1–3	✓	#
HbA _{1c} Normal	✓	#
HbA _{1c} Abnormal	✓	#
A/C Low	✓	#
A/C High	✓	#
Control Test Reminders	✓	✓
New Lot Reminder	✓	✓
Other Controls	✓	✓
Maintenance Reminders	✓	✓
Change Air Filter	✓	#

Value	Full Report	Partial Report
Clean Barcode Window	✓	#
Clean Cart. Compartment	✓	#
Run Optical PD Test	✓	#
Language	✓	#
Time Format	✓	✓
Date Format	✓	✓
Sequence Number	✓	✓
System Access	✓	✓
Remote Lockdown	✓	✓
Test Lockout	✓	✓
Settings Wizard	✓	#
Automatic Data Purging	✓	✓
Sound Volume	✓	✓
Onboard Printer	✓	✓
Onboard Printer Autoprint	✓	✓
External Printer	✓	✓
External Printer Autoprint	✓	✓
Patient Report	✓	✓
Custom Header 1 & 2	○	
External Barcode Reader	✓	✓
Symbology	✓	
Check Digit	✓	
Port	✓	✓
Protocol	✓	○
Serial Port	✓	

Value	Full Report	Partial Report
Baud Rate	✓	
Parity	✓	
Data Bits	✓	
Stop Bits	✓	
Ethernet Port	✓	
Host Name	✓	
IP Setting	✓	✓
IP Address	✓	
Port Number	✓	
Subnet Mask	✓	
DNS	✓	
Default Gateway	✓	
Remote Computer	✓	
MAC Address	✓	✓
End Date	✓	
----- (End of report)	✓	✓

Appendix F: External Barcode Reader

You can use the optional DCA Vantage system external handheld barcode reader, connected through the system's RS-232 interface, to enter and edit user information and to enter operator access codes. The software in the barcode reader automatically distinguishes between barcode formats.

Specifications

Barcode Formats

The DCA Vantage system's external barcode reader meets the requirements of ASTM E1466-92, *Standard Specification for Use of Barcodes on Specimen Tubes in the Clinical Laboratory* (available from ASTM International, 100 Barr Harbor Drive, West Conshohocken, PA 19428-2959 USA www.astm.org).

Barcode Symbols and Labels Specifications

The DCA Vantage system supports the barcode entry for the following patient and control data:

<i>Patient Data</i>	<i>Use</i>	<i>Control Data</i>	<i>Field Length (Characters)</i>
Patient First Name	Patient Tests, Recall Edit		1–15
Patient Last Name	Patient Tests, Recall Search, Recall Edit		1–15
Patient ID	Patient Tests, Recall Search, Recall Edit, Graph		1–24
Sample ID	Patient Tests, Recall Edit		1–13
Operator ID	Patient and Control Tests, Recall Control Search, Recall Patient/Control Edit NOTE: Except when the field is auto-populated in Restricted Plus or Fully Restricted modes	Operator ID	1–16
Comment 1	Patient and Control Tests, Recall Patient Search, Recall Patient/Control Edit	Comment 1	1–24
Comment 2, 3	Patient and Control Tests, Recall Patient/Control Edit	Comments 2,3	1–24

<i>Patient Data</i>	<i>Use</i>	<i>Control Data</i>	<i>Field Length (Characters)</i>
Comments 4–8	Patient Tests, Recall Edit		1–24

Barcode Symbolologies

The DCA Vantage system supports the following barcode symbolologies:

- Code 93
- Code 39 with and without check digit
- Code 128
- Codabar without check digit
- Interleaved 2 of 5 with and without check digit

Installing the External Barcode Reader

NOTE: Connect the barcode reader hardware to the DCA Vantage system before activating the software to use the external barcode reader.

1. Turn the system power off.
2. Connect the interface cable to the opening at the bottom of the handheld reader.
3. Connect the other end of the cable to the external barcode reader port at the back of the system.

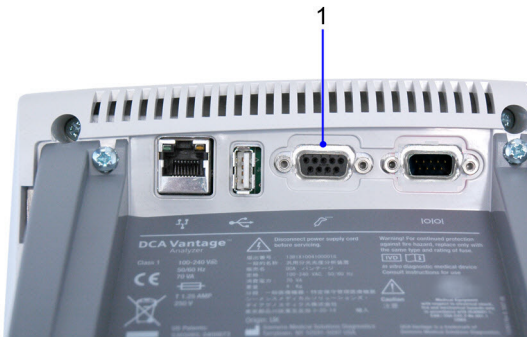

1. External Barcode Reader

Figure 45 External Barcode Reader Connection

4. Press in firmly until the connection is secure and you hear a gentle click.
5. Turn the system power on.
6. At the Home screen, select **Menu**.

7. Select **System Settings** from the Menu screen.
8. From the System Settings menu, select **Additional Settings**.
9. Select **External Barcode Reader**.
 - If using an Interleaved 2 of 5 barcode, select the I2of5 checkbox.
 - If using any other barcode, select the Other checkbox.
10. If you are using a check digit, select **Check Digit**.
11. To save the external barcode reader settings, select **Save**.

You can enable or disable a beep to sound after a successful barcode code scan. In Release 3.0, the beep is enabled by default. In earlier versions, the beep was disabled by default. Print these barcodes on a high-quality printer and scan to enable or disable the beep.

Beep after good code: Enable



Beep after good code: Disable



Disabling the External Barcode Reader

1. At the Home screen, select **Menu**.
2. Select **System Settings** from the Menu screen.
3. At the System Settings menu, select **Additional Settings**.
4. At the Additional Settings menu, select **External Barcode Reader**.
5. Select **Disabled**.
6. To save the external barcode reader settings, select **Save**.

Restoring the Barcode Reader default settings

1. Leave the barcode scanner connected to the DCA Vantage system.
2. Turn the system off from the Home screen.
3. Turn the system power switch to the off position.
4. Turn the system power switch to the on position to restart the system.

Testing the External Barcode Reader

Use the barcodes in this section to test each symbology with the barcode reader. Ensure that your external barcode reader has been correctly installed using the procedure in *Installing the External Barcode Reader*, page 196. Ensure that the barcoded labels used in your laboratory comply with the specifications given in this section.

NOTE: Do not scan the barcodes in the barcode-reader manufacturer's Quick Start Guide. The DCA Vantage system does not require this installation step.

1. At the Home screen, select **Menu**.
2. From the Menu screen, select **System Tests**.
3. Select **User System Tests**.
4. Select **External Barcode Reader**.
5. Select **Start**.
6. Follow the prompts to scan a barcode to complete the test.

You can test the function of the barcode scanner for each supported symbology by scanning the following barcodes or by printing them on a high-quality printer.

Code 39 Check Digit On



Code 39 Check Digit Off



I2of5 Check Digit On



I2of5 Check Digit Off



Code 128

Code 128



Code 93



CODA Bar

Codabar



Maintenance



CAUTION

Do not submerge the reader in water. The reader's housing is not water-tight.

Do not use laboratory wipes, such as Kimwipes, because they can scratch the window.

Do not use any type of solvent, other than recommended solvents, to clean the reader. Harsh chemicals can damage the finish or the window.

Clean the barcode reader window whenever it appears dirty or smeared:

1. Wipe the reader window with a soft cloth or facial tissue dampened with water or an ethanol solution.
2. If a detergent solution is used, rinse with a soft cloth or facial tissue dampened with water only.
3. Clean the plastic case using steps 1 and 2.

Troubleshooting

It is important that the labels be printed to the required specifications. Reading errors may occur if any of the following conditions exist:

- the narrow bar width is too small

- the barcode length too great
- the height too small
- the reader is held too far from the label
- the background reflection too high or low

If the reader is unable to consistently read your labels, apply a test label of the format being used to a new specimen tube and perform the Barcode Test. If the reader is able to read the test label, the quality of your labels may be suspect. If the test label cannot be read, the reader itself is suspect.

If you have problems that cannot be resolved, contact your local technical support provider.

Appendix G: Computer Interface (LIS)

General Information

You can connect the DCA Vantage system to a host computer or laboratory Information System (LIS). The DCA Vantage system supports a serial connection or an Ethernet connection between instrument and host. The serial interface is compatible with the EIA-232-D Specification. The Ethernet interface is established through the instrument's RJ45 internet connection.

Messages transferred from the DCA Vantage instrument to the host include:

- HbA_{1c} test result records
- Microalbumin/Creatinine test result records
- Filter Test Cartridge result records
- Control Test result records
- Cartridge Lot number
- System serial number

Messages transferred from the host to the DCA Vantage system include:

- Force Control remote commands
- Remote Lockout remote commands
- List of Operators
- QC test request

Ethernet Connections Using POCT1-A

The DCA Vantage system uses the POCT1-A standard to link to laboratory information systems. The POCT1-A standard automates transmission of information including date and time, result, patient ID, and Operator ID, to support a full electronic patient record. POCT1-A is the default Ethernet setting.

**CAUTION**

For software versions 4.0 and higher, the Patient Test Data Entry Setting for Patient ID is always both Enabled and Required. You cannot change this setting. However, you can change the value to another valid entry in the Patient_ID field.

POCT1-A2, the default Ethernet connection protocol, requires a value in the Patient_ID field in the patient observation test record. You cannot change this requirement.

The ASTM protocol allows a blank Patient_ID field. You may select ASTM as your Ethernet protocol. For detailed information, see the *DCA Vantage Analyzer Host Computer Communications Link* manual.

Ethernet Connections Using ASTM

The DCA Vantage system also supports the ASTM Specification E1381, Low-Level Protocol to Transfer Messages between Clinical Laboratory Instruments and Computer Systems. The system also supports the ASTM Specification E1394, Standard Specification for Transferring Information between Clinical Instruments and Computer Systems.

This appendix contains the specifications needed for the interface cable required.

For more information on connecting to an LIS, refer to the *DCA Vantage Analyzer Host Computer Communications Link* manual (Part Number 17306).

Serial Connection

The serial transmission between the system and the host is established through the system's serial port using a serial cable. The mechanical and electrical connection for serial binary data bit transmission between system and computer system is described in the serial physical layer. The DCA Vantage system implements and complies with the serial physical layer defined in the ASTM 1381 standard. For more information about this standard, refer to the standard.

Serial cable pin assignments and hardware handshaking are described in the following sections.

Architecture

The basic architecture is point-to-point communications between LIS and the DCA Vantage system.

Hardware Link

The hardware link consists of serial asynchronous (RS-232) interface. Communication is normally full duplex at one of the following user-selected baud rates:

- 19,200
- 9600
- 4800
- 2400

The system interface port is equipped with a 9-pin, D-type, male connector.

The systems are considered to be Data terminal Equipment (DTE). The signal lines that are supported are listed below.

Signal Line		Pin Number	Type
Data Carrier Detect (not used)	DCD	Pin 1	Control
Received Data	RD	Pin 2	Data
Transmitted Data	TD	Pin 3	Data
Data Terminal Ready (not used)	DTR	Pin 4	Control
Signal Ground	G	Pin 5	Ground
Data Set Ready (not used)	DSR	Pin 6	Control
Request to Send (not used)	RTS	Pin 7	Control
Clear to Send (not used)	CTS	Pin 8	Control
Ring Indicator (not used)	RI	Pin 9	Control

Character Format

You can select the following character format options when you select the LIS communication parameters in setup at the DCA Vantage system.

Option	Selection
data bits	7 bits, 8 bits
parity	odd, even, none

The stop bits are set to 1.

Ethernet Connection

TCP/IP transmission between the system and the host is established through the system's Ethernet network adapter using an RJ45 connector. The DCA Vantage system only supports the system connecting to the host. The host has to listen for connections on the TCP/IP port and needs to accept the connection when the system tries to connect.

To connect from the Ethernet port to a network, use a standard straight-through CAT 5 cable. To connect directly to a PC, use a crossover CAT 5 cable.

Displaying and Printing the MAC address

You can display the MAC address with the Factory Settings option and the View Settings screen. You can also print the MAC address from the View Setting screen.

To view or print the MAC Address with the View Settings option:

1. At the Home screen, select **Menu**.
2. Select **System Settings**.
3. Select **View Settings**.

The View Settings screen displays the current settings, which includes the MAC address.

To print the current settings, select **Print**.

Automatically Sending Data to an LIS

When you have enabled communications with an LIS, you can configure the system to automatically send all patient and control test results to the LIS as soon as the test result has completed, or as soon as you have finished entering or modifying patient demographic data.

NOTE: Auto Send does not apply to recalled patient and control test results.

The following conditions apply:

- Auto Send must be enabled.
- Communications must be enabled.
- A remote computer system (LIS) must be configured.

If you change the demographic fields, the system resends the test results when you return to the test results screen. The LIS should discard the first transmission and use only the modified version.

To enable Auto Send, perform the following procedure:

1. From the Home screen, select **Menu > System Settings > Additional Settings > Connectivity**.

2. Select the type of connection, **Ethernet** or **Serial**, and the protocol, **ASTM** or **POCT1A**.
3. To enable Auto Send, select the **Automatically Send** check box.
This selection is disabled by default.
To enable manually sending selected results, clear this check box.
4. Select **Configure** to set up the Ethernet or Serial port connection.
NOTE:At this stage, the system does not verify whether a connection exists.
5. Continue configuring the Ethernet or Serial connection parameters.
6. When finished, select **Save**.

The Auto Send setting is included in the backup and restore data so an administrator can copy the settings from one DCA system to another.

Transmission Status

The system displays the status of the transmission on the test result screen when communications are enabled, so that you know whether the LIS has received the transmission.

The transmission status can be one of the following:

- **Not Sent:** The message has not been transmitted to the LIS.
- **Sending:** Transmission is in process, but the system has not received acknowledgement from the LIS. The connection might have gone down either during or after the attempted transmission, and the connection has not been restored.
For the Ethernet ASTM protocol, the system tries again to transmit the results if the connection is restored within 72 hours of the most recent successful transmission. For the POCT1-A protocol, no time limit exists for retries.
- **Received:** The message was sent to the LIS, and the LIS has acknowledged receipt of the message.
- **Failed:** The LIS did not receive the message, or the LIS did not acknowledge the receipt of the message.
 - For a serial connection using the ASTM protocol, the test result has failed to be received by the LIS on the first attempt to transmit.
 - For an Ethernet connection using the ASTM protocol, 72 hours have passed since the most recent manual-send or auto-send after a good connection went down, and the test result has failed to be received by the LIS on subsequent attempts to transmit.
- **Unknown:** Only for test results created on Version 2.0 and upgraded directly to version 4.0 or greater. Not for live tests.

Recovery from a Failed Ethernet Connection

If the Ethernet connection to the LIS fails (goes down) and is subsequently restored, the system tries to retransmit only those patient or control test results that have a transmission status of Sending. When the transmission succeeds, the transmission status is updated accordingly.

If this is an ASTM connection, a transmission is considered to be failed if 72 hours have passed since the most recent transmission after a good connection went down, and the LIS did not receive the message on subsequent attempts to transmit it.

Appendix H: Glossary

Hardware Terms

The following table defines hardware terms that are commonly used on the DCA Vantage system:

Term	Definition
Air Filter	The filter in front of the cooling fan that keeps the system cool.
Air Vent(s)	The openings that allow air to enter and exit the system for cooling.
Battery	Provides power to the system during shutdown to avoid database corruption when the power switch is turned off.
Cartridge	The reagent cartridges that are inserted into the system to perform HbA _{1c} and Microalbumin/Creatinine tests.
Display	The LCD that displays the graphical software user interface.
Ethernet Connector Port	The connector port where a network Ethernet cable is inserted.
External Barcode Reader	An optional external barcode scanner that is connected to a port on the DCA product. Used to enter data into the DCA Vantage system.
External Printer	An optional printer that is connected to the USB connector port on the DCA product. Used to print reports.
Onboard Barcode Reader	The barcode scanner used to scan barcodes on DCA Reagent Cartridges and Cards.
Onboard Printer	The integral roll printer.
Onboard Printer Cover	The portion of the DCA system case that opens and closes to cover the onboard printer.
Power Switch	The switch that turns the system on and off.
Power Cord	The cord that connects the system to an electrical outlet.
Printer Paper Roll	The roll of printer paper the user inserts into the onboard printer.
Serial Connector	A connector used to transferred data between the DCA Vantage system and an LIS or computer.
Speaker	The device that enables the system to emit audio alerts.
System	The DCA Vantage product.

Term	Definition
System Door	The door which covers the opening where reagent cartridges are inserted into the optical system.
Touchscreen	The LCD display overlay which enables users to “touch” or “press” controls on the display.
USB Connector Port	The connector ports where Universal Serial Bus (USB) devices are inserted.

Software Terms

The following table defines hardware terms that are commonly used on the DCA Vantage system:

Term	Definition
Operator	An operator who has been assigned an access code and privileges on the DCA system.
Alert Message	A message that conveys information about the DCA system to the user.
Alphanumeric	Data comprised of alphabetic and numeric characters.
Audio Alert	Sounds emitted by the DCA system to draw the operators attention to the system.
Cancel	To end a sequence or operation.
Cartridge	The HbA _{1c} , Microalbumin/Creatinine, or Optical Test cartridges that are inserted into the system to perform a test.
Comment	An operator entered notation associated with a test result.
Control	Objects displayed on the software UI that the user can manipulate. Buttons, checkboxes, and radio buttons are examples of controls.
Countdown	A numeric display that indicates the amount of time left in an operation.
Data Entry	The act of entering data such as a patient or Operator ID into the DCA system.
Data Entry Box	A software UI object which displays data that is entered by the operator.
Diagnostic Screen	A software UI screen that enables the operator to perform a system diagnostic test when troubleshooting the DCA system.
Disabled	The state when a software UI control, such as a button, is not available to be “touched” or “pressed” by an operator.

Term	Definition
Drift Max	Drift Max is the difference between the maximum and minimum light transmittance values from the reading used to calculate the Mean Transmittance during the optical test. There are no set limits for Drift Max.
Enabled	The state when a software UI control, such as a button, is available to be “touched” or “pressed” by an operator.
Error	An system event that prevents the system from operating as desired.
Error Code	A number display by the system to communicate the occurrence of an error to the operator.
Export	To copy data off of a DCA system to a removable data storage device.
Help	Information presented to the operator to assist them with the completion of a task or operation.
Help Screen	The screen used to display help information to the operator.
Home Screen	The software UI screen operators encounter when the DCA system start up has completed. All software UI navigation begins from the Home screen.
Icon	An image used to label a control.
Import	To copy data to a DCA system from a removable data storage device.
Maintenance	The area of the software user interface where users can perform and/or record DCA system maintenance tasks.
Menu Screen	A software UI screen that displays buttons to the operator to allow them to choose an action.
Notifications Message	A message that conveys information about the DCA system to the user while on the Home UI screen.
Navigation	The act of moving between the screen which comprise the DCA Vantage software user interface.
Navigation Button	A software UI button control that when “touched” or “pressed” brings the operator to a different software UI screen.
Parity	A serial communication setting.
Ready	The DCA Vantage system state when the system is available to perform tests.
Recall	To access data such as test results stored on the DCA Vantage system.

Term	Definition
Restore	The act of copying data back onto a DCA Vantage system to restore it.
Required Entry	A sample data entry box that must have data entered into it during a test sequence.
Screen	The software “windows” that fill the entire display area which contain the controls the operators manipulate when operating the DCA system. The DCA Vantage system software user interface is comprised of individual screens.
Screen Title	A text label that typically appears in the upper, left corner of a screen which serves as a label for that screen.
Settings	The area of the software user interface where users can configure the DCA Vantage system.
Settings Screen	A software UI screen which enables the operator to adjust or configure some aspect of the DCA Vantage system.
Sound Volume	The software UI screen where the operator can adjust the volume level for the DCA Vantage system onboard sound which emits audio alerts.
Test Result	Measured reportable values displayed to the operator at the end of a test sequence.
Test Sequence	A series of software UI screens that guides the operator through the tasks required to perform a test on a sample.
Title Bar	The area along the top of UI screens where the location icon and title appear along with the time and date display.

Acronyms

The following table defines Acronyms that are commonly used on the DCA Vantage system:

Acronym	Full Title
A/C	Albumin/Creatinine
ASTM	American Society for Testing and Measurement
ASTM E 1381	ASTM Specification for a low level protocol for transferring messages between clinical laboratory instruments and computer systems
ASTM E 1394	ASTM Specification for a protocol for transferring messages between clinical laboratory instruments and computer systems
DHCP	Dynamic Host Configuration Protocol

<i>Acronym</i>	<i>Full Title</i>
DNS	Domain Name Server
Drift T	Drift Transmittance, the average drift in optical transmittance within the 5-minute Optical Test time
GFR	Glomerular Filtration Rate
GHb	Glycated Hemoglobin
I2of5	Interleaved 2 of 5 barcode
IP	Internet Protocol
LIS	Laboratory Information System
MNF	Microalbumin Normalization Factor
Mean A	Mean Average
Mean T	Mean Transmittance
NGSP	National Glycohemoglobin Standardization Program
P	Precision
PD	Precision Drift
POCT1A	Point of Care Testing 1A protocol for transferring messages between clinical laboratory instruments and computer systems
QC	Quality Control
SN	Serial Number
SD	Standard Deviation
S/R	Signal to Reference Ratio

Revision History

06489264 Rev. L

Chapter/Appendix	Description of Change
Table of contents	Added headings “Summary and Explanation”, “Materials Provided”, “Special Materials Required (Not Provided)”, “IT Security”, “Disposal of the Analyzer”, “Technical Assistance”, and “Training”.
Overview	Added IVD symbol in section “Intended Use”. Added section “Summary and Explanation”.
Installation	Added electromagnetic caution statement in section “Hardware Installation”.
Operating the System	Added section “Materials Provided” and “Special Materials Required (Not Provided)”. Added warning statement about cartridge holder heater plates in section “Removing the Reagent Cartridge”.
Appendix B: Warranty and Support Information	Added sections “Disposal of the Analyzer”, “IT Security”, and “Training”. Updated section heading “Technical Assistance” and added information about adverse incident to the user in that section.
Appendix C: Orderable Supplies	Updated reference number for DCA Reagent Kit in section “Accessory items”.
Appendix D: Symbols	Updated “Catalog number” and “Serial number” symbols. Added symbol “Device for near patient testing” with the description.
*	Updated web address to “siemens-healthineers.com/poc” in EC-REP.

* Indicates the changes are common and not included in any particular sections of this Operator’s Guide.

Index

A

- Air Filter
 - changing 105
- Albumin user correction
 - setting 158
- ASTM 1381 standard 202
- Auto Send test results to LIS 37, 204
- Automatic IP address 35

B

- Barcode Reader
 - beep 197
 - clean external 199
 - defaulting external 197
 - disabling external reader 197
 - installing external 196
 - testing external 197
 - troubleshooting external 199
- Barcode Window
 - cleaning 98
- Baud Rate
 - serial port 203

C

- Calculation
 - dual reporting, HbA1c and IFCC
 - units 185
 - GFR 185
 - percent HbA1c 184
 - results, reporting 184
- Calibrating
 - HbA1c 85
 - Microalbumin/Creatinine 87
- Calibration
 - overview 85
 - printing confirmation 85
 - viewing data 88
- Cancelling Tests 59
- Capillary
 - filling from finger stick 50
 - filling from venipuncture 50
 - inserting 53
- Cartridge Compartment
 - cleaning 100
- Caution

- electromagnetic 25
- Changing the air filter 105
- Cleaning
 - barcode window 98
 - cartridge compartment 100
 - exterior 98
 - external barcode reader 199
 - general 97
- Connections
 - overview 15
- Control Test
 - deleting 160
 - setting reminders 161
- Controls, running 92
- Conventions, text and symbol 12
- Creatinine user correction, setting 158
- Customer Support 171

D

- Data
 - deleting 151
 - exporting 149
 - restoring 151
 - saving 150
- Data Bits, LIS 203
- Date, setting 164
- Default Gateway 36
- Disposal of the Analyzer 172
- Domain Name 36
- Dual reporting calculations, HbA1c and IFCC units 185
- Dual Reporting Units
 - HbA1c 62
 - primary and secondary 62

E

- Error Codes 131
- Ethernet Port 34
- Events Notification 18
- Exporting data 149
- External Barcode Reader
 - installing 29
 - testing 197
- External Printer 30

F

- File Management 149

G

- GFR

- configuring 82
- setting the calculation 159
- Glomerular filtration rate
- calculation 185
- Graphs
 - HbA1c results 80
- H**
- Hardware, overview 14
- HbA1c and IFCC units, dual reporting
- Calculations 185
- HbA1c Reference Range, setting 154
- HbA1c Test
 - performing 48
 - preparing controls 48
 - preparing patient samples 48
 - results 59
- HbA1c user correction
 - setting 157
- Help, menu 18
- Home Screen, overview 18
- Host computer, connection 201
- Host Name 35
- I**
- I2of5 197
- IFCC 62
- IFCC and HbA1c units, dual reporting
- calculations 185
- Installation
 - Environmental requirements 183
 - External Barcode Reader 196
 - hardware 29
 - loading printer paper 31
 - power cord 28
 - system 25
 - unpacking 25
- Interleaved 2 of 5 197
- IP address 35
- IT Security
 - Security White Paper 172
- J**
- Japanese Mode 156
- L**
- Laboratory Information System (LIS)
 - connection 201
- Language, setting 163
- LIS

- connection 201
- RS-232 203
- M**
- MAC address 166, 204
- Maintenance
 - log 121
 - reminders 119
 - status 119
- Manually send results 37, 205
- Memory 15
- Microalbumin/Creatinine Test
 - performing 64
 - preparing 64
 - results 73
 - sequences 64
- N**
- NGSP 62
- O**
- Onboard Printer 30
- Operator ID
 - deleting 45
 - editing 44
- Optical Test 32
- P**
- Parity
 - LIS 203
- Parts
 - included with the system 25
 - replacement 175
- Patient Data Entry, setting 153
- Patient Tests
 - deleting data 160
 - graphs 80, 83
 - recall menu 77
 - recalling 77
 - reports 82
 - setting recall options 160
 - view last 10 77
 - viewing results 80
- Percent HbA1c calculation 184
- Port Number 36
- Power
 - connections 15
 - power save 17
- Power Cord 28
- Pre-service checklist 27

- Primary Reporting Units 62
- Printer
 - defaulting 31
 - loading paper 113
 - reset 31
 - selecting 81
- Printer paper, loading 113
- Q**
- Quality Control
 - overview 89
 - reminders 94
 - troubleshooting 93
- R**
- Ranges and References, reporting 59
- RAPIDComm sequence number requirement 165
- Reagent Cartridge
 - inserting 71
 - inserting into capillary holder 53
 - remove 75
 - removing 62
 - scanning 54, 70
- Recall, setting patient list options 160
- Reference Range
 - HbA1c 154
 - transmitting 155
- References, reporting 59
- Reminders, control test 161
- Remote Computer 36
- Report header setup 31
- Report type setup 31
- Reporting ranges 59
- Reporting units, setting primary and secondary 155
- Results
 - automatically sending 37, 204
 - manually sending 37, 205
- Results calculations, reporting 184
- RS-232 203
- S**
- Screen Components 17
- Secondary Reporting Units 62
- Send test results automatically to LIS 37, 204
- Sequence Number, RAPIDComm requirement 165
- Sequence Number, setting 164
- Serial Connections
 - installation 32
- Serial number 166
 - locating 27
- Serial Port 33
 - baud rate 33
 - parity 33
 - reset to default 34
 - stop bits 34
- Set
 - Albumin user correction 158
 - Creatinine user correction 158
 - date 164
 - GFR calculation 159
 - HbA1c Reference Range 154
 - HbA1c user correction 157
 - language 163
 - Sequence Number 164
 - system display 166
 - time 164
 - Urine Creatinine Units 153
 - user corrections 157
- Settings
 - restoring 151
 - saving 150
- Software
 - installing 38
 - overview 17
 - upgrading 38
 - version 166
- Specifications 183
- Start up tests 31
- Static IP address 35
- Subnet Mask 36
- Summary and explanation
 - human blood 13
- Supplies 175
- Symbols 177
- System display, setting 166
- System installation 25
- System settings wizard 32
- System settings, viewing 166
- System tests 110
- T**
- Technical Assistance

- EU Member State 172
- Test Lockout 162
- Test results, Microalbumin/
Creatinine 73
- Test, optical 32
- Tests
 - cancelling 59
 - system start up 31
- Time, setting 164
- Touch Screen
 - calibrating 112
 - damage 14
- Training
 - country laws and regulations 172
- Troubleshooting 123, 131
 - barcode reader, external 199
 - contacting customer support 171
 - preservice checklist 173
 - quality control 93

U

- Unpacking the system 25
- Urine Creatinine Units
 - setting 153
- USB 15
- User Corrections
 - setting 157
- User corrections
 - Albumin 158
 - Creatinine 158
 - HbA1c 157
- User interface symbols 177
- User system test 111, 112

W

- Warranty
 - information to record 27
- Warranty and support information 171
- Wizard, system settings 32