



Driving efficiency and productivity with standard pack solutions

2/2018

Presource Products and Services
Standard Pack Solutions

We offer custom and standard kits across all procedural areas:

Some procedures benefit from a standard kit, and more robust procedures need the flexibility and customization of a custom kit.

Our team works with you to evaluate your current practices and determine the best mix of kits to meet your needs.



Operating Room



Cath Lab



Interventional Radiology Lab



Endoscopy and GI Suite



Emergency Room



Women's Health



Nursing floors

Cardinal Health™ Presource Products and Services is the provider of low cost, high-quality kitting solutions to help improve your cost effectiveness and ability to serve patients. We offer custom and standard kits to best meet your needs. Our standard kits contain the core components needed for common surgeries providing savings and efficiencies when compared to purchasing, managing and picking items separately for your cases. With Presource® standard packs, you can count on high-quality items to be used in your procedures, promoting a safe and consistent standard of care. The result is a more efficient supply chain with increased staff satisfaction and safety, and more time for patient care.

Our promise: We go above and beyond to help you reduce costs and deliver high quality care.

How you benefit from a standard procedure pack program:

- Increased efficiencies and cost savings opportunities through practice and process changes
- Product standardization
- Supply consolidation
- Improved inventory management

Next-generation Presource® kits provide solutions to help you focus on what matters most—your patients.



Quality

High-quality kits and solutions to enable you to focus on what matters most—your patients.



Cost Effective

Standardization assessments and solutions designed to help you cut costs from the system.

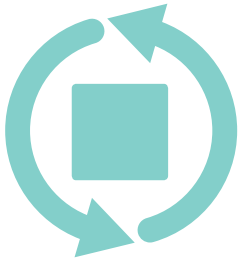

Predictable

A reliable and simple approach to pricing. Online access to your pricing, inventory and kitting program.

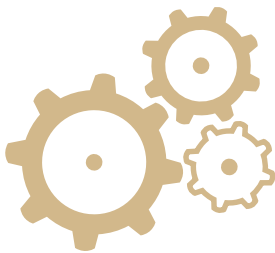

Innovative

New approaches to help you respond to the changing healthcare environment.

For more information, contact your Cardinal Health sales representative, call 1.800.964.5227 or email PresourceSolutions@cardinalhealth.com.

Presource Products and Services

Presource Products and Services is the provider of low-cost, high-quality Presource® kitting solutions serving integrated healthcare providers across the continuum of care with innovative products and services that improve their cost effectiveness and their ability to serve patients.



Contents

Admission and Amenity Kits

Admission Kits	6-7
Amenity Kits	8
Baby Care Kits	9
Better Stay Kit	10
Carafes	11
Denture Kit, Mouthcare Kits	12
Delivery Kits	13
Fall Prevention Kits	14
Maternity Kits, Maternity Briefs and Pad Kits	15-16

Anesthesia Kits

Standard Anesthesia Circuit Kits	17
--	----

Burn Kits

Burn Dressings	18
----------------------	----

Cath Lab Kits

Cardiac Cath Kits	19
Cath Angio Kit	20
Cath Lab Plus Kit	20
Cath Lab Plus with ChloraPrep® Kit	21
Pacemaker Kit	21

Diagnostic Procedure Trays

Diagnostic Procedures

Lumbar Puncture	22-24
Myelogram	25
Arthrogram	26
Amniocentesis	27

Acute Drainage

Paracentesis, Thoracentesis	28-33
Peritoneal Lavage	34

Biopsy

Bone Marrow Biopsy	35-43
Soft Tissue Biopsy	44-45
Basic	46
Paracervical/Pudendal Block	47

Gastroenterology Endoscopy Kits

Endoscopy Kits

Endo Scope Clean and Setup Kits	48
---------------------------------------	----

Minor Procedure Trays

Debridement Trays	49
Incision and Drainage Trays	50

Instruments

All Purpose Instrument Trays	51
Single, Sterile	52

Laceration Trays

One-Compartment Tray	53-56
Two-Compartment Tray	53, 57
Three-Compartment Tray	53, 58-60
Laceration Tray with Prep	53, 60-61

Minor Procedure Trays

Respiratory Care Trays

Chest Tube Insertion Tray	62
Tracheostomy, Tracheotomy Trays	62-63

Skin Prep Trays

Dry Prep	64-66
Wet Prep	67-71
Suture Removal Trays	72-74

OR Accessories

Electrosurgical Supplies	75
Equipment Covers	75-77
Esmark Bandages	78
Insufflation Tubing	78
Lap Sponges	78
Light Handle Covers	79
Medication Labels	79
Miscellaneous	80
Needle Counters	81
OR Towels	82
Skin and Utility Markers	83
Vessel Loops	83
OR Plastics	83
OR Setup and Basin Kits	84-88

OR Cleanup/Room Turnover Kits

OR Cleanup/Procedure Kits	89-90
---------------------------------	-------

Pain Management

Standard Kits	91-93
---------------------	-------

Personal Protection Equipment

Chemotherapy Kit	94
PPE Kits	95

Standard Surgical Kits

ENT

Head and Neck I, Head and Neck II	96
Nasal and Sinus, Nosebleed	97
T&A I, T&A II	98

General Surgery

Laparoscopy	99-100
Laparotomy	101
Minor Procedure	102
Universal, Universal Pack	102

Neurosurgery

Laminectomy I, Laminectomy II	103
Neurosurgery	104

Ophthalmic

Orthopedics	104
-------------------	-----

Orthopedics

Arthroscopy, Arthroscopy Knee	105-106
Basic Ortho	107
Extremity – Hand, Leg Fracture, Major and Upper	108-111

Standard Surgical Kits

Orthopedics, continued

Hip – Fracture, Setup and Total Hip	112-113
Knee and Ankle, Total Knee	114-115
Shoulder	116

Plastics

Facial	117
Oculoplastic	117

Podiatry

Podiatry I, Podiatry II	118
-------------------------------	-----

Urology

Cysto	119
TUR I, TUR II	119

Women's Health

Breast	120
Circumcision	121
Gynecology	
D & C	122
General	123
LAVH	124
Pelvic Exams	125
Labor and Delivery	
C-Section	126-128
Vaginal Delivery	129-132

Component Photo Index	133-137
-----------------------------	---------

Vascular Access

Dressing Change Kits

Alcohol and PVP	138
BIOPATCH® Protective Disk with CHG in Organizer	138
Cardinal Health™ TD-26 Transparent Dressing	139
Mastisol® Liquid Medical Adhesive	139
PICC and CVC including BIOPATCH® Protective Disk	140
Tegaderm™ Transparent Dressing	141
Tegaderm™ CHG Transparent Dressing	141

IV Start Kits

Alcohol and PVP	142
ChlorPrep® CHG 1 mL	143-144
ChlorPrep® CHG FREPP®	145-146
ChlorPrep® CHG Swab	146
PDI Prevantics™ CHG Skin Antiseptic	147

Vein Ablation

Vein Ablation Kits

Basic Kit with PVP Scrub or ChlorPrep®	148-149
Premium Kit with PVP Scrub or ChlorPrep®	148, 150

Admission and Amenity Kits

Admission Kits

Core components included in Admission kits

Contents	Quantity
Basin, emesis	1
Basin, wash, 6 qt.	1
Carafe	1
Tissues, 2-ply	1
Tumbler	1



Admission Kit

Case Quantity: 16

Cat. No.	Contents	Quantity
GS90ADM2A	Includes core components	



Admission Kit

Case Quantity: 16

Cat. No.	Contents	Quantity
GS90ADM6A	core components plus	
	Bar soap, ¾ oz.	1
	Carafe foam jacket	1
	Soap dish	1



Admission Kit

Case Quantity: 16

Cat. No.	Contents	Quantity
GS90ADM3A	core components plus	
	Bar soap, ¾ oz.	1
	Carafe foam jacket	1
	Comb, 7 in.	1
	Hand and body lotion, 2 oz.	1
	Shampoo, 2 oz.	1
	Soap dish	1
	Toothbrush	1
	Toothpaste	1

All products listed on this page are not made with natural rubber latex.

Admission and Amenity Kits

Admission Kits



Admission Kit

Case Quantity: 16

Cat. No.	Contents	Quantity
ADM90SD11B	<i>core components</i> plus	
	Bar soap, ¾ oz.	1
	Carafe foam jacket	1
	Hand and body lotion, 4 oz.	1
	Toothbrush	1
	Toothpaste	1



Pediatric Admission Kit

Case Quantity: 25

Cat. No.	Contents	Quantity
GS90PEDI1A		
	Baby lotion, 1 oz.	1
	Baby shampoo, 1 oz.	1
	Coloring book	1
	Crayons	1
	School bus bag	1
	Tissues, 2-ply	1
	Toothbrush	1
	Toothpaste	1

CHG Bathing Kit

Our CHG bathing kits can help your patients prepare for an upcoming surgery or even bath at their bedside post-operation.

Chlorhexidine Gluconate Bathing Benefits:

- Daily washing with 2% CHG significantly reduces subsequent bloodstream infections (BSI) compared to using soap and water.
- Daily bathing with CHG in ICU or advanced care setting may lower central line-associated bloodstream infections (CLABSI).
- AORN suggests a nursing protocol of preoperative bathing with 2% CHG solution for patients undergoing general and vascular surgery.

*CHG Bathing Facts. National Center for Biotechnology Information. Available at: <https://www.ncbi.nlm.nih.gov/books/NBK133364/> & <https://www.ncbi.nlm.nih.gov/pubmed/23622827>.

CHG Bathing Kit

Case Quantity: 30

Cat. No.	Contents	Quantity
GS90CHGB1		
	Bathing suggested use sheet	1
	Chlorhexidine Gluconate Solution, 2%, 4 oz. bottle	1
	White washcloth, 11 x 13 in., cotton	6



All products listed on this page are not made with natural rubber latex.

Admission and Amenity Kits

Amenity Kits

Core components included in Amenity kits

Contents	Quantity
Bar soap, ¾ oz.	1
Comb, 7 in.	1
Conditioner, 2 oz.	1
Deodorant, roll-on, 1.5 oz.	1
Hand and body lotion, 2 oz.	1
Shampoo, 2 oz.	1
Toothbrush	1
Toothpaste	1



Amenity Kit

Case Quantity: 25

Cat. No.	Contents	Quantity
GS90AMNMM	<i>Includes core components</i>	

Amenity Kit with Mouthrinse

Case Quantity: 25

Cat. No.	Contents	Quantity
GS90AMN2B	<i>core components plus</i> Alcohol-free mouthrinse, 4 oz.	1



Shave Kit

Case Quantity: 100

Cat. No.	Contents	Quantity
GS90SHAV1A	Razor, twin blade	1
	Shave cream, 1.5 oz.	1

Sterile Comb

Case Quantity: 50

Cat. No.	Contents	Quantity
14-1200	Comb, 7 in.	1

All products listed on this page are not made with natural rubber latex.

Admission and Amenity Kits

Baby Care Kits

Core components included in Baby Care kits

Contents	Quantity
Comb	1
Soap, pediatric	1



Baby Care Kit

Case Quantity: 30

Cat. No.
GS90BAB3A

Contents	Quantity
<i>core components plus</i>	
Bowl	1

Baby Care Kit

Case Quantity: 12

Cat. No.
GS90BAB4A

Contents	Quantity
<i>core components plus</i>	
Syringe	1
Tape measure	1
Wipes, pack	1



Baby Care Kit

Case Quantity: 8

Cat. No.
GS90BAB2A

Contents	Quantity
<i>core components plus</i>	
Diapers	20
Lotion, pediatric	1
Lubricating jelly	1
Syringe	1
Tape measure	1
Thermometer, digital	1
Wipes, pack	1



Baby Care Kit

Case Quantity: 12

Cat. No.
GS90BAB5A

Contents	Quantity
<i>core components plus</i>	
Lubricating jelly	1
Syringe	1
Tape measure	1
Thermometer, digital	1
Wipes, pack	1

All products listed on this page are not made with natural rubber latex.

Admission and Amenity Kits

Better Stay Kit

The Better Stay kit is **designed with both you — and HCAHPS standards — in mind** to promote a positive patient experience and restorative stay for your patients. Hospital Consumer Assessment of Healthcare Providers and Systems (HCAHPS) survey scores are becoming increasingly important. With heightened transparency and patient involvement when electing a facility for care, it's crucial to ensure a positive experience to attract consumers.

- **Encourage a quiet, restful atmosphere**
 - Ear plugs
- **Help establish comfort**
 - Lip balm and eye mask
- **Promote meaningful patient/care provider communication**
 - Better Stay journal and pencil



Better Stay Kit

Case Quantity: 50

Cat. No.	Contents	Quantity
GS90PEBS01	Better Stay journal	1
	Ear plugs	1
	Eye mask	1
	Lip balm	1
	Pencil	1

Admission and Amenity Kits

Carafes

Core components included in Carafe kits

Contents	Quantity
Carafe	1
Carafe foam jacket	1



Carafe and Foam Jacket Kit

Case Quantity: 50

Cat. No.	Contents	Quantity
GS90ADM4A	Includes core components	



Carafe, Foam Jacket and Tumbler Kit

Case Quantity: 50

Cat. No.	Contents	Quantity
GS90ADM1A	core components plus	
	Tumbler	1



Carafe, Foam Jacket and Inner Foam Liner Kit

Case Quantity: 50

Cat. No.	Contents	Quantity
GS90ADM5A	core components plus	
	Carafe foam inner liner	1

All products listed on this page are not made with natural rubber latex.

Admission and Amenity Kits

Denture, Mouthcare Kits



Denture Kit

Case Quantity: 50

Cat. No.	Contents	Quantity
GS90MOUT1A	Denture cleansing tablets	1
	Denture cup	1
	Denture toothbrush	1

Core components included in Toothcare kits

Contents	Quantity
Toothbrush	1
Toothpaste	1



Toothcare Kit

Case Quantity: 100

Cat. No.	Contents	Quantity
GS90MOUT2A	<i>Includes core components</i>	



Toothcare Kit with Comb and Mouthrinse

Case Quantity: 50

Cat. No.	Contents	Quantity
GS90MOUT3B	<i>core components plus</i>	
	Alcohol-free mouthrinse, 4 oz.	1
	Comb, 7 in.	1



Toothcare Kit with Comb

Case Quantity: 50

Cat. No.	Contents	Quantity
GS90MOUTNM	<i>core components plus</i>	
	Comb, 7 in.	1

All products listed on this page are not made with natural rubber latex.

Admission and Amenity Kits

Delivery Kits

Core components included in Delivery Apparel kits

Contents	Quantity
Bouffant	1
Face mask	1
Shoe covers	2



Delivery Apparel Kit

Case Quantity: 16

Cat. No.	Contents	Quantity
GS90MAT4A	<i>core components</i> plus	
	Scrub top, X-Large	1
	Scrub bottom, X-Large	1

Delivery Apparel Kit

Case Quantity: 16

Cat. No.	Contents	Quantity
GS90MAT2A	<i>core components</i> plus	
	Scrub top, large	1
	Scrub bottom, large	1

All products listed on this page are not made with natural rubber latex.

Admission and Amenity Kits

Fall Prevention Kits

Core components included in Fall Prevention kits

Contents	Quantity
Alert identification band, adult/pediatric, "FALL RISK"	1
Slippers, yellow, X-Large	1



Fall Prevention Basic Kit

Case Quantity: 16

Cat. No.	Contents	Quantity
GS90PEFP1	core components plus	
	Magnet, rectangle, "FALL RISK" vertical text	1



Fall Prevention Premium Kit

Case Quantity: 16

Cat. No.	Contents	Quantity
GS90PEFP2	core components plus	
	Magnet, square, blank	1
	Sticker, "Fall Precautions" text with patient rendering	2

Fall Prevention Deluxe Kit

Case Quantity: 16

Cat. No.	Contents	Quantity
GS90PEFP3	core components plus	
	Blanket, polyester fiber, flame retardant	1
	Magnet, rectangle, "FALL RISK" vertical text	1

All products listed on this page are not made with natural rubber latex.

Admission and Amenity Kits

Maternity Kits

Core components included in Maternity kits

Contents	Quantity
Briefs, stretch	2
OB pads, maxi	9
Perineal bottle	1



Maternity Kit with Towelettes

Case Quantity: 6

Cat. No.	Contents	Quantity
GS90MAT6A	<i>core components plus</i>	
	OB liners	4
	OB pads, peach	12
	Sanitary bags	12
	Towelettes	24
	Underpads	5

Maternity Kit

Case Quantity: 12

Cat. No.	Contents	Quantity
GS90MAT5A	<i>Includes core components</i>	



Maternity Kit with Baby Care Components

Case Quantity: 6

Cat. No.	Contents	Quantity
GS90MAT11A	<i>core components plus</i>	
	Baby comb, 2 sided	1
	Baby shampoo and bodywash, 1 oz.	1
	Baby wipes, pack of 40	1
	Bag, drawstring 19 x 21 in.	1
	Bags, napkin disposable	12
	Mesh pants, X-Large	2
	OB pads, regular, contoured, peach	12
	OB pads, thin with wings and adhesive	9
	Syringe, bulb, 2 oz.	1
	Tape measure, 24 in.	1
	Underpad, 30 x 30 in.	5

Maternity Kit

Case Quantity: 16

Cat. No.	Contents	Quantity
GS90MAT1A	<i>core components plus</i>	
	OB pads, peach	12
	Sanitary bags	12
	Underpads	5

All products listed on this page are not made with natural rubber latex.

Admission and Amenity Kits

Maternity Briefs and Pad Kits



Maternity Kit

Case Quantity: 6

Cat. No.	Contents	Quantity
GS90MAT3A	Brief, stretch	1
	Cold packs	4



Maternity Kit

Case Quantity: 150

Cat. No.	Contents	Quantity
GS90MAT8A	Briefs, stretch	2



Maternity Kit

Case Quantity: 4

Cat. No.	Contents	Quantity
GS90MAT7A	Cold packs	6

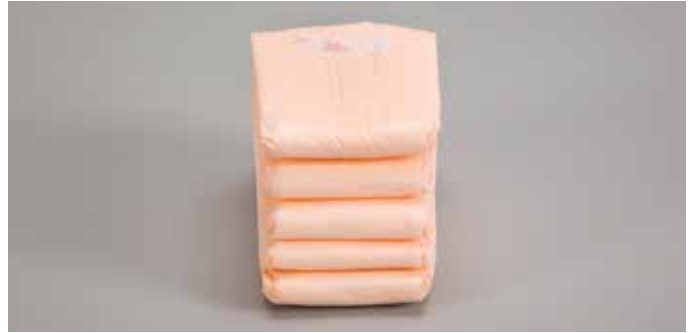

Maternity Kit

Case Quantity: 40

Cat. No.	Contents	Quantity
GS90MAT10A	OB pads, peach	5



Maternity Kit

Case Quantity: 24

Cat. No.	Contents	Quantity
GS90MAT9A	OB liners	6

All products listed on this page are not made with natural rubber latex.

Anesthesia Kits

Standard Anesthesia Circuit Kits

Standard Anesthesia Circuit Kits

Cardinal Health offers Standard Anesthesia Circuit Kit options that are pre-assembled based on popular configurations in the industry that can help meet your clinical needs.

Presource Kit Code	Circuit cat. no.	Adult/ PED	Length	HME or HMEF	BV filters	Wye	Hose Clip	Elbow w/ GSP	Breathing Bag	Gas Sampling Line	Breathing Mask
Coaxial (Single Limb)											
ANACX9601	WCACX9002A	Adult	96 in.	HMEF	0	n/a	Yes	Yes	3 L, blown	10 ft. x .060 ID m/m	Traditional, size 6
ANACX7208	WCACX7202A	Adult	72 in.	HMEF	0	n/a	Yes	Yes	3 L, blown	10 ft. x .060 ID m/m	Traditional, size 6
ANACX7210	WCACX7202A	Adult	72 in.	HMEF	0	n/a	Yes	Yes	3 L, blown	10 ft. x .060 ID m/m	Comfort soft plus, size 5
ANACX720A	WCACX7200A	Adult	72 in.	HME	1	n/a	No	Yes	3 L, blown	n/a	n/a
ANACX7202	WCACX7205A	Adult	72 in.	n/a	2	n/a	Yes	Yes	3 L, blown	10 ft. x .060 ID m/m	Traditional, size 6
ANACX7207	WCACX7205A	Adult	72 in.	n/a	2	n/a	Yes	Yes	3 L, blown	10 ft. x .060 ID m/m	Flexible, size 5
ANACX7209	WCACX7205A	Adult	72 in.	n/a	2	n/a	Yes	Yes	3 L, blown	10 ft. x .050 ID m/m	Comfort soft plus, size 5
ANACX7211	WCACX7204A	Adult	72 in.	n/a	1	n/a	No	Yes	3 L, blown	n/a	Flexible, size 5
ANACX7203	WCACX7206A	Adult	72 in.	n/a	1 - elbow	n/a	No	Yes	3 L, blown	10 ft. x .060 ID m/m	n/a
ANACX6004	WCACX6004A	Adult	60 in.	n/a	2	n/a	No	Yes	3 L, blown	10 ft. x .060 ID m/m	Flexible, size 5
ANACX6005	WCACX6003A	Adult	60 in.	n/a	1	n/a	No	Yes	3 L, blown	10 ft. x .060 ID m/m	Comfort soft plus, size 6
Corrugated (Dual Limb)											
ANACR6002	WCACR6001A	Adult	60 in.	n/a	1	Parallel	Yes	Yes	3 L, blown	10 ft. x .060 ID m/m	n/a
ANACR6001	WCACR6004A	Adult	60 in.	n/a	1 - elbow	Parallel	No	Yes	3 L, blown	n/a	n/a
ANACX7206	WCACR4001A	Adult	40 in.	n/a	1 - elbow	Parallel	No	Yes	3 L, blown	10 ft. x .060 ID m/m	n/a
Expandable (Dual Limb)											
ANACEX1081	WCAEX1085A	Adult	108 in.	HMEF	0	Parallel	No	Yes	3 L, blown	10 ft. x .060 ID m/m	n/a
ANACEX9612	WCAEX9601A	Adult	96 in.	HME	0	Parallel	No	Yes	3 L, blown	10 ft. x .060 ID m/m	Comfort soft plus, size 6
ANACEX9605	WCAEX9607A	Adult	96 in.	n/a	2	Parallel	Yes	Yes	3 L, blown	10 ft. x .060 ID m/m	n/a
ANACEX960A	WCAEX9605A	Adult	96 in.	n/a	1	Parallel w/ GSP	No	Yes	3 L, blown	n/a	n/a
ANACEX9606	WCAEX9605A	Adult	96 in.	n/a	1	Parallel w/ GSP	No	Yes	2 L, blown	n/a	Traditional, size 5
ANACEX9601	WCAEX9609A	Adult	96 in.	n/a	1 - elbow	Parallel	No	Yes	3 L, blown	n/a	Traditional, size 6
ANACEX9604	WCAEX9609A	Adult	96 in.	n/a	1 - elbow	Parallel	No	Yes	3 L, blown	10 ft. x .060 ID m/m	Traditional, size 5
ANACEX9602	WCAEX9609A	Adult	96 in.	n/a	1 - elbow	Parallel	No	Yes	3 L, blown	n/a	n/a
ANACEX9611	WCAEX9604A	Adult	96 in.	n/a	0	Parallel	No	Yes	3 L, blown	n/a	Comfort soft plus, size 5
ANPCX9602	WCPEX9602A	PED	96 in.	n/a	1 - Elbow	Parallel	No	Yes	1 L, dipped	10 ft. x .060 ID m/m	n/a

All products listed on this page are not made with natural rubber latex.

Burn Kits

Burn Dressings



Small Burn Kit

Case Quantity: 33

Cat. No.	Contents	Quantity
17-0100A	Burn dressing 8 x 3 in.	2
	Burn dressing 18 x 9 in.	5
	Conforming bandage 4 in.	4
	Gauze, 4 x 4 in., 12-ply	10
	Towel, white, poly lined, 17 x 22 in.	1

Medium Burn Kit

Case Quantity: 29

Cat. No.	Contents	Quantity
17-0200	Burn dressing 8 x 3 in.	4
	Burn dressing 18 x 9 in.	10
	Burn dressing 35 x 23 in.	4
	Conforming bandage 4 in.	4
	Conforming bandage 6 in.	2
	Gauze, 4 x 4 in., 12-ply	20
	Towel, white, poly lined 23 x 24 in.	1

Large Burn Kit

Case Quantity: 6

Cat. No.	Contents	Quantity
17-0300A	Burn dressing 8 x 3 in.	12
	Burn dressing 18 x 9 in.	25
	Burn dressing 35 x 23 in.	2
	Conforming bandage 4 in.	8
	Conforming bandage 6 in.	4
	Gauze, 4 x 4 in., 12-ply	20
	Towel, white, poly lined 28 x 28 in.	1

All products listed on this page are not made with natural rubber latex.

Cath Lab Kits

Cardiac Cath



Cardiac Cath Kit

Case Quantity: 3

Cat. No.
28100-200

Contents	Quantity
Bandbag, 36 x 28 in.	1
Bowl, guidewire, 2500 cc	1
Bowl, sponge, 16oz., 500 cc	1
Drape, femoral, angiography, 80 x 112 in.	1
Gowns, Astound®, X-Large	2
Mayo tray cover, 12¾ x 19 in.	1
Medicine cup, 2 oz., 60 cc, graduated	1
Needles, 18G x 1½ in.	2
Needle, 22G x 1½ in.	1
Needle, 25G x 1½ in.	1
One-compartment tray, 9 x 4¾ x 2 in.	1
Sponges, 4 x 4 in., 16-ply, x-ray	4
Syringe, control, luer lock, 10 mL	1
Syringes, luer lock, 10 mL	4
Syringes, luer lock, 20 mL	2
Table cover, 50 x 90 in.	1
Towels, OR, blue	8

Femoral angiography drape

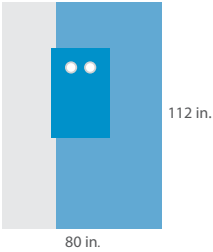

Cardiac Cath Procedure Kit

Case Quantity: 2

Cat. No.
28100-100

Contents	Quantity
Bowl, guidewire, 2500 cc	1
Bowl, sponge, 16oz., 500 cc	1
Bowl, sponge, 32oz., 1000 cc	1
Drape, angiography, reinforced pouch, 77 x 111 in.	1
Gowns, Astound®, X-Large	2
Label, atropine, waterproof	1
Labels, heparin, waterproof	2
Labels, xylocaine, waterproof	2
Mayo tray cover, 12¾ x 19 in.	1
Medicine cup, 2 oz., 60 cc, graduated	1
Needles, 18G x 1½ in.	4
Needles, 22G x 1½ in.	2
Needle, 27G x 1½ in.	1
One-compartment tray, 9 x 4¾ x 2 in.	1
Scalpel, #11, safety	1
Sponges, 4 x 4 in., 12-ply	30
Syringe, control, luer lock, 10 mL	1
Syringe, luer lock, 3 mL	1
Syringe, luer lock, 5 mL	2
Syringe, luer lock, 10 mL	5
Syringe, luer lock, 30 mL	1
Table cover, 50 x 90 in.	1
Towel, absorbent, white	1
Towel, OR, blue	2

Femoral angiography drape

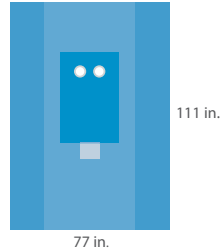

Guidewire Bowl with Lid

Case Quantity: 20

Cat. No. SSK9009A

Contents	Quantity
Bowl, guidewire, 2500 cc with lid	1



	Basic drape fabric		Reinforcements		Side panel material
	Adhesive		Incise		Clear plastic panels and pouches

All products listed on this page are not made with natural rubber latex.

Cath Lab Kits

Cath Angio, Cath Lab Plus



Cath Angio Kit

Case Quantity: 4

Cat. No.
SPP99CAANA

Femoral angiography drape

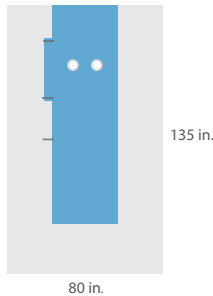

Contents	Quantity
Bandbag, 36 x 40 in., with tape	1
Bowl, guidewire, 2500 cc	1
Bowl, sponge, 32oz., 1000 cc	1
Clamps, towel, 4½ in., plastic, blue, curved	4
Cover, setup, 54 x 90 in.	1
Drape, femoral angiography, 80 x 135 in.	1
Forcep, Halstead Mosquito, 5 in., curved	1
Gowns, Astound®, X-Large	2
Introducer, guidewire, 18G x 7 cm	1
Labels, sheet of 22, waterproof	1
Marker, skin, dual tip	1
Medicine cup, 2 oz., 60 cc, graduated	1
Needle holder, nest, foam block	1
Needle, 18G x 1½ in.	1
Needle, 25G x 1½ in.	1
Scalpel, #11, safety	1
Sponges, 4 x 4 in., 4-ply	40
Syringe, control, luer lock, 10 mL	1
Syringes, luer lock, 10 mL	4
Syringes, luer lock, 20 mL	2
Table cover, 50 x 90 in.	1
Towels, absorbent, white	2
Towels, OR, blue	4

Cath Lab Plus Kit

Case Quantity: 4

Cat. No.
SPP99CAPLA

Femoral angiography drape

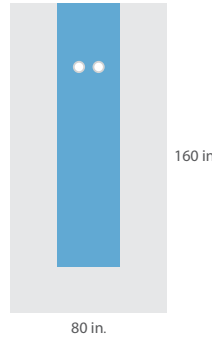

Contents	Quantity
Bandbag, 36 x 40 in., with tape	1
Bowl, guidewire, 2500 cc	1
Bowl, sponge, 16oz., 500 cc	1
Bowl, sponge, 32oz., 1000 cc	1
Clamps, towel, 4½ in., plastic, blue, curved	4
Cover, setup, 54 x 90 in.	1
Domebag, 26 in. deep	1
Drape, femoral angiography, 80 x 160 in.	1
Forcep, Halstead Mosquito, 5 in., straight	1
Forcep, Halstead Mosquito, 5 in., curved	1
Gowns, Astound®, X-Large	2
Introducer, guidewire, 18G x 7 cm	1
Labels, sheet of 22, waterproof	1
Marker, skin, dual tip	1
Medicine cups, 2 oz., 60 cc, graduated	2
Needle holder, nest, foam block	1
Needle holder, Webster, 5 in., large rings	1
Needle, 18G x 1½ in.	1
Needle, 25G x 1½ in.	1
Scalpel, #11, safety	1
Scissors, 5½ in., straight, sharp/blunt	1
Sponges, 4 x 4 in., 4-ply	40
Syringe, control, luer lock, 10 mL	1
Syringes, luer lock, 10 mL	4
Syringes, luer lock, 20 mL	4
Table cover, 50 x 90 in.	1
Towels, absorbent, white	2
Towels, OR, blue	8
Tray, organizer, 5 x 4 x 2 in.	1

Basic drape fabric	Reinforcements	Side panel material
Adhesive	Incise	Clear plastic panels and pouches

All products listed on this page are not made with natural rubber latex.

Cath Lab Kits

Cath Lab Plus with ChloraPrep®, Pacemaker



Cath Lab Plus with ChloraPrep® Kit

Case Quantity: 4

Cat. No.	Contents	Quantity
SPP99CAPCA	Applicators, ChloraPrep®, 2%, 10.5 mL with orange tint	2
	Bandbag, 36 x 40 in., with tape	1
	Bowl, guidewire, 2500 cc	1
	Bowl, sponge, 16oz., 500 cc	1
	Bowl, sponge, 32oz., 1000 cc	1
	Clamps, towel, 4.5 in., plastic, blue, curved	4
	Cover, setup, 54 x 90 in.	1
	Domebag, 26 in. deep	1
	Drape, femoral angiography, 80 x 160 in.	1
	Forcep, Halstead Mosquito, 5 in., straight	1
	Forcep, Halstead Mosquito, 5 in., curved	1
	Gowns, Astound®, X-Large	2
	Introducer, guidewire, 18G x 7 cm	1
	Labels, sheet of 22, waterproof	1
	Marker, skin, dual tip	1
	Medicine cups, 2 oz., 60 cc, graduated	2
	Needle holder, nest, foam block	1
	Needle holder, Webster, 5 in., large rings	1
	Needle, 18G x 1½ in.	1
	Needle, 25G x 1½ in.	1
	Scalpel, #11, safety	1
	Scissors, 5½ in., straight, sharp/blunt	1
	Sponges, 4 x 4 in., 4-ply	40
	Syringe, control, luer lock, 10 mL	1
	Syringes, luer lock, 10 mL	4
	Syringes, luer lock, 20 mL	4
	Table cover, 50 x 90 in.	1
	Towels, absorbent, white	2
	Towels, OR, blue	8

Femoral angiography drape

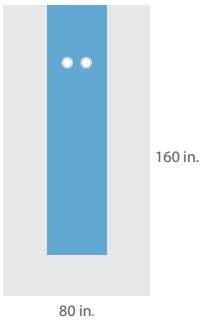

Pacemaker Kit

Case Quantity: 4

Cat. No.	Contents	Quantity
SPP99PM3AA	Bag, bedside with tabs, flame retardant	1
	Bandbag, 36 x 40 in.	1
	Bowl, sponge, 16oz., 500 cc	1
	Bowl, sponge, 32oz., 1000 cc	1
	Cautery, pencil, push button, holster, 10 ft., coated blade electrode	1
	Clamps, towel, 4½ in., plastic, blue, curved	2
	Drape, pacemaker	1
	Gauze, sponge, 4 x 4 in., 16-ply, x-ray, 10 each	1
	Gowns, Astound®, X-Large	2
	Handle, suction, yankauer, bulbous tip, non-vented	1
	Labels, sheet of 22, waterproof	1
	Marker, skin, dual tip	1
	Medicine cup, 2 oz., 60 cc, graduated	1
	Needle holder, 10-20 count with foam block and magnet	1
	Needle, 18G x 1½ in.	1
	Needle, 25G x 1½ in.	1
	Scalpel, #15, safety	1
	Syringe, asepto, 50 cc	1
	Syringes, luer lock, 10 mL	2
	Table cover, 65 x 90 in.	1
	Towels, absorbent, white	2
	Towels, OR, blue	8
	Tubing, suction, non-conductive, 6 mm x 12 ft.	1

Pacemaker drape

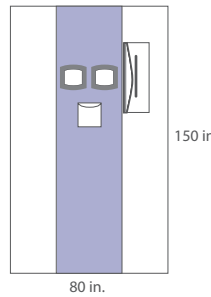

	Basic drape fabric		Reinforcements		Side panel material
	Adhesive		Incise		Clear plastic panels and pouches

	Adhesive		Absorbent Reinforcement
	Clear Film		Clear Antimicrobial Adhesive

All products listed on this page are not made with natural rubber latex.

Diagnostic Procedure Trays

Diagnostic Procedures – Lumbar Puncture



Conventional Offering

	Lumbar Puncture with Spinal Needle, 20G x 3.5 in.	Lumbar Puncture Pediatric with Spinal Needle, 22G x 1.5 in.	Lumbar Puncture with Spinal Needle, 22G x 3.5 in.	Lumbar Puncture with Atraumatic Spinal Needle, 22G x 3.5 in.	Lumbar Puncture with Spinal Needle, 18G x 3.5 in.	Lumbar Puncture with Spinal Needle, 20G x 3.5 in.	Pediatric/Infant Lumbar Puncture Tray with Spinal Needle, 21G x 2.5 in.	Neonatal Lumbar Puncture Tray with Spinal Needle, 25G x 1 in.
Cat. No. with Drug	26-LP1CO	26-LP2CO	26-LP3CO	26-LP4CO	26-LP6CO	26-LP7CO	99-LP1CO	99-LP4CO
Cat. No. without Drug	26-LP1CODF	26-LP2CODF	26-LP3CODF	26-LP4CODF	26-LP6CODF	26-LP7CODF	99-LP1CODF	99-LP4CODF
Case Quantity	10	10	10	10	10	10	10	10
Carefusion Cross Reference	4301C	4302	4306C	4306CW	4303C		4304C	

Core Components included in Lumbar Puncture trays								
Adhesive bandage, fabric, ¾ x 3 in.	1	1	1	1	1	1	1	1
Alcohol prep pad							1	
CSR wrap, 30 x 30 in.	1	1	1	1	1	1	1	1
Drape, blue, 18 x 24 in. with 4 in. fenestration	1	1	1	1	1	1	1	
Drape, 13 x 13 in. with 2¾ x 2¾ in. fenestration								1
Foam needle block	1	1	1	1	1	1		
Gauze, 2 x 2 in., 8-ply								3
Gauze, 4 x 4 in., 8-ply	10	10	10	10	10	10	3	
Labels, 5/sheet	1	1	1	1	1	1		
Lidocaine, 2%, glass ampule, 10 mL	1	1	1	1	1	1	1	
Marker, fine tip, utility	1	1	1	1	1	1		
Instrument protector, 7x10 in.								2
PVP-I swabstick, 3 pack	1	1	1	1	1	1	1	
Stopcock, 3-way, male	1	1	1	1	1	1	1	
Syringe, luer lock, 3cc, 25G x 5 in. needle							1	
Syringe, luer lock, 5 mL	1	1	1	1	1	1		
Tubing, extension set, 5 in.	1	1	1	1	1	1	1	
Vial with cap, clear #1, 8 mL	1	1	1	1	1	1	1	1
Vial with cap, clear #2, 8 mL	1	1	1	1	1	1	1	1
Vial with cap, clear #3, 8 mL	1	1	1	1	1	1	1	1
Vial with cap, clear #4, 8 mL	1	1	1	1	1	1	1	1
Towel, white, poly lined, 17x18 in.	1	1	1	1	1	1	1	
Core components Plus below								
BD Precision Glide® filter needle, 19G x 1½ in.	1	1	1	1	1	1		
BD Precision Glide® hypodermic needle, 22G x 1½ in.	1	1	1	1	1	1	1	
BD Precision Glide® hypodermic needle, 25G x ¾ in. with shield	1	1	1	1	1	1		
BD Needle, spinal, 21G x 2½ in.							1	
BD Needle, Quincke, spinal, 18G x 3½ in.					1			
BD Needle, Quincke, spinal, 20G x 3½ in.	1					1		
BD Needle, Quincke, spinal, 22G x 1½ in.		1						
BD Needle, Quincke, spinal, 22G x 3½ in.			1					
BD Needle, neonatal, spinal, 25G x 1 in.			1					1
BD Needle, Whitacre, spinal, 22G x 3½ in.				1				
Manometer, one-piece	1	1	1	1	1	1	1	
Manometer, two-piece	1		1	1	1	1		

All products listed on this page are not made with natural rubber latex.

Diagnostic Procedure Trays

Diagnostic Procedures – Lumbar Puncture



Safety Offering

	Safety Lumbar Puncture with Spinal Needle 22G x 3.5 in.	Safety Lumbar Puncture with Spinal Needle 20G x 3.5 in.	Safety Lumbar Puncture with Spinal Needle, Pediatric 22G x 1.5 in.	Safety Lumbar Puncture with Spinal Needle 22G x 3.5 in.	Safety Lumbar Puncture with Atraumatic Spinal Needle 22G x 3.5 in.	Safety Lumbar Puncture with Spinal Needle 18 G x 3.5 in.
Cat. No. with Drug	22-0035	26-LP1SF	26-LP2SF	26-LP3SF	26-LP4SF	26-LP6SF
Cat. No. without Drug	22-0035DF	26-LP1SDF	26-LP2SDF	26-LP3SDF	26-LP4SDF	26-LP6SDF
Case Quantity	25	10	10	10	10	10
Carefusion Cross Reference		4301CSP	4302CSP	4306CSP	4306CWSP	

Core Components included in Lumbar Puncture trays – see page 44 for additional components

Adhesive bandage, fabric, ¾ x 3 in.		1	1	1	1	1
Adhesive bandage, plastic, 1 x 3 in.	1					
Alcohol prep pad	1					
CSR wrap, 23 x 24 in.	1					
CSR wrap, 30 x 30 in.		1	1	1	1	1
Drape, blue, 18 x 24 in. with 4 in. fenestration		1	1	1	1	1
Drape, white, 18 x 18 in.	1					
Foam needle block		1	1	1	1	1
Gauze, 3 x 3 in., 12-ply	5					
Gauze, 4 x 4 in., 8-ply		10	10	10	10	10
Labels, 5/sheet		1	1	1	1	1
Lidocaine, 2%, glass ampule, 10 mL	1	1	1	1	1	1
Marker, fine tip, utility		1	1	1	1	1
Protector pouch, single pocket	1					
PVP-I swabstick, 3 pack	1	1	1	1	1	1
Ruler, 6 in., flexible	1					
Stopcock, 3-way, male		1	1	1	1	1
Safety scalpel, #11, stainless steel	1					
Syringe, luer lock, 5 mL		1	1	1	1	1
Syringe, luer lock, 10 mL	2					
Syringe, luer lock, 20 mL	1					
Towel, absorbent	1					
Tubing, extension set, 5 in.		1	1	1	1	1
Vial with cap, clear #1, 8 mL		1	1	1	1	1
Vial with cap, clear #2, 8 mL		1	1	1	1	1
Vial with cap, clear #3, 8 mL		1	1	1	1	1
Vial with cap, clear #4, 8 mL		1	1	1	1	1
Towel, white, poly lined, 17 x 18 in.		1	1	1	1	1
Ziplock bag	1					

All products listed on this page are not made with natural rubber latex.

Diagnostic Procedure Trays

Diagnostic Procedures – Lumbar Puncture



Safety Offering

	Safety Lumbar Puncture with Spinal Needle 22G x 3.5 in.	Safety Lumbar Puncture with Spinal Needle 20G x 3.5 in.	Safety Lumbar Puncture with Spinal Needle, Pediatric 22G x 1.5 in.	Safety Lumbar Puncture with Spinal Needle 22G x 3.5 in.	Safety Lumbar Puncture with Atraumatic Spinal Needle 22G x 3.5 in.	Safety Lumbar Puncture with Spinal Needle 18 G x 3.5 in.
Cat. No. with Drug	22-0035	26-LP1SF	26-LP2SF	26-LP3SF	26-LP4SF	26-LP6SF
Cat. No. without Drug	22-0035DF	26-LP1SFDF	26-LP2SFDF	26-LP3SFDF	26-LP4SFDF	26-LP6SFDF
Case Quantity	25	10	10	10	10	10
Carefusion Cross Reference		4301CSP	4302CSP	4306CSP	4306CWSP	

Core components page 43 Plus below						
BD Needle, Quincke, spinal, 18G x 3½ in.						1
BD Needle, Quincke, spinal, 20G x 3½ in.		1				
BD Needle, Quincke, spinal, 22G x 1½ in.			1			
BD Needle, Quincke, spinal, 22G x 3½ in.				1		
BD Needle, Whitacre, spinal, 22G x 3½ in.					1	
BD Precision Glide® hypodermic needle, 18G x 1½ in., safety	1					
BD Precision Glide® hypodermic needle, 22G x 1½ in., safety	1	1	1	1	1	1
BD Precision Glide® hypodermic needle, 25G x ¾ in., safety		1	1	1	1	1
BD Precision Glide® hypodermic needle, 25G x 1 in., safety	1					
FILTER STRAW®, 5 micron, 1¾		1	1	1	1	1
Manometer, one-piece		1	1	1	1	1
Manometer, two-piece		1		1	1	1

Accessories

Vial set, 10 mL

Case Quantity: 40

Cat. No.	Contents	Quantity
SPP99DPTVL	Vial with cap, clear, #1, 8 mL	1
	Vial with cap, clear, #2, 8 mL	1
	Vial with cap, clear, #3, 8 mL	1
	Vial with cap, clear, #4, 8 mL	1

Manometer, large with stopcock

Case Quantity: 20

Cat. No.	Contents	Quantity
99-MA1CO	Manometer, one-piece	1
	Manometer, two-piece	1

All products listed on this page are not made with natural rubber latex.

Diagnostic Procedure Trays

Diagnostic Procedures – Myelogram



Conventional and Safety Offering

	Myelogram with Spinal Needle 22G x 3.5 in.	Safety Myelogram with Spinal Needle 22G x 3.5 in.	Myelogram, Atraumatic Spinal Needle 22G x 3.5 in.
Cat. No. with Drug	27-MY1CO	27-MY1SF	27-MY2CO
Cat. No. without Drug	27-MY1CODF	27-MY1CODF	27-MY2CODF
Case Quantity	10	10	10
Carefusion Cross Reference	4320	4324ASP	4324AW

Core Components included in Myelogram trays			
Adhesive bandage, fabric, ¾ x 3 in.	1	1	1
BD Needle, arterial, 18G x 1½ in.	1	1	1
CSR wrap, 30 x 30 in.	1	1	1
Drape, blue, 18 x 24 in. with 4 in. fenestration	1	1	1
Foam needle block	1	1	1
Gauze, 4 x 4 in., 8-ply	10	10	10
Labels, 5/sheet	1	1	1
Lidocaine, 2%, glass ampule, 10 mL	1	1	1
Marker, fine tip, utility	1	1	1
PVP-I swabstick, 3 pack	1	1	1
Syringe, luer lock, 5 mL	1	1	1
Syringe, luer lock, 20 mL	1	1	1
Tubing, extension set, 5 in.	1	1	1
Tubing, extension set, 20 in.	1	1	1
Vial with cap, clear #1, 8 mL	1	1	1
Vial with cap, clear #2, 8 mL	1	1	1
Towel, white, poly lined, 17 x 18 in.	1	1	1
Core components Plus below			
BD Precision Glide® filter needle, 19G x 1½ in.	1		1
BD Precision Glide® hypodermic needle, 22G x 1½ in.	1		1
BD Precision Glide® hypodermic needle, 22G x 1½ in., safety		1	
BD Precision Glide® hypodermic needle, 25G x ⅝ in.	1		1
BD Precision Glide® hypodermic needle, 25G x ⅝ in., safety		1	
BD Needle, Quincke, spinal, 22G x 3½ in.	1	1	
BD Needle, Whiteacre, spinal, 22G x 3½ in.			1
FILTER STRAW®, 5 micron, 1¾ in.		1	

All products listed on this page are not made with natural rubber latex.

Diagnostic Procedure Trays

Diagnostic Procedures – Arthrogram



Conventional and Safety Offering

	Arthrogram with Spinal Needle 22G x 3.5 in.	Safety Arthrogram with Spinal Needle 22G x 3.5 in.
Cat. No. with Drug	28-AR1CO	28-AR1SF
Cat. No. without Drug	28-AR1CODF	28-AR1SDFD
Case Quantity	10	10
Carefusion Cross Reference	4325	4325SP

Core Components included in Arthrogram trays

Component	Arthrogram with Spinal Needle 22G x 3.5 in.	Safety Arthrogram with Spinal Needle 22G x 3.5 in.
Adhesive bandage, fabric, ¾ x 3 in.	1	1
BD Needle, arterial, 18G x 1½ in.	1	1
ChloroPrep®, 2% applicator	1	1
CSR wrap, 30 x 30 in.	1	1
Drape, blue, 18 x 24 in. with 4 in. fenestration	1	1
Foam needle block	1	1
Gauze, 4 x 4 in., 8-ply	10	10
Labels, 5/sheet	1	1
Lidocaine, 2%, glass ampule, 10 mL	1	1
Marker, fine tip, utility	1	1
Syringe, luer lock, 5 mL	1	1
Syringe, luer lock, 20 mL	1	1
Tubing, extension set, 20 in.	1	1
Towel, white, poly lined, 17 x 18 in.	1	1

Core components Plus below

Component	Arthrogram with Spinal Needle 22G x 3.5 in.	Safety Arthrogram with Spinal Needle 22G x 3.5 in.
BD Precision Glide® hypodermic needle, 22G x 1½ in.	1	
BD Precision Glide® hypodermic needle, 22G x 1½ in., safety		1
BD Precision Glide® hypodermic needle, 25G x ½ in.	1	
BD Precision Glide® hypodermic needle, 25G x ½ in., safety		1
BD Precision Glide® filter needle, 19G x 1½ in.	1	
BD Needle, Quincke, spinal, 22G x 3½ in.	1	1
FILTER STRAW®, 5 micron, 1¾ in.		1

All products listed on this page are not made with natural rubber latex.

Diagnostic Procedure Trays

Diagnostic Procedures – Amniocentesis



Conventional and Safety Offering

	Amniocentesis with BD Ultra-Vue Echogenic Spinal Needle 20G x 3.5 in.	Safety Amniocentesis with BD Ultra-Vue Echogenic Spinal Needle 20G x 3.5 in.	Amniocentesis Tray with Spinal Needle 20G x 6 in.
Cat. No. with Drug	29-AM1CO	29-AM1SF	29-AM2CO
Cat. No. without Drug	29-AM1CODF	29-AM1SFDF	29-AM2CODF
Case Quantity	10	10	10
Carefusion Cross Reference	4545A	4545ASP	

Core Components included in Amniocentesis trays			
Adhesive bandage, fabric, ¾ x 3 in.	1	1	1
Cap, male/female, luer-lock adapter	1	1	1
ChloroPrep®, 2% applicator	1	1	1
CSR wrap, 30 x 30 in.	1	1	1
Drape, blue, 18 x 24 in. with 4 in. fenestration	1	1	1
Foam needle block	1	1	1
Gauze, 4 x 4 in., 8-ply	10	10	10
Labels, 5/sheet	1	1	1
Lidocaine, 2%, glass ampule, 10 mL	1	1	1
Marker, fine tip, utility	1	1	1
Ruler, 6 in., flexible	1	1	1
Syringe, luer lock, 5 mL	1	1	1
Syringe, luer lock, 20 mL	1	1	1
Towel, white, poly lined, 17x18 in.	1	1	1
Tubing, extension set, 5 in.	1	1	1
Vial with cap, amber #1, 8 mL	1	1	1
Vial with cap, amber #2, 8 mL	1	1	1
Vial with cap, amber #3, 8 mL	1	1	1
Core components Plus below			
BD Precision Glide® filter needle, 19G x 1½ in.	1		1
BD Ultra-vue needle, echogenic spinal, 20G x 3½ in.	1	1	
BD Precision Glide® hypodermic needle, 22G x 1½ in.	1		1
BD Precision Glide® hypodermic needle, 22G x 1½ in., safety		1	
BD Precision Glide® hypodermic needle, 25G x ¾ in.	1		1
BD Precision Glide® hypodermic needle, 25G x ¾ in., safety		1	
FILTER STRAW®, 5 micron, 1¾ in.		1	
Needle, ultrasound tip, marked spinal, 20G x 6 in.			1

All products listed on this page are not made with natural rubber latex.

Diagnostic Procedure Trays

Acute Drainage – Paracentesis, Thoracentesis



Conventional Offering

	<i>Centesis Tray with Covidien Turkel Safety Fluid Drainage System, 8 Fr x 5 in.</i>	<i>Centesis Tray with Argon 5 Fr x 4 in. Skater Catheter</i>	<i>Centesis Tray with Merit 5 Fr x 4 in. Catheter</i>	<i>Centesis Tray with No Catheter or Needle</i>	<i>Centesis Tray with Argon Aspiration Needle, 16G x 3 in.</i>	<i>Centesis Tray with Argon 5 Fr Straight Drainage Catheter</i>	<i>Centesis Tray with Covidien Turkel Safety Fluid Drainage System, 8 Fr x 5 in.</i>	<i>Centesis Tray with Argon 8 Fr x 5 in. Catheter</i>	<i>Centesis Tray with Covidien Turkel Safety Fluid Drainage System, 8 Fr x 5 in.</i>	<i>Centesis Tray with Covidien Turkel Safety Fluid Drainage System, 8 Fr x 5 in., Drug Free</i>	<i>Centesis Tray with Argon 5 Fr x 4 in. Catheter</i>
Cat. No. with Drug	30-CE1CO	30-CE2COA	30-CE2CMA	30-CE3CO	30-CE5CO	30-CE6CO	30-CE8CO	30-CE8CA	30-CE10CO		
Cat. No. without Drug	30-CE1CODF	30-CE2COAF	30-CE2CMADF	30-CE3CODF	30-CE5CODF	30-CE6CSF	30-CE8CODF	30-CE8CADF	30-CE10CDF	30-CE13CO	30-CE14CO
Case Quantity	10	10	10	10	10	10	10	10	10	10	10
Carefusion Cross Reference	TPT1000	OTP5000	OTP5000			TPT1005	TPT1000	TPT1000	TPT1000	TPK1001	TPK1005
Argon Cross Reference	ATPT1000					ATPT1005	ATPT1000	ATPT1000	ATPT1000	ATPK1001	ATPK1005

Core Components included in Paracentesis, Thoracentesis trays – see page 22 for additional components

Adhesive bandage, ¾ x 3 in.	1	1	1	1	1	1	1	1	1		
Bag, fluid collection, 2000 mL		1	1	1	1	1	1	1	1		
Bag, drainage, tubing set, w/2 check valves		1	1	1	1	1	1	1	1		
Cap, male/female, luer-lock adapter	1	1	1	1							
Chloraprep, 2% applicator	1	1	1	1		1	1	1	1		
CSR wrap 30 x 30 in.	1	1	1	1	1	1	1	1	1		
Drape, blue, with 4 in. fenestration	1	1	1	1	1	1	1	1	1		
Dressing, transparent, 4 x 4¾ in.	1	1	1	1		1					
Dry sponge stick, 6 in.					2					1	
Foam needle block	1	1	1	1		1	1	1			
Gauze, 3 x 3 in., 12-ply					3	3	6	6	6		
Gauze, 4 x 4 in., 8-ply	10	10	10	10							
Labels, 5/sheet	1	1	1	1			1	1	1		
Lidocaine, 2%, glass ampule, 10 mL	2	2	2	2	1	2	2	2	2		
Marker, fine tip, utility	1	1	1	1							
Stopcock, 3 way, male, luer slip		1	1		1						
Surical blade, #11, safety, stainless steel	1	1	1	1		1	1	1	1	1	1
Syringe, luer lock, 5 mL	1	1	2	1	1						
Syringe, luer lock, 10 mL						1	1	1	1		
Syringe, luer lock, 30 mL	1	1		1							
Syringe, luer lock, 60 mL					1	1	1	1	1		
Towel, white 17 x 18 in.	1	1	1	1	1	1	1	1	1		
Tubing for vacuum bottle, 16G x 1½ in. needle	1	1	1	1	1	1	1	1	1	1	1
Vial with cap, clear #1, 8 mL		1	1		1	1	1	1	1		
Vial with cap, clear #2, 8 mL		1	1		1	1	1	1	1		
Vial with cap, clear #3, 8 mL		1	1		1	1	1	1	1		

All products listed on this page are not made with natural rubber latex.

Diagnostic Procedure Trays

Acute Drainage – Paracentesis, Thoracentesis



Conventional Offering

	Centesis Tray with Covidien Turkel Safety Fluid Drainage System, 8 Fr x 5 in.	Centesis Tray with Argon 5 Fr x 4 in. Skater Catheter	Centesis Tray with Merit 5 Fr x 4 in. Catheter	Centesis Tray with No Catheter or Needle	Centesis Tray with Argon Aspiration Needle, 16G x 3 in.	Centesis Tray with Argon 5 Fr Straight Drainage Catheter	Centesis Tray with Covidien Turkel Safety Fluid Drainage System, 8 Fr x 5 in.	Centesis Tray with Argon 8 Fr x 5 in. Catheter	Centesis Tray with Covidien Turkel Safety Fluid Drainage System, 8 Fr x 5 in.	Centesis Tray with Covidien Turkel Safety Fluid Drainage System, 8 Fr x 5 in. Drug Free	Centesis Tray with Argon 5 Fr x 4 in. Catheter
Cat. No. with Drug	30-CE1CO	30-CE2COA	30-CE2CMA	30-CE3CO	30-CE5CO	30-CE6CO	30-CE8CO	30-CE8CA	30-CE10CO		
Cat. No. without Drug	30-CE1CODF	30-CE2COAF	30-CE2CMADF	30-CE3CODF	30-CE5CODF	30-CE6CSF	30-CE8CODF	30-CE8CADF	30-CE10CDF	30-CE13CO	30-CE14CO
Case Quantity	10	10	10	10	10	10	10	10	10	10	10
Carefusion Cross Reference	TPT1000	OTP5000	OTP5000			TPT1005	TPT1000	TPT1000	TPT1000	TPK1001	TPK1005
Argon Cross Reference	ATPT1000					ATPT1005	ATPT1000	ATPT1000	ATPT1000	ATPK1001	ATPK1005

Core components page 21 Plus below

BD Needle, filter 19G x 1½ in.	1	1	1	1	1	1	1	1	1		
BD Precision Glide® needle, 22G x 1½ in.	1	1		1		1	1		1		
BD Needle, hypodermic, safety, 22G x 1½ in.			1					1			
BD Precision Glide® needle, 25G x ¾ in.	1	1		1	1	1	1				
BD Needle, hypodermic, 25G x ¾ in.								1			
BD Needle, hypodermic, safety, 25G x 1½ in.			1						1		
Catheter adapter ¼ to ⅝ in.		1	1	1		1	1	1			
Catheter, Argon straight centesis, 5 Fr x 4 in. with stopcock and ball valve						1					1
Catheter, Argon straight centesis, 5 Fr x 4 in. w/o stopcock or ball valve		1									
Catheter, Merit straight centesis, 5 Fr x 4 in. w/o stopcock or ball valve			1								
Catheter, Covidien Turkel, straight centesis, 8 Fr x 5 in., Safety with stopcock and ball valve	1						1		1	1	
Catheter, Argon, straight centesis, 8 Fr, Safety with stopcock and ball valve								1			
Needle, aspiration, 16 G x 3 in.					1						

All products listed on this page are not made with natural rubber latex.

Diagnostic Procedure Trays

Acute Drainage – Paracentesis, Thoracentesis



Safety Offering

	Safety Centesis Tray with Covidien Turkel Safety Fluid Drainage System, 8 Fr X 5 in.	Safety Centesis Tray with Argon, 5 Fr X 4 in. Skater Catheter	Safety Centesis Tray with Merit, 5 Fr Catheter	Safety Centesis Tray with Merit, 5 Fr Catheter And Large Bore Tubing	Safety Centesis Tray with Merit, 8 Fr Catheter	Safety Centesis Tray with no Catheter or Needle	Safety Centesis Tray with Argon Aspiration Needle, 16G X 3 in.	Safety Centesis Tray with Carefusion Aspiration Needle, 16G X 3 in.	Safety Centesis Tray with Argon, 5 Fr Straight Drainage Catheter	Safety Centesis Tray with Covidien Turkel Safety Fluid Drainage System, 8 Fr X 5 in.	Safety Centesis Tray with Covidien Turkel Safety Fluid Drainage System, 8 Fr X 5 in.
Cat. No. with Drug	30-CE1SF	30-CE2SFA	30-CE2SMA	30-CE2SF5F	30-CE2SF8F	30-CE3SF	30-CE5CS	30-CE5SF	30-CE6SF	30-CE6CSDF	30-CE8SF
Cat. No. without Drug	30-CE1SDF	30-CE2SFAF	30-CE2SMADF	30-CE2SF5D		30-CE3SDF	30-CE5CSDF	30-CE5SDF	30-CE6SDF	30-CE6CSDF	30-CE8SDF
Case Quantity	10	10	10	10	10	10	10	10	10	10	10
Carefusion Cross Reference	TPT1000SP	OTP5000	OTP5000				4340AS	4340AS	TPT1005	TPT1005SP	TPT1000SP
Argon Cross Reference	ATPT1000SP						A4340AS	A4340AS	ATPT1005	ATPT1005SP	ATPT1000SP
Merit Cross Reference				TAPS-5F-10LT							

Core Components included in Paracentesis, Thoracentesis trays – see page 24 for additional components

Adhesive bandage, ¾ x 3 in.	1	1	1	1	1	1	1	1	1	1	1
Bag, fluid collection, 2000 mL		1	1	1	1	1	1	1	1	1	1
Bag, drainage, tubing set, w/2 check valves		1	1	1	1	1	1	1	1	1	1
Cap, male/female, luer-lock adapter	1	1	1	1	1	1					
Chloraprep, 2% applicator	1	1	1	1	1	1			1	1	1
CSR wrap 30 x 30 in.	1	1	1	1	1	1	1	1	1	1	1
Drape, blue, with 4 in. fenestration	1	1	1	1	1	1	1	1	1	1	1
Dressing, transparent, 4 x 4¾ in.	1	1	1		1	1					
Dry sponge stick 6 in.							2	2			
Foam needle block	1	1	1	1	1	1	1		1	1	1
Gauze, 3 x 3 in., 12-ply							3	3	3	1	6
Gauze, 4 x 4 in., 8-ply	10	10	10	10	10	10					
Labels, 5/sheet	1	1	1	1	1	1			1	1	1
Lidocaine, 2%, glass ampule, 10 mL	2	2	2	2	2	2	2	2	1	2	2
Marker, fine tip, utility	1	1	1	1	1	1			1	1	1
Needle protector									2	2	2
Stopcock, 3 way, male, luer slip		1	1		1		1	1			
Stopcock, 4 way, large bore, 50 PSI, swivel				1		1					
Surical blade, #11, safety, stainless steel	1	1	1	1	1	1			1	1	1
Syringe, luer lock, 5 mL	1	1	2		1	1	1	1			
Syringe, luer lock, 10 mL				1					1		1
Syringe, luer lock, 30 mL	1	1		1	1	1					
Syringe, luer lock, 60 mL					1		1	1	1	1	1
Towel, white 17 x 18 in.	1	1	1	1	1	1	1	1	1	1	1
Tubing for vacuum bottle, 16G x 1½ in. needle	1	1	1		1	1	1	1	1	1	1
Tubing, large bore, 48 in., luer non-vented spike and clamp				1							
Vial with cap, clear #1, 8 mL		1	1	1	1		1	3	1	1	1
Vial with cap, clear #2, 8 mL		1	1	1	1		1		1	1	1
Vial with cap, clear #3, 8 mL		1	1	1	1		1		1	1	1

All products listed on this page are not made with natural rubber latex.

Diagnostic Procedure Trays

Acute Drainage – Paracentesis, Thoracentesis



Safety Offering

	Safety Centesis Tray with Covidien Turkel Safety Fluid Drainage System, 8 Fr X 5 in.	Safety Centesis Tray with Argon, 5 Fr X 4 in. Skater Catheter	Safety Centesis Tray with Merit, 5 Fr Catheter	Safety Centesis Tray with Merit, 5 Fr Catheter And Large Bore Tubing	Safety Centesis Tray with Merit, 8 Fr Catheter	Safety Centesis Tray with no Catheter or Needle	Safety Centesis Tray with Argon Aspiration Needle, 16G X 3 in.	Safety Centesis Tray with Carefusion Aspiration Needle, 16G X 3 in.	Safety Centesis Tray with Argon, 5 Fr Straight Drainage Catheter	Safety Centesis Tray with Covidien Turkel Safety Fluid Drainage System, 8 Fr X 5 in.	Safety Centesis Tray with Covidien Turkel Safety Fluid Drainage System, 8 Fr X 5 in.
Cat. No. with Drug	30-CE1SF	30-CE2SFA	30-CE2SMA	30-CE2SF5F	30-CE2SF8F	30-CE3SF	30-CE5CS	30-CE5SF	30-CE6SF	30-CE6CSF	30-CE8SF
Cat. No. without Drug	30-CE1SDF	30-CE2SFAF	30-CE2SMADF	30-CE2SF5D		30-CE3SDF	30-CE5CSDF	30-CE5SDF	30-CE6SDF	30-CE6CSDF	30-CE8SDF
Case Quantity	10	10	10	10	10	10	10	10	10	10	10
Carefusion Cross Reference	TPT1000SP	OTP5000	OTP5000				4340AS	4340AS	TPT1005	TPT1005SP	TPT1000SP
Argon Cross Reference	ATPT1000SP						A4340AS	A4340AS	ATPT1005	ATPT1005SP	ATPT1000SP
Merit Cross Reference				TAPS-5F-10LT							

Core components page 23 Plus below

BD Needle, hypodermic, safety, 22G x 1½ in.	1	1	1	1	1	1	1	1	1	1	1
BD Needle, hypodermic, safety, 25G x ¾ in.	1	1									
BD Needle, hypodermic, safety, 25G x 1 in.									1	1	1
BD Needle, hypodermic, safety, 25G x 1½ in.			1	1	1	1	1	1			
Catheter adapter ⅛ to ¼ in.		1	1	1	1	1			1	1	1
Catheter, Argon straight centesis, 5 Fr x 4 in. with stopcock and ball valve									1		
Catheter, Argon straight centesis, 5 Fr x 4 in. w/o stopcock or ball valve		1									
Catheter, Merit straight centesis, 5 Fr x 4 in. w/o stopcock or ball valve			1	1							
Catheter, Covidien Turkel, straight centesis, 8 Fr x 5 in., Safety with stopcock and ball valve	1									1	1
Catheter, Merit straight centesis, 8 Fr x 5 in. w/o stopcock or ball valve					1						
FILTER STRAW®, 5 micron, 1¾ in.	1	1	1	1	1	1			1	1	1
Needle, aspiration, 16G x 3 in.							1	1			

All products listed on this page are not made with natural rubber latex.

Diagnostic Procedure Trays

Acute Drainage – Paracentesis, Thoracentesis



Safety Offering

	Safety Centesis Tray with Argon, 8 Fr x 5 in. Catheter	Safety Centesis Tray with Covidien Turkel Safety Fluid Drainage System, 8 Fr x 5 in.	Safety Centesis Tray with Covidien Turkel Safety Fluid Drainage System, 8 Fr x 5 in.	Centesis Tray with Merit Pigtail, 6 Fr x 12 cm Catheter	Safety Centesis Tray with Merit Pigtail, 6 Fr x 12 cm Catheter	Centesis Tray with Merit Pigtail, 8 Fr x 12 cm Catheter	Safety Centesis Tray with Merit Pigtail, 8 Fr x 12 cm Catheter
Cat. No. with Drug	30-CE8SA	30-CE9SF	30-CE11SF	30-CE15CO	30-CE16SF	30-CE17CO	30-CE18SF
Cat. No. without Drug	30-CE8SADF	30-CE9SFDF	30-CE11SDF		30-CE16SFD		30-CE18SFD
Case Quantity	10	10	9	16	16	16	14
Carefusion Cross Reference	TPT1000SP	TPT1000SP	TPT1000SP	PIG1260K	PIG1260TSP	PIG1280K	PIG1280TSP
Argon Cross Reference	ATPT1000SP	ATPT1000SP	ATPT1000SP	APIG1260K	APIG1260TSP	APIG1280K	APIG1280TSP
Merit Cross Reference				TAPS-5F-10LT			

Core Components included in Paracentesis, Thoracentesis trays – see page 26 for additional components

Adhesive bandage, ¾ x 3 in.	1	1	1		1		1
Bag, fluid collection, 2000 mL	1	1	1		1		1
Bag, drainage, tubing set, with 2 check valves	1	1	1		1		1
Cap, male/female, luer-lock adapter				1	1	1	1
Chloraprep, 2% applicator	1	1	1		1		1
CSR wrap 30 x 30 in.	1	1	1		1		1
Drape, blue, with 4 in. fenestration	1	1	1		1		1
Foam needle block	1	1	1		1		1
Gauze, 3 x 3 in., 12-ply	6	6	6		6		
Gauze, 4 x 4 in., 8-ply							6
Labels, 5/sheet	1	1	1		1		1
Lidocaine, 2%, glass ampule, 10 mL	2	2	2		2		2
Marker, fine tip, utility	1		1				
Needle protector	1		2	1		1	
Stopcock, 3 way, male, luer slip				1	1	1	1
Stopcock, 4 way, large bore, 50 PSI, swivel			1				
Surical blade, #11, safety, stainless steel	1	1		1	1	1	1
Syringe, luer lock, 10 mL	1	1	1		1		1
Syringe, luer lock, 60 mL	1	1	1		1		1
Towel, white 17 x 18 in.	1	1	1		1		1
Tubing for vacuum bottle, 16G x 1½ in. needle	1	1	1	1	1	1	1
Vial with cap, clear #1, 8 mL	1	1	1		1		1
Vial with cap, clear #2, 8 mL	1	1	1		1		1
Vial with cap, clear #3, 8 mL	1	1	1		1		1

All products listed on this page are not made with natural rubber latex.

Diagnostic Procedure Trays

Acute Drainage – Paracentesis, Thoracentesis



Safety Offering

	Safety Centesis Tray with Argon, 8 Fr x 5 in. Catheter	Safety Centesis Tray with Covidien Turkel Safety Fluid Drainage System, 8 Fr x 5 in.	Safety Centesis Tray with Covidien Turkel Safety Fluid Drainage System, 8 Fr x 5 in.	Centesis Tray with Merit Pigtail, 6 Fr x 12 cm Catheter	Safety Centesis Tray with Merit Pigtail, 6 Fr x 12 cm Catheter	Centesis Tray with Merit Pigtail, 8 Fr x 12 cm Catheter	Safety Centesis Tray with Merit Pigtail, 8 Fr x 12 cm Catheter
Cat. No. with Drug	30-CE8SA	30-CE9SF	30-CE11SF	30-CE15CO	30-CE16SF	30-CE17CO	30-CE18SF
Cat. No. without Drug	30-CE8SADF	30-CE9SFDF	30-CE11SFDF		30-CE16SFD		30-CE18SFD
Case Quantity	10	10	9	16	16	16	14
Carefusion Cross Reference	TPT1000SP	TPT1000SP	TPT1000SP	PIG1260K	PIG1260TSP	PIG1280K	PIG1280TSP
Argon Cross Reference	ATPT1000SP	ATPT1000SP	ATPT1000SP	APIG1260K	APIG1260TSP	APIG1280K	APIG1280TSP
Merit Cross Reference				TAPS-5F-10LT			

Core components page 25 Plus below

BD Needle, filter 19G x 1½ in.		1					
BD Precision Glide® needle, 22G x 1½ in.					1		1
BD Needle, hypodermic, safety, 22G x 1½ in.	1	1	1				
BD Precision Glide® needle, 25G x ½ in.					1		1
BD Needle, hypodermic, 25G x 1 in.	1						
BD Needle, hypodermic, safety, 25G x 1 in.			1				
BD Needle, hypodermic, safety, 25G x 1½ in.		1					
Catheter adapter ⅛ to ⅜ in.	1		1		1		1
Catheter, Covidien Turkel, straight centesis, 8 Fr x 5 in., safety with stopcock and ball valve		1	1				
Catheter, Argon, straight centesis, 8 Fr, safety with stopcock and ball valve	1						
Catheter, Merit pigtail centesis, 6 Fr x 12 cm					1		
Catheter, Merit pigtail centesis, 8 Fr x 12 cm						1	1
FILTER STRAW®, 5 micron, 1¾ in.	1		1		1		1

All products listed on this page are not made with natural rubber latex.

Diagnostic Procedure Trays

Acute Drainage – Peritoneal Lavage



Lazarus Nelson Peritoneal Lavage Tray

Conventional Offering

Cat. No. with Drug	99-LN1CO
Cat. No. without Drug	
Case Quantity	10
Carefusion Cross Reference	LNT9000

Components included in Peritoneal Lavage tray	
Adhesive bandage, fabric, ¾ x 3 in.	1
BD hypodermic needle, 21G x 1½ in.	1
BD Precision Glide® hypodermic needle, 25G x ⅝ in.	1
BD Precision Glide® hypodermic needle, 20G x 1½ in.	1
Catheter, peritoneal lavage set includes Radiopaque Lazarus-Nelson catheter, 9 Fr x 6 in., flexible guidewire, straight tip, needle 18G x 3 in.	1
CSR wrap, 30 x 30 in.	1
Drape, white, 18 x 18 in.	1
Gauze, non-woven, 3 x 3 in. 4-ply	3
PVP-I swabsticks, 3 pack	1
Surgical blade, #11, with plastic handle	1
Syringe, luer lock, 5 mL	1
Syringe, luer lock, 10 mL	1
Towel, white, poly lined, 17 x 18 in.	1

All products listed on this page are not made with natural rubber latex.

Diagnostic Procedure Trays

Bone Marrow Biopsy



Conventional Offering

	Bone Marrow Biopsy with Argon Standard 11G x 4 in. J-Type Needle	Bone Marrow Biopsy with Argon Standard 11G x 4 in. J-Type and 15G I-Type Needles	Bone Marrow Biopsy with Argon Standard 15G I-Type Needle	Bone Marrow Biopsy No Needle	Bone Marrow Biopsy with Argon Standard 8G x 4 in. J-Type and 15G I-Type Needles	Bone Marrow Biopsy with Argon Standard 15G x 4 in. I-Type Needle	Bone Marrow Biopsy with Argon Standard 18G x 1 1/2 in. J-Type Needle
Cat. No. with Drug	31-BM1CO	31-BM2CO	31-BM3CO	31-BM4CO	31-BM6CO	31-BM8CO	99-BM1CO
Cat. No. without Drug	31-BM1CODF	31-BM2CODF	31-BM3CODF	31-BM4CODF	31-BM6CODF	31-BM8CODF	99-BM1CODF
Case Quantity	10	10	10	10	10	10	10
Carefusion Cross Reference	BAK3411	BAK4511	BAK2015	BK1000	BAK4508	BAT3018	

Core Components included in Bone Marrow Biopsy trays – see page 32 for additional components

Adhesive bandage, fabric, 3/4 x 3 in.	1	1	1	1	1	1	
BD Precision Glide® filter needle, 19G x 1 1/2 in.	1	1	1	1	1		
BD Precision Glide® hypodermic needle, 20G x 1 1/2 in.							1
BD Precision Glide® hypodermic needle, 21G x 1 1/2 in.							1
BD Precision Glide® hypodermic needle, 22G x 1 1/2 in.	1	1	1	1	1	1	
BD Precision Glide® hypodermic needle, 25G x 5/8 in.	1	1	1	1	1	1	1
Blood collection tube, 4 mL						2	
Blood collection tube, 6 mL							2
Cap, luer lock cap	1	1			1	1	
ChloraPrep®, 2% applicator	1	1	1	1	1	1	
CSR wrap, 30 x 30 in.	1	1	1	1	1	1	1
Drape, blue, 18 x 24 in. with 4 in. fenestration	1	1	1	1	1	1	1
Elastic stretch bandage, 2 in. x 5 yd.							1
Foam needle block	1	1	1	1	1	1	
Gauze, 3 x 3 in., 12-ply							5
Gauze, 4 x 4 in., 8-ply	10	10	10	10	10	10	
Labels, 5/sheet	1	1	1	1	1	1	
Lidocaine, 2%, glass ampule, 10 mL	2	2	2	2	2	1	1
Marker, fine tip, utility	1	1	1	1	1		
Microscope slide, double frosted, 3 x 1 in.							10
Microscope slide, frosted, 3 x 1 in.						10	
PVP-I swabsticks, 3/pack							1
Specimen container, 4 1/2 in., with screw lid							1
Stir rod						1	1
Surgical scalpel, #11							1
Surgical scalpel, #11, safety, stainless steel	1	1	1	1	1	1	
Syringe, luer lock, 5 mL						1	1
Syringe, luer lock, 10 mL	1	1	1	1	1		
Syringe, luer lock, 20 mL	1	1	1	1	1	1	1
Towel, white, poly lined, 17 x 18 in.	1	1	1	1	1	1	1

All products listed on this page are not made with natural rubber latex.

Diagnostic Procedure Trays

Bone Marrow Biopsy



Conventional Offering

	Bone Marrow Biopsy with Argon Standard 11G x 4 in. J-Type Needle	Bone Marrow Biopsy with Argon Standard 11G x 4 in. J-Type and 15G I-Type Needles	Bone Marrow Biopsy with Argon Standard 15G I-Type Needle	Bone Marrow Biopsy No Needle	Bone Marrow Biopsy with Argon Standard 8G x 4 in. J-Type and 15G I-Type Needles	Bone Marrow Biopsy with Argon Standard 15G x 4 in. I-Type Needle	Bone Marrow Biopsy with Argon Standard 18G x 1½ in. J-Type Needle
Cat. No. with Drug	31-BM1CO	31-BM2CO	31-BM3CO	31-BM4CO	31-BM6CO	31-BM8CO	99-BM1CO
Cat. No. without Drug	31-BM1CODF	31-BM2CODF	31-BM3CODF	31-BM4CODF	31-BM6CODF	31-BM8CODF	99-BM1CODF
Case Quantity	10	10	10	10	10	10	10
Carefusion Cross Reference	BAK3411	BAK4511	BAK2015	BK1000	BAK4508	BAT3018	

Core components page 31 Plus below

Argon Extraction cannula					1		
Argon Obturator, 8G x 5 ¹⁵ / ₁₆ in.					1		
Argon Obturator, 11G x 6 in.	1	1					
Argon Probe guide	1	1					
Argon Standard needle, bone marrow biopsy, 18G x 1½ in.							1
Argon Standard needle, bone marrow biopsy, J-Type, 8G x 4 in.					1		
Argon Standard needle, bone marrow biopsy, J-Type, 11G x 4 in.	1	1					
Argon Standard needle, bone marrow biopsy, I-Type, 15G x 2 in.		1	1		1		
Argon Standard needle, bone marrow biopsy, I-Type, 15G x 4 in.						1	

All products listed on this page are not made with natural rubber latex.

Diagnostic Procedure Trays

Bone Marrow Biopsy



Conventional Offering

	Bone Marrow Biopsy with Argon Premium 13G x 2 1/2 in. J-Type Needle	Bone Marrow Biopsy with Argon Standard 15G I-Type Needle	Bone Marrow Biopsy No Needle	Bone Marrow Biopsy with Argon Standard 15G I-Type Needle	HealthTrust Bone Marrow Biopsy with Argon Premium 11G x 4 in. J-Type Needle	Biopsy with Argon Premium 11G x 4 in. J-Type, and 15G I-Type Needles	Bone Marrow Biopsy with Argon Premium 8G x 4 in. J-Type and 15G I-Type Needles
Cat. No. with Drug	99-BM2CO	99-BM3CO	99-BM4CO	99-BM7CO	HT31-BM1CO	HT31-BM2CO	HT31-BM6CO
Cat. No. without Drug	99-BM2CODF	99-BM3CODF	99-BM4CODF	99-BM7CODF	HT31-BM1CDF	HT31-BM2CDF	HT31-BM6CDF
Case Quantity	10	10	10	10	10	10	10
Carefusion Cross Reference	BCT3513						

Core Components included in Bone Marrow Biopsy trays – see page 34 for additional components

Adhesive bandage, fabric, 3/4 x 3 in.	1		1	1	1	1	1
BD Precision Glide® filter needle, 19G x 1 1/2 in.					1	1	1
BD Precision Glide® hypodermic needle, 20G x 1 1/2 in.	1	1	1	1			
BD Precision Glide® hypodermic needle, 21G x 1 1/2 in.	1	1	1	1			
BD Precision Glide® hypodermic needle, 22G x 1 1/2 in.					1	1	1
BD Precision Glide® hypodermic needle, 25G x 5/8 in.		1			1	1	1
BD Precision Glide® hypodermic needle, 25G x 1 1/2 in.	1		1	1			
Blood collection tube, 6 mL	2	2	2				
Cap, luer lock	1				1	1	1
Chloraprep®, 2% applicator					1	1	1
CSR wrap, 30 x 30 in.	1	1	1	1	1	1	1
Drape, blue, 18 x 24 in. with 4 in. fenestration	1	1	1	1	1	1	1
Elastic stretch bandage, 2 in. x 5 yd.		1					
Foam needle block					1	1	1
Gauze, 3 x 3 in., 12-ply	5	5	5	8			
Gauze, 4 x 4 in., 8-ply					10	10	10
Labels, 5/sheet					1	1	1
Labels, specimen	1						
Lid, specimen, snap	1	1	1				
Lidocaine, 2%, glass ampule, 10 mL	2	1	2	1	2	2	2
Marker, fine tip, utility					1	1	1
Microscope slide, double frosted, 3 x 1 in.		10					
Microscope slide, frosted, 3 x 1 in.	10		10				
PVP-I swabsticks, 3/pack	1	1	1	1			
Specimen container	1	1	1				
Specimen container, 4 1/2 in., with screw lid	1		1				
Stir rod	1	1	1				
Surgical scalpel, #11, safety	1		1		1	1	1

All products listed on this page are not made with natural rubber latex.

Diagnostic Procedure Trays

Bone Marrow Biopsy



Conventional Offering

	Bone Marrow Biopsy with Argon Premium 13G x 2 1/2 in. J-Type Needle	Bone Marrow Biopsy with Argon Standard 15G I-Type Needle	Bone Marrow Biopsy No Needle	Bone Marrow Biopsy with Argon Standard 15G I-Type Needle	HealthTrust Bone Marrow Biopsy with Argon Premium 11G x 4 in. J-Type Needle	Biopsy with Argon Premium 11G x 4 in. J-Type, and 15G I-Type Needles	Bone Marrow Biopsy with Argon Premium 8G x 4 in. J-Type and 15G I-Type Needles
Cat. No. with Drug	99-BM2CO	99-BM3CO	99-BM4CO	99-BM7CO	HT31-BM1CO	HT31-BM2CO	HT31-BM6CO
Cat. No. without Drug	99-BM2CODF	99-BM3CODF	99-BM4CODF	99-BM7CODF	HT31-BM1CDF	HT31-BM2CDF	HT31-BM6CDF
Case Quantity	10	10	10	10	10	10	10
Carefusion Cross Reference	BCT3513						

Core Components included in Bone Marrow Biopsy trays – continued from page 33

Syringe tip, non vented	2		2				
Syringe, luer lock, 5 mL	1	1	1	1			
Syringe, luer lock, 10 mL					1	1	1
Syringe, luer lock, 20 mL		1			1	1	1
Syringe, luer slip, 10 mL	1	1	1				
Syringe, luer slip, 20 mL	1		1	1			
Towel, white, poly lined, 17 x 18 in.	1	1	1	1	1	1	1

Core components page 33–34 Plus below

Argon Extraction cannula						1	
Argon Needle, obturator, 11G x 6 in.					1	1	
Argon Premium needle, bone marrow biopsy, J-Type, 11G x 4 in.					1	1	
Argon Premium needle, bone marrow biopsy, 11G x 5 in.							1
Argon Premium needle, bone marrow biopsy, J-Type, 13G x 2 1/2 in.	1						
Argon Premium needle, bone marrow biopsy, 14G x 5 in.					1	1	
Argon Premium needle, bone marrow biopsy, 15G x 2 1/8 in.						1	1
Argon Premium needle, bone marrow biopsy, J-Type, 8G x 4 in.							1
Argon Probe guide	1				1	1	1
Argon Probe, obturator, 8G x 5 1/8 in.							1
Argon Probe, obturator, 13G x 4 1/2 in.	1						
Argon Standard needle, bone marrow biopsy, I-Type, 15G x 2 in.		1		1			

All products listed on this page are not made with natural rubber latex.

Diagnostic Procedure Trays

Bone Marrow Biopsy



Safety Offering

	Safety Bone Marrow Biopsy with Argon Standard 11G x 4 in. J-Type Needle	Safety Bone Marrow Biopsy with Argon Standard 11G x 4 in. J-Type and 15G I-Type Needles	Safety Bone Marrow Biopsy No Needle	Safety Bone Marrow Biopsy with Argon Standard 8G x 4 in. J-Type and 15G I-Type Needles	Safety Bone Marrow Biopsy with Argon Premium 11G x 4 in. J-Type Needle	Safety Bone Marrow Biopsy with Argon Premium 11G x 4 in. J-Type and 15G I-Type Needles	Safety Bone Marrow Biopsy with Argon Premium 8 x 4 in. J-Type and 15G I-Type Needles
Cat. No. with Drug	31-BM1SF	31-BM2SF	31-BM4SF	31-BM6SF	HT31-BM1SF	HT31-BM2SF	HT31-BM6SF
Cat. No. without Drug	31-BM1SFDF	31-BM2SFDF	31-BM4SFDF	31-BM6SFDF	HT31-BM1SDF	HT31-BM2SDF	HT31-BM6SDF
Case Quantity	10	10	10	10	10	10	10
Carefusion Cross Reference	BCT3411	BCAM4511SP	BK1000SP				

Core Components included in Bone Marrow Biopsy trays

Adhesive bandage, fabric, ¾ x 3 in.	1	1	1	1	1	1	1
BD Precision Glide® hypodermic needle, 25G x ½ in., safety	1	1	1	1	1	1	1
BD Precision Glide® hypodermic needle, 22G x 1½ in., safety	1	1	1	1	1	1	1
Cap, luer lock	1	1		1	1	1	1
ChlorPrep®, 2% applicator	1	1	1	1	1	1	1
CSR wrap, 30 x 30 in.	1	1	1	1	1	1	1
Drape, blue, 18 x 24 in. with 4 in. fenestration	1	1	1	1	1	1	1
Foam needle block	1	1	1	1	1	1	1
Gauze, 4 x 4 in., 8-ply	10	10	10	10	10	10	10
Labels, 5/sheet	1	1	1	1	1	1	1
Lidocaine, 2%, glass ampule, 10 mL	2	2	2	2	2	2	2
Marker, fine tip, utility	1	1	1	1	1	1	1
Surgical scalpel, #11, safety	1	1	1	1	1	1	1
Syringe, luer lock, 10 mL	1	1	1	1	1	1	1
Syringe, luer lock, 20 mL	1	1	1	1	1	1	1
Towel, white, poly lined, 17 x 18 in.	1	1	1	1	1	1	1

Core components Plus below

Argon Extraction cannula	1	1		1			
Argon Obturator, 8G x 5 ¹⁵ / ₁₆ in.				1			1
Argon Obturator, 11G x 6 in.	1	1			1	1	
Argon Premium needle, bone marrow biopsy, J-Type, 11G x 4 in.					1	1	
Argon Premium needle, bone marrow biopsy, 11G x 5 in.							1
Argon Premium needle, bone marrow biopsy, 14G x 5 in.					1	1	
Argon Premium needle, bone marrow biopsy, 15G x 2 ¹ / ₁₆ in.						1	1
Argon Premium needle, bone marrow biopsy, J-Type, 8G x 4 in.							1
Argon Probe guide	1	1		1	1	1	1
Argon Standard needle, bone marrow biopsy, J-Type, 8G x 4 in.				1			
Argon Standard needle, bone marrow biopsy, J-Type, 11G x 4 in.	1	1					
Argon Standard needle, bone marrow biopsy, I-Type, 15G x 2 in.		1		1			
FILTER STRAW®, 5 micron, 1¾ in.	1	1	1	1	1	1	1

All products listed on this page are not made with natural rubber latex.

Diagnostic Procedure Trays

Bone Marrow Biopsy



Premium Conventional Offering

	<i>T-Lok Bone Marrow Biopsy Tray; Includes T-Lok Cannula and 8G x 4 in. T-Lok Needle and 16G Aspiration Needle</i>	<i>T-Lok Bone Marrow Biopsy Tray; Includes T-Lok Cannula and 11G x 4 in. T-Lok Needle</i>	<i>T-Lok Bone Marrow Biopsy Tray; Includes T-Lok Cannula and 11G x 4 in. T-Lok Needle and 16G Aspiration Needle</i>	<i>T-Lok Bone Marrow Biopsy Tray; Includes T-Lok Cannula and 15G Aspiration Needle</i>	<i>T-Lok Bone Marrow Biopsy Tray; Includes T-Lok Cannula and 16G Aspiration Needle</i>	<i>T-Lok Bone Marrow Biopsy Tray; Includes T-Lok Cannula and 8G x 4 in. T-Lok Needle</i>	<i>T-Lok Bone Marrow Biopsy Tray; Includes T-Lok Cannula and 16G Aspiration Needle</i>
Cat. No. with Drug	ET0804TLP	ET1104ATLP	ET1104TLP	HTBMT1501P	HTBMT1601P	T0804ATLP	T0804TLP
Cat. No. without Drug	ET0804TLPF	ET1104ATLF	ET1104TLPD	HTBMT150DF	HTBMT160DF	T0804ATLDF	T0804TLPDF
Case Quantity	10	10	10	10	10	10	10
Argon Cross Reference	BMET0804TL	BMET1104ATL	BMET1104TL	BMT1501	BMT1601	BMT0804ATL	BMET0804TL

Core Components included in Bone Marrow Biopsy trays							
Adhesive bandage, ¾ x 3 in.	1	1	1	1	1	1	1
BD Needle, filter 19G x 1½ in.	1	1	1	1	1	1	1
BD Precision Glide® hypodermic needle, 21G x 1½ in.	1	1	1	1	1	1	1
BD Precision Glide® needle, 25G x ¾ in.	1	1	1	1	1	1	1
Blood collection tube, 4 mL				1	1	1	1
Cap, luer lock	1	1	1			1	1
CSR wrap 30 x 30 in.	1	1	1	1	1	1	1
Drape, blue, 18 x 24 in. with 4 in. fenestration	1	1	1	1	1	1	1
Foam needle block							
Gauze, 3 x 3 in., 12-ply	5	5	5	5	5	5	5
Lidocaine, 2%, glass ampule, 10 mL	1	1	1	1	1	2	2
Microscope slide, frosted, 3 x 1 in.				10	10	10	10
PVP-I swabsticks, 3 pack	1	1	1	1	1	1	1
Specimen container, 4½ in. with snap lid, amber				1	1	1	1
Stir rod				1	1	1	1
Surgical scalpel, #11, thumb	1	1	1	1	1	1	
Surgical scalpel, #11, safety stainless steel							
Syringe, luer lock, 5 mL	1	1	1	1	1	1	1
Syringe, luer lock, 20 mL	1	1	1	1	1	1	1
Towel, white 17 x 18 in.	1	1	1	1	1	1	1
Core components Plus below							
Argon Extraction Cannula	1		1			1	1
Argon Obturator, 8G x 5½ in.	1	1				1	1
Argon Obturator, 11G x 6 in.		1	1				
Argon Probe Guide	1	1	1			1	1
Argon Premium needle, bone marrow biopsy, J-Type 8G x 4 in.						1	1
Argon Premium needle, bone marrow biopsy, J-Type 11G x 4 in.	1	1	1				
Argon Premium needle, bone marrow biopsy, I-Type 15G x 2 in.				1			
Argon Premium needle, bone marrow biopsy, I-Type 16G x 2 in.	1		1		1		1

All products listed on this page are not made with natural rubber latex.

Diagnostic Procedure Trays

Bone Marrow Biopsy



Premium Conventional Offering

	T-Lok Bone Marrow Biopsy Tray; Includes T-Lok Cannula and 1 1G x 4 in. T-Lok Needle	T-Lok Bone Marrow Biopsy Tray; Includes T-Lok Cannula and 1 1G x 4 in. T-Lok Needle and 1 15G Aspiration Needle	T-Lok Bone Marrow Biopsy Tray with Safety Needles; Includes T-Lok Cannula and 11G x 4 in. T-Lok Needle	T-Lok Bone Marrow Biopsy Tray; Includes T-Lok Cannula and 11G x 4 in. T-Lok Needle and 16G Aspiration Needle
Cat. No. with Drug	T1104ATLP	T1104BTLP	T1104STLP	T1104TLP
Cat. No. without Drug	T1104ATLDF	T1104BTLDF	T1104STLPF	T1104TLPDF
Case Quantity	10	10	10	
Argon Cross Reference	BMET1104ATL	BMT1104BTL	BMT1104STL	BMT1104TL

Core Components included in Bone Marrow Biopsy trays				
Adhesive bandage, ¾ x 3 in.	1	1	1	1
BD Needle, filter 19G x 1½ in.	1	1	1	1
BD Precision Glide® hypodermic needle, 21G x 1½ in.	1	1	1	1
BD Precision Glide® needle, 25G x ¾ in.	1	1	1	1
Blood collection tube, 4 mL	2	2	2	2
Cap, luer lock	1	1	1	1
CSR wrap 30 x 30 in.	1	1	1	1
Drape, blue, 18 x 24 in. with 4 in. fenestration	1	1	1	1
Foam needle block			1	
Gauze, 3 x 3 in., 12-ply	5	5	5	5
Lidocaine, 2%, glass ampule, 10 mL	1	1	1	1
Microscope slide, frosted, 3 x 1 in.	10	10	10	10
PVP-I swabsticks, 3 pack	1	1	1	1
Specimen container, 4½ in. with snap lid, amber	1	1	1	1
Stir rod	1	1	1	1
Surgical scalpel, #11, thumb	1	1		1
Surgical scalpel, #11, safety stainless steel			1	
Syringe, luer lock, 5 mL	1	1	1	1
Syringe, luer lock, 20 mL	1	1	1	1
Towel, white 17 x 18 in.	1	1	1	1
Core components Plus below				
Argon Extraction Cannula	1	1	1	1
Argon Obturator, 11G x 6 in.	1	1	1	1
Argon Obturator, 8G x 5½ in.				
Argon Probe Guide	1	1	1	1
Argon Premium needle, bone marrow biopsy, J-Type 8G x 4 in.				
Argon Premium needle, bone marrow biopsy, J-Type 11G x 4 in.	1	1	1	1
Argon Premium needle, bone marrow biopsy, I-Type 15G x 2 in.		1		
Argon Premium needle, bone marrow biopsy, I-Type 16G x 2 in.				1

All products listed on this page are not made with natural rubber latex.

Diagnostic Procedure Trays

Bone Marrow Biopsy



Standard Conventional Offering

T-Lok Bone Marrow Biopsy Tray; Includes T-Lok Cannula and 8G x 4 in. T-Lok Needle and 16G Aspiration Needle

T-Lok Bone Marrow Biopsy Tray; Includes T-Lok Cannula and 11G x 4 in. T-Lok Needle

T-Lok Bone Marrow Biopsy Tray; Includes T-Lok Cannula and 11G x 4 in. T-Lok Needle and 16G Aspiration Needle

T-Lok Bone Marrow Biopsy Tray; Includes T-Lok Cannula and 15G Aspiration Needle

T-Lok Bone Marrow Biopsy Tray; Includes T-Lok Cannula and 16G Aspiration Needle

T-Lok Bone Marrow Biopsy Tray; Includes T-Lok Cannula and 8G x 4 in. T-Lok Needle

T-Lok Bone Marrow Biopsy Tray; Includes T-Lok Cannula and 16G Aspiration Needle

Cat. No. with Drug	ET0804TLS	ET1104ATLS	ET1104TLS	HTBMT1000	HTBMT1501S	T0804ATLS	T0804TLS
Cat. No. without Drug	ET0804TLSD	ET1104ATDF	ET1104TSLD	HTBMT100DF	HTBMT151DF	T0804ATLSF	T0804TSLDF
Case Quantity	10	10	10	10	10	10	10
Argon Cross Reference	ET0804TLP	ET1104ATLP	ET1104TLP	BMT1000	HTBMT1501P	T0804ATLP	T0804TLP

Core Components included in Bone Marrow Biopsy trays							
Adhesive bandage, ¾ x 3 in.	1	1	1	1	1	1	1
BD Needle, filter 19G x 1½ in.	1	1	1	1	1	1	1
BD Precision Glide® hypodermic needle, 21G x 1½ in.	1	1	1	1	1	1	1
BD Precision Glide® needle, 25G x ½ in.	1	1	1	1	1	1	1
Blood collection tube, 4 mL				2	2	2	2
Cap, luer lock	1	1	1			1	1
CSR wrap 30 x 30 in.	1	1	1	1	1	1	1
Drape, blue, 18 x 24 in. with 4 in. fenestration	1	1	1	1	1	1	1
Foam needle block							
Gauze, 3 x 3 in., 12-ply	5	5	5	5	5	5	5
Lidocaine, 2%, glass ampule, 10 mL	1	1	1	2	1	2	2
Microscope slide, frosted, 3 x 1 in.				10	10	10	10
PVP-I swabsticks, 3 pack	1	1	1	1	1	1	1
Specimen container, 4½ in. with snap lid, amber				1	1	1	1
Stir rod				1	1	1	1
Surgical scalpel, #11, thumb	1	1	1	1	1	1	1
Surgical scalpel, #11, safety stainless steel							
Syringe, luer lock, 5 mL	1	1		1	1	1	1
Syringe, luer lock, 20 mL	1	1	1	1	1	1	1
Towel, white 17 x 18 in.	1	1	1	1	1	1	1
Core components Plus below							
Argon Extraction Cannula	1	1	1			1	1
Argon Obturator, 8G x 5 ¹⁵ / ₁₆ in.	1					1	1
Argon Obturator, 11G x 6 in.		1	1				
Argon Probe Guide	1	1	1			1	1
Argon Standard needle, bone marrow biopsy, J-Type 8G x 4 in.	1					1	1
Argon Standard needle, bone marrow biopsy, J-Type 11G x 4 in.		1	1				
Argon Standard needle, bone marrow biopsy, I-Type 15G x 2 in.	1		1		1		

All products listed on this page are not made with natural rubber latex.

Diagnostic Procedure Trays

Bone Marrow Biopsy



T-Lok Bone Marrow Biopsy Tray;
Includes T-Lok Cannula and
11G x 4 in. T-Lok Needle

T-Lok Bone Marrow Biopsy Tray;
Includes T-Lok Cannula and
11G x 4 in. T-Lok Needle And
15G Aspiration Needle

T-Lok Bone Marrow Biopsy Tray
with Safety Needles; Includes
T-Lok Cannula and 11G x 4 in.
T-Lok Needle

T-Lok Bone Marrow Biopsy Tray;
Includes T-Lok Cannula and
11G x 4 in. T-Lok Needle and
16G Aspiration Needle

Standard Conventional Offering

	Cat. No. with Drug	T1104ATLS	T1104BTLS	T1104STLS	T1104TSL
	Cat. No. without Drug	T1104ATLSF	T1104BTSDF	T1104STLSF	T1104TSLDF
	Case Quantity	10	10	10	10
	Argon Cross Reference	T1104ATLP	T1104BTLP	T1104STLP	T1104TLP

Core Components included in Bone Marrow Biopsy trays

Adhesive bandage, ¾ x 3 in.	1	1	1	1
BD Needle, filter 19G x 1½ in.	1	1	1	1
BD Precision Glide® hypodermic needle, 21G x 1½ in.	1	1	1	1
BD Precision Glide® needle, 25G x ½ in.	1	1	1	1
Blood collection tube, 4 mL	2	2	2	2
Cap, luer lock	1	1	1	1
CSR wrap 30 x 30 in.	1	1	1	1
Drape, blue, 18 x 24 in. with 4 in. fenestration	1	1	1	1
Foam needle block			1	
Gauze, 3 x 3 in., 12-ply	5	5	5	5
Lidocaine, 2%, glass ampule, 10 mL	1	1	1	1
Microscope slide, frosted, 3 x 1 in.	10	10	10	10
PVP-I swabsticks, 3 pack	1	1	1	1
Specimen container, 4½ in. with snap lid, amber	1	1	1	1
Stir rod	1	1	1	1
Surgical scalpel, #11, thumb	1	1		1
Surgical scalpel, #11, safety stainless steel			1	
Syringe, luer lock, 5 mL	1	1	1	1
Syringe, luer lock, 20 mL	1	1	1	1
Towel, white 17 x 18 in.	1	1	1	1

Core components Plus below

Argon Extraction Cannula	1	1	1	1
Argon Obturator, 8G x 5¼ in.				
Argon Obturator, 11G x 6 in.	1	1	1	1
Argon Probe Guide	1	1	1	1
Argon Standard needle, bone marrow biopsy, J-Type 8G x 4 in.				
Argon Standard needle, bone marrow biopsy, J-Type 11G x 4 in.	1	1	1	1
Argon Standard needle, bone marrow biopsy, I-Type 15G x 2 in.		1		1

All products listed on this page are not made with natural rubber latex.

Diagnostic Procedure Trays

Soft Tissue Biopsy



Conventional and Safety Offering

	Safety Soft Tissue Biopsy	Soft Tissue Biopsy	Safety Soft Tissue Biopsy	Soft Tissue Biopsy Tray with Carefusion Menghini Needle 16G x 4 in.	Soft Tissue Biopsy Tray with Argon 16G x 3 in. Needle	Soft Tissue Biopsy Tray with Argon 16G x 4 in. Needle	Jamshidi Menghini Biopsy Tray with Argon 16G x 4 in. Needle	Jamshidi Menghini Biopsy Tray with Argon 16G x 3 in. Needle	Jamshidi Menghini Biopsy Tray with Argon 18G x 3 in. Needle
Cat. No. with Drug	32-4162	32-ST1CO	32-ST1SF	32-ST2CO	99-ST3CO	99-ST4CO	HTSK1015A	HTSK7015A	HTSK7017A
Cat. No. without Drug	32-4162DF	32-ST1CODF	32-ST1SFDF	32-ST2CODF	99-ST3CODF	99-ST4CODF	HTSK1015AF	HTSK7015AF	HTSK7017AF
Case Quantity	30	10	10	10	10	10	10	10	10
Carefusion Cross Reference		4380	4382ASP	SK1016A			SK1015A	SK7015A	SK7017A

Core Components included in Soft Tissue Biopsy trays									
Adhesive bandage, fabric, ¾ x 3 in.		1	1	1	1	1	1	1	1
Adhesive bandage, plastic, 1 x 3 in.	1								
Alcohol prep pad	1								
BD arterial needle, 18G x 1½ in.		1	1						
BD hypodermic needle, 18G x 1½ in.	1								
BD hypodermic needle, 21G x 1½ in.				1			1	1	1
BD hypodermic needle, 21G x 1½ in.					1	1			
BD hypodermic needle, 25G x ¾ in.			1						
BD hypodermic needle, safety, 20G x 1½ in.				1			1	1	1
BD hypodermic needle, safety, 22G x 1½ in.			1						
BD hypodermic needle, safety, 25G x ¾ in.				1			1	1	1
Cannula, marrow extraction				1			1	1	1
Cap, male/female, luer-lock adapter		1	1						
ChloroPrep®, 2% applicator		1	1						
CSR wrap, 30 x 30 in.		1	1		1	1			
Drape, 18 x 26 in. with fenestration	1								
Drape, blue, 18 x 24 in. with 4 in. fenestration		1	1		1	1			
Drape, white, 18 x 18 in.				1			1	1	1
Drape, white, 18 x 26 in.				1			1	1	1
Foam needle block		1	1						
Gauze, 3 x 3 in., 12-ply	5			3			3	3	3
Gauze, 4 x 4 in., 8-ply		10	10		3	3			
Labels, 5/sheet		1	1						
Labels, specimen				1			1	1	1
Lid, specimen, snap				1			1	1	1
Lidocaine, 2%, glass ampule, 10 mL	1	1	1	1	1	1	1	1	1
Marker, fine tip, utility		1	1						
Needle protector				1			1	1	1
Needle, special 16G x 1½ in.				1			1	1	1

All products listed on this page are not made with natural rubber latex.

Diagnostic Procedure Trays

Soft Tissue Biopsy



Conventional and Safety Offering

	Safety Soft Tissue Biopsy	Soft Tissue Biopsy	Safety Soft Tissue Biopsy	Soft Tissue Biopsy Tray with Carefusion Menghini Needle 16G X 4 in.	Soft Tissue Biopsy Tray with Argon 16G X 3 in. Needle	Soft Tissue Biopsy Tray with Argon 16G x 4 in. Needle	Jamshidi Menghini Biopsy Tray with Argon 16G x 4 in. Needle	Jamshidi Menghini Biopsy Tray with Argon 16G x 3 in. Needle	Jamshidi Menghini Biopsy Tray with Argon 18G x 3 in. Needle
Cat. No. with Drug	32-4162	32-ST1CO	32-ST1SF	32-ST2CO	99-ST3CO	99-ST4CO	HTSK1015A	HTSK7015A	HTSK7017A
Cat. No. without Drug	32-4162DF	32-ST1CODF	32-ST1SFDF	32-ST2CODF	99-ST3CODF	99-ST4CODF	HTSK1015AF	HTSK7015AF	HTSK7017AF
Case Quantity	30	10	10	10	10	10	10	10	10
Carefusion Cross Reference		4380	4382ASP	SK1016A			SK1015A	SK7015A	SK7017A

Core Components included in Soft Tissue Biopsy trays – continued from page 40

One-compartment tray	1								
Protector pouch, single pocket	1								
PVP-I swabsticks, 3 pack	1			1	1	1	1	1	1
Ruler, 6 in., flexible	1	1	1						
Sodium chloride, 0.9%, glass ampule 5 mL				1	1	1	1	1	1
Specimen container				1			1	1	1
Surgical mini blade #11	1								
Surgical thumb blade #11				1			1	1	1
Surgical blade, #11, safety, stainless steel		1	1		1	1			
Syringe, luer lock, 3 mL		1	1						
Syringe, luer lock, 5 mL		1	1		1	1			
Syringe, luer lock, 10 mL	2								
Syringe, luer lock, 20 mL	1	1	1						
Syringe, luer slip, 5 mL				1	1	1	1	1	1
Syringe, luer slip, 10 mL				1			1	1	1
Towel, absorbent	1								
Towel, white, poly lined, 17 x 18 in.		1	1		1	1			
Towel, white, poly lined, 28 x 28 in.				1			1	1	1
Vial with cap, clear #1, 8 mL		1	1		1	1			
Vial with cap, clear #2, 8 mL		1	1		1	1			
Wrap, polyback, flat, 28 x 28 in.	1								

Core components pages 40–41 Plus below

Argon Needle, echogenic biopsy, 16G x 3 in.					1			1	
Argon Needle, echogenic biopsy, 16G x 4 in.						1	1		
Argon Needle, echogenic biopsy, 18G x 4 in.									1
BD Precision Glide® filter needle, 19G X 1½ in.		1		1			1	1	1
BD Precision Glide® hypodermic needle, 20G x 1½ in.					1	1			
BD Precision Glide® hypodermic needle, 22G x 1½ in.	1	1							
BD Precision Glide® hypodermic needle, 25G x ¾ in.	1	1			1	1			
CareFusion needle, aspiration 16G x 3 in.				1					
FILTER STRAW®, 5 micron, 1¾ in.			1						

All products listed on this page are not made with natural rubber latex.

Diagnostic Procedure Trays

Basic

Basic



Basic Diagnostic Tray

Conventional Offering

Cat. No. with Drug	33-BA1CO
Cat. No. without Drug	33-BA1CODF
Case Quantity	10
Carefusion Cross Reference	N/A

Components included in Basic tray	
Adhesive bandage, fabric, ¾ x 3 in.	1
BD Precision Glide® BD hypodermic needle needle, 22G x 1½ in.	1
BD Precision Glide® BD hypodermic needle needle, 25G x 5⁄8 in.	1
BD Precision Glide® filter needle, 19G x 1½ in.	1
ChloroPrep®, 2% applicator	1
CSR wrap, 30 x 30 in.	1
Drape, blue, 18 x 24 in. with 4 in. fenestration	1
Foam needle block	1
Gauze, 4 x 4 in., 8-ply	10
Labels, 5/sheet	1
Lidocaine, 2%, glass ampule, 10 mL	1
Marker, fine tip, utility	1
Surical blade, #11, safety, stainless steel	1
Syringe, luer lock, 5 mL	1
Towel, white, poly lined, 17 x 18 in.	1

All products listed on this page are not made with natural rubber latex.

Diagnostic Procedure Trays

Paracervical/Pudendal Block



Paracervical/Pudendal Block Tray
with 10 mL Control Syringe,
20G x 6 in. Spinal Needle

Paracervical/Pudendal Block Tray
with 20 mL Control Syringe,
20G x 6 in. Spinal Needle

	Cat. No.	99-PC3CO	99-PC4CO
Case Quantity		10	20
Carefusion Cross Reference		4540A	4542

Core Components included in Paracervical/Pudendal Block trays			
BF303009	BD Precision Glide® BD hypodermic needle, 22G x 1½ in.	1	1
A4024	CSR wrap, 24 x 24 in.	1	1
C-NWS444	Gauze, non-woven, 4 x 4 in., 4-ply	2	2
47-612A	Needle with slip, 20G x 6 in.	1	1
304134LF	Syringe, luer lock, 10cc	1	
81-520178B	Syringe, luer lock, 20cc		1
FG74-131D	Trumpet needle guide assembly	1	1
UPSMD1724	Underpad, 24 x 17 in., moderate	1	1

All products listed on this page are not made with natural rubber latex.

Gastroenterology Endoscopy Kits

Endo Scope Clean and Setup Kits



Endo Scope Clean Kit

Case Quantity: 36

Cat. No.	Contents	Quantity
END99ESCKB	Double-ended channel brush, 2-4 mm	1
	Gauze, 4 x 4 in., 8-ply	10
	HR® 1.25 oz. lube	1
	Padded, scope transport bag with drawstrings	1
	Scope Valet™ ECO-Bedside kit with sponge, biodegradable* container with lid	1

Endo Setup Kit

Case Quantity: 36

Cat. No.	Contents	Quantity
END99ESUKB	Gauze, 4 x 4 in., 8-ply	10
	HR® 1.25 oz. lube	1
	Padded, scope transport bag with drawstrings	1
	Scope Valet™ ECO-Bedside kit with sponge, biodegradable* container with lid	1
	Suction tubing, 6 mm x 6 ft.	1

*Tray and lid are certified OK bio-based, OK compost, biodegradable and tested to meet ASTM D6400 and EN-13432. 90% biodegradation is achieved within 180 days.

[Watch the Endoscopy Video in the GI Lab on cardinalhealth.com to learn more about our endoscopy kits.](#)

All products listed on this page are not made with natural rubber latex.

Minor Procedure Trays

Debridement Trays



Debridement Tray

Case Quantity: 20

Cat. No.	Contents	Quantity
04-0100A	Alcohol prep pad	1
	Cotton tip applicator, 6 in.	1
	CSR, 20 x 20 in.	1
	Gauze, 3 x 3 in.	2
	Instrument, forceps, Adson tissue, 4¾ in., 1 x 2 teeth	1
	Instrument, scissors, Iris, 4½ in., straight	1
	One-compartment tray	1
	Surgical scalpel, #15, safety	1



Debridement Tray

Case Quantity: 20

Cat. No.	Contents	Quantity
04-0300A	CSR, 20 x 20 in.	1
	Exam gloves, large walled, pair	1
	Gauze, 3 x 3 in., 12-ply	15
	Instrument, forceps, Adson tissue, 4¾ in., 1 x 2 teeth	1
	Instrument, forceps, Halstead Mosquito, 5 in., curved	1
	Instrument, scissors, Iris, 4½ in., straight	1
	One-compartment tray	1
	Plastic bag	1
	Surgical scalpel, #15, safety	1
	Towels, blue, scrim	2



Debridement Tray

Case Quantity: 20

Cat. No.	Contents	Quantity
04-0200A	Cotton tip applicator, 6 in.	1
	CSR, 20 x 20 in.	1
	Exam gloves, large walled, pair	2
	Gauze, 3 x 3 in.	5
	Instrument, forceps, Adson tissue, 4¾ in., 1 x 2 teeth	1
	Instrument, scissors, Iris, 4½ in., straight	1
	Ruler, 6 in., flexible	1
	Surgical scalpel, #15, safety	1
	Swabstick, PVP-I, single	1
	Towel, blue, scrim	1

All products listed on this page are not made with natural rubber latex.

Minor Procedure Trays

Incision and Drainage Trays



Incision and Drainage Tray

Case Quantity: 20

Cat. No.	Contents	Quantity
24006-010	Alcohol prep pad	1
	Drape, poly backed, fenestrated, 13½ x 18 in.	1
	Gauze, 4 x 4 in.	4
	Instrument, Kelly hemostat, straight, 5½ in.	1
	Instrument, wire forceps, 5 in.	1
	Plastic bag	1
	PVP-I prep pad	1
	Surgical blade, #11, with plastic handle	1
	Towels, white, absorbent	1



Incision and Drainage Tray

Case Quantity: 20

Cat. No.	Contents	Quantity
25006-010	Alcohol prep pad	1
	Drape, poly backed, fenestrated, 13½ x 18 in.	1
	Gauze, 4 x 4 in.	4
	Instrument, wire forceps, 4-5 in.	1
	Kelly forceps, straight, 5½ in.	1
	Plastic bag	1
	PVP-I prep pad	1
	Surgical blade, #11, with plastic handle	1
	Towels, white, absorbent	1

Incision and Drainage Tray

Case Quantity: 20

Cat. No.	Contents	Quantity
25006-040	Alcohol prep pad	1
	Drape, poly backed, fenestrated, 13½ x 18 in.	1
	Gauze, 4 x 4 in.	4
	Instrument, operating scissors, sharp/blunt, straight	1
	Instrument, wire forceps, 4-5 in.	1
	Kelly forceps, straight, 5½ in.	1
	Plastic bag	1
	PVP-I prep pad	1
	Surgical blade, #11, with plastic handle	1
	Towels, white, absorbent	1



Incision and Drainage Tray

Case Quantity: 10

Cat. No.	Contents	Quantity
08-0002	Drape, fenestrated, 15 x 25 in.	1
	Gauze, 4 x 4 in.	8
	Instrument, forceps, Adson tissue, 4¾ in., 1 x 2 teeth	1
	Instrument, forceps, Halstead Mosquito, 5 in., curved	1
	Instrument, probe, 5½ in., with eye	1
	Instrument, scissors, operating, 5½ in., straight, sharp/blunt	1
	PVP-I prep pad	2
	Surgical blade, #11, safety, stainless steel	1
	Towel, blue, scrim	1

All products listed on this page are not made with natural rubber latex.

Minor Procedure Trays

Instruments – All Purpose Instrument Trays

AMER All Purpose Instrument Tray

Case Quantity: 20

Cat. No.	Contents	Quantity
24008-020	Alcohol prep pad	1
	Cotton tip applicator, 3 in., plastic	2
	Gauze, 3 x 3 in.	2
	Instrument, Kelly hemostat, straight, 5½ in.	1
	Instrument, scissors, wire, sharp/blunt, 5½ in.	1
	Instrument, wire forceps, 5 in.	1
	PVP-I prep pad	1
	Safety pin, 1½ in.	1

AM Stainless A-P Sterile Tray

Case Quantity: 20

Cat. No.	Contents	Quantity
25008-020	Alcohol prep pad	1
	Cotton tip applicator, 3 in., plastic	2
	Gauze, 3 x 3 in.	2
	Instrument, operating scissors, sharp/blunt, straight	1
	Instrument, wire forceps, 4-5 in.	1
	Kelly forceps, straight, 5½ in.	1
	PVP-I prep pad	1
	Safety pin, 1½ in.	1

AMER All Purpose Instrument Tray

Case Quantity: 20

Cat. No.	Contents	Quantity
24008-030	Alcohol prep pad	1
	Cotton tip applicator, 3 in., plastic	2
	Gauze, 3 x 3 in.	2
	Instrument, hemostat Mosquito, wire, curved, 5 in.	1
	Instrument, scissors, dressing, wire, 4½ in.	1
	Instrument, wire forceps, 5 in.	1
	PVP-I prep pad	1
	Safety pin, 1½ in.	1

AM Stainless A-P Sterile Tray

Case Quantity: 20

Cat. No.	Contents	Quantity
25008-030	Alcohol prep pad	1
	Cotton tip applicator, 3 in., plastic	2
	Gauze, 3 x 3 in.	2
	Instrument, forceps, Halstead Mosquito, 5 in., curved	1
	Instrument, scissors, Iris, 4½ in., straight with tip protector	1
	Instrument, wire forceps, 4-5 in.	1
	PVP-I prep pad	1
	Safety pin, 1½ in.	1

AMER All Purpose Instrument Tray

Case Quantity: 20

Cat. No.	Contents	Quantity
24008-040	Alcohol prep pad	1
	Cotton tip applicator, 3 in., plastic	2
	Gauze, 3 x 3 in.	2
	Instrument, hemostat Mosquito, wire, straight, 5 in.	1
	Instrument, scissors, dressing, wire, 4½ in.	1
	Instrument, wire forceps, 5 in.	1
	PVP-I prep pad	1
	Safety pin, 1½ in.	1

AM Stainless A-P Sterile Tray

Case Quantity: 20

Cat. No.	Contents	Quantity
25008-040	Alcohol prep pad	1
	Cotton tip applicator, 3 in., plastic	2
	Gauze, 3 x 3 in.	2
	Instrument, forceps, Halstead Mosquito, 5 in., straight	1
	Instrument, scissors, Iris, 4½ in., straight with tip protector	1
	Instrument, wire forceps, 4-5 in.	1
	PVP-I prep pad	1
	Safety pin, 1½ in.	1

AM Stainless A-P Sterile Tray

Case Quantity: 20

Cat. No.	Contents	Quantity
25008-010	Alcohol prep pad	1
	Cotton tip applicator, 3 in., plastic	2
	Gauze, 3 x 3 in.	2
	Instrument, Kelly forceps, curved, 5½ in.	1
	Instrument, operating scissors, sharp/blunt, straight	1
	Instrument, wire forceps, 4-5 in.	1
	PVP-I prep pad	1
	Safety pin, 1½ in.	1

Instrument Tray

Case Quantity: 50

Cat. No.	Contents	Quantity
NI15-0057	Gauze, 4 x 4 in.	2
	Instrument, forceps, thumb dressing, serrated, 5½ in.	1
	Instrument, Kelly forceps, curved, 5½ in.	1
	Instrument, operating scissors, sharp/sharp, straight, 5½ in.	1
	Instrument tip protector	1

All products listed on this page are not made with natural rubber latex.

Minor Procedure Trays

Instruments – Single, Sterile

Circumcision Clamp

Cat. No.	Description	Quantity
SSI-0034	Gomco circumcision clamp, chrome plated, 1.1 cm	10/cs
SSI-0035	Gomco circumcision clamp, chrome plated, 1.3 cm	10/cs

Forceps

Cat. No.	Description	Quantity
NI16-1100	Adson tissue forceps, 1 x 2 teeth	50/cs
SSI-0027	Adson tissue forceps, 1:2 teeth, satin, 4¾ in.	50/cs
16-2400	Adson tissue forceps, serrated, straight, 4¾ in.	50/cs
16-1800	Clamp tube, occluding, 7 in., straight, smooth jaw, with tape	50/cs
SSI-0051	Crile forcep, curved, serrated, 5½ in.	50/cs
16-1019	Foerster sponge forcep, serrated, straight, 9½ in.	50/cs
SSI-0042	Foerster sponge forcep, serrated, straight, satin, 9½ in.	50/cs
16-1200	Halstead mosquito hemostat, curved, polished, 5 in.	50/cs
16-1700	Halstead mosquito hemostat, straight, polished, 5 in.	50/cs
SSI-0009	Halstead mosquito hemostat, straight, satin, 5 in.	50/cs
SSI-0012	Halstead mosquito hemostat, fine tip, curved, satin, 5 in.	50/cs
SSI-0011	Halstead mosquito hemostat with tip protector, curved, satin, 5 in.	50/cs
16-1007A	Hartman alligator forceps, serrated, satin, 3½ in.	50/cs
33048-010A	Insertion forcep, serrated, wire, 5 in.	50/cs
SSI-0048	Lucae bayonet ear forcep, serrated, 5½ in.	50/cs
33048-004A	Kelly hemostat, curved, 5½ in.	50/cs
16-1002	Kelly hemostat, curved, polished, 5½ in.	50/cs
SSI-0015	Kelly hemostat, curved, satin, 5½ in.	50/cs
16-1001	Kelly hemostat, straight, polished, 5½ in.	50/cs
SSI-0013	Kelly hemostat, straight, satin, 5½ in.	50/cs
33048-002A	Kelly hemostat, straight, wire, 5½ in.	50/cs
NI16-1037	Plastic sponge forcep, serrated, straight, green, 9½ in.	50/cs
BN16-2800	Rochester-pean hemostat, curved, polished, 6¼ in.	50/cs
SSI-0049	Splinter forcep, fine tip, straight, serrated, 4½ in.	50/cs
SSI-0024	Thumb dressing forcep, serrated, 5½ in., satin	50/cs
SSI-0024	Thumb dressing forcep, serrated, wire, 5½ in.	50/cs
SSI-0050	Thumb dressing forcep, straight, serrated, 5½ in.	50/cs
NI16-3100B	Transfer forcep, serrated, plastic, 5 in.	50/cs

Miscellaneous

Cat. No.	Description	Quantity
SSI-0046	Dilator probe with eye, blunt tip, satin, 5 ½ in.	50/cs
16-1014	Wire cutter, 4 ¾ in, angled	20/cs

Needle Holders

Cat. No.	Description	Quantity
16-0001	Baumgartner needle holder, serrated jaw, polished, 5½ in.	50/cs
SSI-0044	Baumgartner needle holder, serrated jaw, satin, 5 in.	50/cs
33048-006A	Baumgartner needle holder, serrated jaw, wire, 5 in.	50/cs
16-0006A	Mayo-hegar needle holder, serrated jaw, polished, 6 in.	50/cs
SSI-0043	Mayo-hegar needle holder with tip protector, serrated jaw, polished, 8 in.	50/cs
16-1600	Webster needle holder, smooth jaw, large ring, satin, 5 in.	50/cs
SSI-0017	Webster needle holder, smooth jaw, large ring, polished, 4¾ in.	50/cs
SSI-0018	Webster needle holder, smooth jaw, large ring, polished, 5 in.	50/cs
SSI-0022	Webster needle holder with tip protector, smooth jaw, large ring, polished, 6 in.	50/cs
SSI-0021	Webster needle holder with tip protector, smooth jaw, large ring, fine tip, 6 in.	50/cs

Scissors

Cat. No.	Description	Quantity
NI16-1044	Iris scissor with tip protector, curved, polished, 4½ in.	50/cs
SSI-0038	Iris scissors, curved, 4½ in., satin	50/cs
16-3200	Iris scissor with tip protector, straight, satin, 4½ in.	50/cs
16-1000	Iris scissor with tip protector, straight, polished, 4½ in.	50/cs
SSI-0004	Iris scissor with tip protector, straight, satin, 4½ in.	50/cs
16-2700	Lister bandage scissor, angled nodule/blunt, polished, 5½ in.	50/cs
BN16-1018	Lister bandage scissor, angled nodule/blunt, polished, 7¼ in.	50/cs
SSI-0008	Lister bandage scissor with tip protector, angled nodule/blunt, satin, 5½ in.	50/cs
33048-020A	Littauer scissor, straight hook/blunt, wire, 4½ in.	50/cs
SSI-0006	Littauer scissor, straight hook/blunt, large ring, satin, 4½ in.	50/cs
SSI-0039	Operating scissor, blunt/blunt, straight, satin, 5½ in.	50/cs
16-1021	Operating scissor, sharp/blunt, straight, polished, 5½ in.	50/cs
NI-IS38	Operating scissor, sharp/blunt, straight, polished, 4½ in.	50/cs
SSI-0002	Operating scissor, sharp/blunt, straight, satin, 4½ in.	50/cs
16-1003	Operating scissor with tip protector, sharp/blunt, straight, polished, 5½ in.	50/cs
33048-150A	Operating scissor, sharp/blunt, wire, 5½ in.	50/cs
33048-045A	Operating scissor, sharp/sharp, straight, wire, 4½ in.	50/cs
SSI-0003	Operating scissor, sharp/blunt, straight, satin, 5½ in.	50/cs
SSI-0052	Dissecting mayo scissors, blunt/blunt, straight, 6¾ in.	50/cs
SSI-0054	Metzenbaum scissors, blunt/blunt, curved, 7 in.	50/cs
SSI-0053	Dissecting mayo scissors, blunt/blunt, straight, 5 ½ in.	50/cs

Staple Remover

Cat. No.	Description	Quantity
16-1028	Stapler remover, 4 in.	50/cs

Vaginal Speculum

Cat. No.	Description	Quantity
S1024	Clear vaginal speculum, medium	20/cs
SSI-0029	Graves vaginal speculum, medium	20/cs
SSI-0032	Pederson vaginal speculum, medium	20/cs

All products listed on this page are not made with natural rubber latex.

Minor Procedure Trays

Laceration Trays

Kit Number	05-5200	05-5410	05-5800	05-6000	05-7566	25004-010	25004-020	25004-040	ACS-S-LAC1	ACS-S-LAC2	ACS-S-LAC4	ACS-S-SAF1	ACS-S-SAF2	NI05-0173	NI05-0174
Case Quantity	20	20	20	20	20	20	20	20	20	20	20	20	20	30	20
PACKAGING															
CSR wrap	1	1	1	1	1				1	1	1	1	1	1	1
One-compartment tray			1						1	1		1	1	1	
Two-compartment tray		1													1
Three-compartment tray	1			1	1						1				
DRAPES															
Drape, 2 x 3 in., oval fenestration, blue cloth				1							1				
Drape, 2¾ in., round fenestration, white	1	1	1		1				1	1		1	1	1	1
Drape, 4 in., fenestration, poly backed						1	1	1							
INSTRUMENTS															
Instrument, forceps, Adson tissue, 4¾ in., straight, 1 x 2 teeth	1	1	1	1	1	1	1	1	1	1		1	1	1	
Instrument, forceps, Adson tissue, 4¾ in., straight, 1 x 2 teeth, satin											1				
Instrument, forceps, Adson tissue, 4¾ in., straight, serrated jaw															1
Instrument, forceps, Halstead Mosquito, 5 in., curved, serrated jaw	1	1	1	1	1			1	1	1		1	1		
Instrument, forceps, Halstead Mosquito, 5 in., curved, serrated jaw, satin											1				
Instrument, forceps, Halstead Mosquito, 5 in., straight, serrated jaw														1	
Instrument, forceps, Kelly, 5½ in., curved, serrated jaw								1							
Instrument, needle holder, Baumgartner, 5½ in., serrated jaw						1	1			1					
Instrument, needle holder, Webster, 4¾ in., smooth jaw															1
Instrument, needle holder, Webster, 5 in., smooth jaw	1	1	1		1						1				
Instrument, needle holder, Webster, 5 in., smooth jaw, large rings								1	1			1	1	1	
Instrument, needle holder, Webster, 5 in., smooth jaw, large rings, satin				1											
Instrument, scissors, Iris, 4½ in., curved, sharp/sharp				1											
Instrument, scissors, Iris, 4½ in., straight, sharp/sharp	1	1	1		1				1	1		1	1	1	1
Instrument, scissors, Iris, 4½ in., straight, sharp/sharp, satin											1				
Instrument, scissors, Iris, 4½ in., straight, sharp/sharp, with tip protector								1							
Instrument, scissors, operating, 5½ in., straight, sharp/blunt						1	1								
MISCELLANEOUS															
Cotton tip applicators, 6 in., plastic	2				4										
Gauze, 2 x 2 in.	5	5	5						5	5	5	5	5		
Gauze, 4 x 4 in.	10	10	10	10	10	4	4	4	10	10	10	10	10	8	10
Irrigation splash guard															1
Labels, blank, white, waterproof	2	2	2						2	2	2	2	2		
Medicine cups, 2 oz.	2	2	2		2				2	2	2	2	2	2	
Refuse bag with tie						1	1	1							
NEEDLES and SYRINGES															
Needle, 18G x 1½ in.	1	1							1	1	1				
Needle, 18G x 1½ in., safety													1		
Needle, 20G x 1 in.				1											
Needle, 25G x ¾ in.	1	1		1					1	1	1				
Needle, 25G x ¾ in., safety													1		
Needle, 27G x 1¼ in.				1											
Needle, 27G x 1½ in.	1	1							1	1	1				
Needle, 30G x ¾ in.															
Syringe, control, luer lock, 10 mL															
Syringe, luer lock, 10 mL	1	1		1					1	1	1	1	1		
Syringe, luer lock, 20 mL															1
SOLUTIONS and DRUGS															
Alcohol prep pad						1	1	1							
Lidocaine, 1%, glass ampule, 10 mL															
PVP-I prep pad						1	1	1							
TOWELS															
Towels, blue, cotton		2		1							2				
Towels, blue, scrim	2		2						2	2		2	2		2
Towels, white					2	1	1	1						1	

All products listed on this page are not made with natural rubber latex.

Minor Procedure Trays

Laceration Trays – One-Compartment Tray



Laceration Tray

Case Quantity: 20

Cat. No.	Contents	Quantity
05-5800	CSR wrap	1
	Drape, 2¾ in., round fenestration, white	1
	Gauze, 2 x 2 in.	5
	Gauze, 4 x 4 in.	10
	Instrument, forceps, Adson tissue, 4¾ in., straight, 1 x 2 teeth	1
	Instrument, forceps, Halstead Mosquito, 5 in., curved, serrated jaw	1
	Instrument, needle holder, Webster, 5 in., smooth jaw	1
	Instrument, scissors, Iris, 4½ in., straight, sharp/sharp	1
	Labels, blank, white, waterproof	2
	Medicine cups, 2 oz.	2
	One-compartment tray	1
	Towels, blue, scrim	2

Laceration Tray

Case Quantity: 20

Cat. No.	Contents	Quantity
ACS-S-LAC1	CSR wrap	1
	Drape, 2¾ in., round fenestration, white	1
	Gauze, 2 x 2 in.	5
	Gauze, 4 x 4 in.	10
	Instrument, forceps, Adson tissue, 4¾ in., straight, 1 x 2 teeth	1
	Instrument, forceps, Halstead Mosquito, 5 in., curved, serrated jaw	1
	Instrument, needle holder, Webster, 5 in., smooth jaw, large rings	1
	Instrument, scissors, Iris, 4½ in., straight, sharp/sharp	1
	Labels, blank, white, waterproof	2
	Medicine cups, 2 oz.	2
	Needle, 18G x 1½ in.	1
	Needle, 25G x ⅝ in.	1
	Needle, 27G x 1½ in.	1
	One-compartment tray	1
	Syringe, luer lock, 10 mL	1
	Towels, blue, scrim	2

All products listed on this page are not made with natural rubber latex.

Minor Procedure Trays

Laceration Trays – One-Compartment Tray



Laceration Tray

Case Quantity: 20

Cat. No.	Contents	Quantity
ACS-S-LAC2	CSR wrap	1
	Drape, 2¾ in., round fenestration, white	1
	Gauze, 2 x 2 in.	5
	Gauze, 4 x 4 in.	10
	Instrument, forceps, Adson tissue, 4¾ in., straight, 1 x 2 teeth	1
	Instrument, forceps, Halstead Mosquito, 5 in., curved, serrated jaw	1
	Instrument, needle holder, Baumgartner, 5½ in., serrated jaw	1
	Instrument, scissors, Iris, 4½ in., straight, sharp/sharp	1
	Labels, blank, white, waterproof	2
	Medicine cups, 2 oz.	2
	Needle, 18G x 1½ in.	1
	Needle, 25G x ⅝ in.	1
	Needle, 27G x 1½ in.	1
	One-compartment tray	1
	Syringe, luer lock, 10 mL	1
	Towels, blue, scrim	2

Laceration Tray

Case Quantity: 20

Cat. No.	Contents	Quantity
ACS-S-SAF1	CSR wrap	1
	Drape, 2¾ in., round fenestration, white	1
	Gauze, 2 x 2 in.	5
	Gauze, 4 x 4 in.	10
	Instrument, forceps, Adson tissue, 4¾ in., straight, 1 x 2 teeth	1
	Instrument, forceps, Halstead Mosquito, 5 in., curved, serrated jaw	1
	Instrument, needle holder, Webster, 5 in., smooth jaw, large rings	1
	Instrument, scissors, Iris, 4½ in., straight, sharp/sharp	1
	Labels, blank, white, waterproof	2
	Medicine cups, 2 oz.	2
	One-compartment tray	1
	Syringe, luer lock, 10 mL	1
	Towels, blue, scrim	2

All products listed on this page are not made with natural rubber latex.

Minor Procedure Trays

Laceration Trays – One-Compartment Tray



Laceration Tray

Case Quantity: 20

Cat. No.	Contents	Quantity
ACS-S-SAF2	CSR wrap	1
	Drape, 2¾ in., round fenestration, white	1
	Gauze, 2 x 2 in.	5
	Gauze, 4 x 4 in.	10
	Instrument, forceps, Adson tissue, 4¾ in., straight, 1 x 2 teeth	1
	Instrument, forceps, Halstead Mosquito, 5 in., curved, serrated jaw	1
	Instrument, needle holder, Webster, 5 in., smooth jaw, large rings	1
	Instrument, scissors, Iris, 4½ in., straight, sharp/sharp	1
	Labels, blank, white, waterproof	2
	Medicine cups, 2 oz.	2
	Needle, 18G x 1½ in., safety	1
	Needle, 25G x 5⁄8 in., safety	1
	One-compartment tray	1
	Syringe, luer lock, 10 mL	1
	Towels, blue, scrim	2

Laceration Tray

Case Quantity: 30

Cat. No.	Contents	Quantity
NI05-0173	CSR wrap	1
	Drape, 2¾ in., round fenestration, white	1
	Gauze, 4 x 4 in.	8
	Instrument, forceps, Adson tissue, 4¾ in., straight, 1 x 2 teeth	1
	Instrument, forceps, Halstead Mosquito, 5 in., straight, serrated jaw	1
	Instrument, needle holder, Webster, 5 in., smooth jaw, large rings	1
	Instrument, scissors, Iris, 4½ in., straight, sharp/sharp	1
	Medicine cups, 2 oz.	2
	One-compartment tray	1
	Towel, white	1

All products listed on this page are not made with natural rubber latex.

Minor Procedure Trays

Laceration Trays – Two-Compartment Tray



Laceration Tray

Case Quantity: 20

Cat. No.	Contents	Quantity
05-5410	CSR wrap	1
	Drape, 2¾ in., round fenestration, white	1
	Gauze, 2 x 2 in.	5
	Gauze, 4 x 4 in.	10
	Instrument, forceps, Adson tissue, 4¾ in., straight, 1 x 2 teeth	1
	Instrument, forceps, Halstead Mosquito, 5 in., curved, serrated jaw	1
	Instrument, needle holder, Webster, 5 in., smooth jaw	1
	Instrument, scissors, Iris, 4½ in., straight, sharp/sharp	1
	Labels, blank, white, waterproof	2
	Medicine cups, 2 oz.	2
	Needle, 18G x 1½ in.	1
	Needle, 25G x ¾ in.	1
	Needle, 27G x 1½ in.	1
	Syringe, luer lock, 10 mL	1
	Towels, blue, cotton	2
	Two-compartment tray	1

Laceration Tray

Case Quantity: 20

Cat. No.	Contents	Quantity
NI05-0174	CSR wrap	1
	Drape, 2¾ in., round fenestration, white	1
	Gauze, 4 x 4 in.	10
	Instrument, forceps, Adson tissue, 4¾ in., straight, serrated jaw	1
	Instrument, forceps, Halstead Mosquito, 5 in., curved, serrated jaw	1
	Instrument, needle holder, Webster, 4¾ in., smooth jaw	1
	Instrument, scissors, Iris, 4½ in., straight, sharp/sharp	1
	Irrigation splash guard	1
	Syringe, luer lock, 20 mL	1
	Towels, blue, scrim	2
	Two-compartment tray	1

All products listed on this page are not made with natural rubber latex.

Minor Procedure Trays

Laceration Trays – Three-Compartment Tray



Laceration Tray

Case Quantity: 20

Cat. No.	Contents	Quantity
05-5010	CSR wrap	1
	Drape, 2¾ in., round fenestration, white	1
	Gauze, 2 x 2 in.	5
	Gauze, 4 x 4 in.	10
	Instrument, forceps, Adson tissue, 4¾ in., straight, 1 x 2 Teeth	1
	Instrument, needle holder, Webster, 5 in., smooth jaw	1
	Instrument, scissors, Iris, 4½ in., straight, sharp/sharp	1
	Lidocaine, 1%, glass ampule, 10 mL	1
	Needle, 18G x 1½ in.	1
	Needle, 27G x 1½ in.	1
	Needle, 30G x ¾ in.	1
	Syringe, control, luer lock, 10 mL	1
	Three-compartment tray	1
	Towels, blue, cotton	2

Laceration Tray

Case Quantity: 20

Cat. No.	Contents	Quantity
05-5200	Cotton tip applicators, 6 in., plastic	2
	CSR wrap	1
	Drape, 2¾ in., round fenestration, white	1
	Gauze, 2 x 2 in.	5
	Gauze, 4 x 4 in.	10
	Instrument, forceps, Adson tissue, 4¾ in., straight, 1 x 2 teeth	1
	Instrument, forceps, Halstead Mosquito, 5 in., curved, serrated jaw	1
	Instrument, needle holder, Webster, 5 in., smooth jaw	1
	Instrument, scissors, Iris, 4½ in., straight, sharp/sharp	1
	Labels, blank, white, waterproof	2
	Medicine cups, 2 oz.	2
	Needle, 18G x 1½ in.	1
	Needle, 25G x ⅝ in.	1
	Needle, 27G x 1½ in.	1
	Syringe, luer lock, 10 mL	1
	Three-compartment tray	1
	Towels, blue, scrim	2

All products listed on this page are not made with natural rubber latex.

Minor Procedure Trays

Laceration Trays – Three-Compartment Tray



Laceration Tray

Case Quantity: 20

Cat. No.	Contents	Quantity
05-6000	CSR wrap	1
	Drape, 2 x 3 in., oval fenestration, blue cloth	1
	Gauze, 4 x 4 in.	10
	Instrument, forceps, Adson tissue, 4¾ in., straight, 1 x 2 teeth	1
	Instrument, forceps, Halstead Mosquito, 5 in., curved, serrated jaw	1
	Instrument, needle holder, Webster, 5 in., smooth jaw, large rings, satin	1
	Instrument, scissors, Iris, 4½ in., curved, sharp/sharp	1
	Needle, 20G x 1 in.	1
	Needle, 25G x ⅝ in.	1
	Needle, 27G x 1¼ in.	1
	Syringe, luer lock, 10 mL	1
	Three-compartment tray	1
	Towel, blue, cotton	1

Laceration Tray

Case Quantity: 20

Cat. No.	Contents	Quantity
05-7566	Cotton tip applicators, 6 in., plastic	4
	CSR wrap	1
	Drape, 2¾ in., round fenestration, white	1
	Gauze, 4 x 4 in.	10
	Instrument, forceps, Adson tissue, 4¾ in., straight, 1 x 2 teeth	1
	Instrument, forceps, Halstead Mosquito, 5 in., curved, serrated jaw	1
	Instrument, needle holder, Webster, 5 in., smooth jaw	1
	Instrument, scissors, Iris, 4½ in., straight, sharp/sharp	1
	Medicine cups, 2 oz.	2
	Three-compartment tray	1
	Towels, white	2

All products listed on this page are not made with natural rubber latex.

Minor Procedure Trays

Laceration Trays – Three-Compartment Tray, Laceration Tray with Prep



Laceration Tray

Case Quantity: 20

Cat. No.	Contents	Quantity
ACS-S-LAC4	CSR wrap	1
	Drape, 2 x 3 in., oval fenestration, blue cloth	1
	Gauze, 2 x 2 in.	5
	Gauze, 4 x 4 in.	10
	Instrument, forceps, Adson tissue, 4¾ in., straight, 1 x 2 teeth, satin	1
	Instrument, forceps, Halstead Mosquito, 5 in., curved, serrated jaw, satin	1
	Instrument, needle holder, Webster, 5 in., smooth jaw	1
	Instrument, scissors, Iris, 4½ in., straight, sharp/sharp, satin	1
	Labels, blank, white, waterproof	2
	Medicine cups, 2 oz.	2
	Needle, 18G x 1½ in.	1
	Needle, 25G x ⅝ in.	1
	Needle, 27G x 1½ in.	1
	Syringe, luer lock, 10 mL	1
	Three-compartment tray	1
	Towels, blue, cotton	2

Laceration Tray with Prep

Case Quantity: 20

Cat. No.	Contents	Quantity
25004-010	Alcohol prep pad	1
	Drape, 4 in., fenestration, poly backed	1
	Gauze, 4 x 4 in.	4
	Instrument, forceps, Adson tissue, 4¾ in., straight, 1 x 2 teeth	1
	Instrument, needle holder, Baumgartner, 5½ in., serrated jaw	1
	Instrument, scissors, operating, 5½ in., straight, sharp/blunt	1
	PVP-I prep pad	1
	Refuse bag with tie	1
	Towel, white	1

All products listed on this page are not made with natural rubber latex.

Minor Procedure Trays

Laceration Tray with Prep



Laceration Tray with Prep

Case Quantity: 20

Cat. No.	Contents	Quantity
25004-020	Alcohol prep pad	1
	Drape, 4 in., fenestration, poly backed	1
	Gauze, 4 x 4 in.	4
	Instrument, forceps, Adson tissue, 4¾ in., straight, 1 x 2 teeth	1
	Instrument, forceps, Kelly, 5½ in., curved, serrated jaw	1
	Instrument, needle holder, Baumgartner, 5½ in., serrated jaw	1
	Instrument, scissors, operating, 5½ in., straight, sharp/blunt	1
	PVP-I prep pad	1
	Refuse bag with tie	1
	Towel, white	1

Laceration Tray with Prep

Case Quantity: 20

Cat. No.	Contents	Quantity
25004-040	Alcohol prep pad	1
	Drape, 4 in., fenestration, poly backed	1
	Gauze, 4 x 4 in.	4
	Instrument, forceps, Adson tissue, 4¾ in., straight, 1 x 2 teeth	1
	Instrument, forceps, Halstead Mosquito, 5 in., curved, serrated jaw	1
	Instrument, needle holder, Webster, 5 in., smooth jaw, large rings	1
	Instrument, scissors, Iris, 4½ in., straight, sharp/sharp, with tip protector	1
	PVP-I prep pad	1
	Refuse bag with tie	1
	Towel, white	1

All products listed on this page are not made with natural rubber latex.

Minor Procedure Trays

Respiratory Care Trays – Chest Tube Insertion, Tracheostomy



Chest Tube Insertion Tray

Case Quantity: 10

Cat. No.	Contents	Quantity
12-0203	Connector, straight, 5 in 1, 3/16 to 7/16 in. diameter	1
	Connector, Y, 18 mm length	1
	CSR wrap	1
	Gauze, 4 x 4 in.	12
	Instrument, forceps, Adson tissue, 4 3/4 in., straight, 1 x 2 teeth	1
	Instruments, forceps, Kelly, 5 1/2 in., curved, serrated jaw	2
	Instrument, forceps, Kelly, 7 1/4 in., curved, serrated jaw	1
	Instruments, forceps, Kelly, 8 in., curved, serrated jaw	2
	Instrument, needle holder, mayo hegar, 7 in., serrated jaw	1
	Instrument, scissors, dissecting mayo, 6 3/4 in., curved, blunt/blunt	1
	Instrument, scissors, operating, 5 1/2 in., straight, sharp/sharp	1
	Needle, 20G x 1 1/2 in.	1
	Needle, 25G x 5/8 in.	1
	Needle, spinal, 22G x 3 1/2 in.	1
	Petrolatum dressing, 3 x 18 in.	1
	Scalpel, #11, stainless steel	1
	Suture, silk, black braided, 18 in., circle needle, 4-0	1
	Syringe, luer lock, 10 mL	1
	Towels, blue, cotton	4
	Trays, one-compartment	2
	Tray, instrument	1

Tracheostomy Care Tray

Case Quantity: 20

Cat. No.	Contents	Quantity
11-0006	Cotton tip applicators, 6 in., plastic	3
	Exam gloves, medium walled, pair	1
	Gauze, 4 x 4 in.	3
	Hydrogen peroxide, 3%, foil pouches, 1 oz.	2
	Pipe cleaners	3
	Sponge, Sorb-It®, drain, 4 x 4 in., 6-ply, 2/pk	1
	Three-compartment tray	1
	Towel, 13 x 19 in., poly lined	1
	Trach brush, medium	1
	Trach sponge, foam, 6 x 1 1/2 in.*	1
	Twil, 36 in.	1

*Not pictured

All products listed on this page are not made with natural rubber latex.

Minor Procedure Trays

Respiratory Care Trays – Tracheostomy, Tracheotomy



Tracheostomy Care Tray

Case Quantity: 20

Cat. No.	Contents	Quantity
11-1100	Cotton tip applicators, 6 in., plastic	2
	Exam gloves, medium, pair	2
	Gauze, 4 x 4 in.	4
	Instrument, forceps, plastic	1
	Pipe cleaners	6
	Three-compartment tray	1
	Towels, 13 x 19 in., poly lined	2
	Trach brush, medium	1
	Trach dressing, 4 x 4 in.	1
	Twill, 36 in.	1

Tracheotomy Tray

Case Quantity: 10

Cat. No.	Contents	Quantity
11-0022	Clamps, towel, 2½ in. plastic, white, curved	4
	Gauze, 4 x 4 in.	25
	Instrument trays	2
	Instrument, automatic skin retractor, 4 prong, blunt teeth	1
	Instrument, dilator, Trousseau, trach, 5¼ in.	1
	Instrument, forceps, Adson tissue, 4¾ in., 1 x 2 teeth, fine point, satin	1
	Instrument, forceps, Adson tissue, 4¾ in., serrated jaw, satin	1
	Instrument, forceps, allison tissue, 6 in., 4 x 5 teeth	4
	Instrument, forceps, foerster, 7 in., straight, serrated jaw	1
	Instrument, forceps, Halstead Mosquito, 5 in., curved, serrated jaw, satin	2
	Instrument, forceps, Kelly hemostat, 5½ in., curved, serrated jaw, satin	2
	Instrument, forceps, Kelly hemostat, 5½ in., straight, serrated jaw, satin	2
	Instrument, forceps, thumb dressing, 5½ in., straight, serrated jaw	1
	Instrument, hook, jackson	1
	Instrument, needle holder, Webster, 5 in., smooth jaw, large rings, satin	1
	Instrument, retractor, Weitlander, 6½ in., blunt	1
	Instrument, scissors, Littauer, 4½ in., small	1
	Instrument, scissors, mayo, 6¾ in., straight	1
	Instrument, scissors, metz, 5½ in., curved, satin	1
	Medicine cup, 2 oz.	1
	Medicine dripper, glass	1
	Needles, 18G x 1½ in.	2
	Needles, 20G x 1½ in.	2
	Needles, 25G x 5⁄8 in.	2
	Scalpel, #10, stainless steel with plastic handle	1
	Scalpel, #11, stainless steel with plastic handle	1
	Suction handle, Frazier, 8 Fr.	1
	Suction handle, Frazier, 10 Fr., vented	1
	Syringe, luer lock, 6 mL	1
	Syringes, luer lock, 12 mL	2
	Towels, 13 x 19 in., poly lined	4
	Towel, blue, scrim	1

Tracheostomy Care Tray

Case Quantity: 20

Cat. No.	Contents	Quantity
11-1101A	Cotton tip applicator, 6 in., plastic	2
	Exam gloves, large, pair	1
	Gauze, 4x4 in.	4
	Hydrogen peroxide, 3%, foil pouches, 1 oz.	2
	Instrument, forcep, plastic	1
	Pipe cleaners	3
	Sponge, T-drain, 4X4 in., 6-ply, 2/pk	1
	Towel, 17x18, poly-backed	1
	Trach brush, large	1
	Twill, 36 in.	1
	Two-compartment tray	1

All products listed on this page are not made with natural rubber latex.

Minor Procedure Trays

Skin Prep Trays – Dry Prep

Dry Prep Trays	Sterile				Non-sterile (in-kit only)		
	11-7000	11-7002	11-7003	11-7010	A11-9002NS	A11-9003NS	A11-9010NS
Kit number:	11-7000	11-7002	11-7003	11-7010	A11-9002NS	A11-9003NS	A11-9010NS
Case quantity	20/case	20/case	20/case	20/case			
GLOVES							
Exam gloves, large walleled, pair	1	1	1	1	1	1	1
MISCELLANEOUS							
Cotton tip applicator, 6 in.	2	2	2	6	2	2	6
Emesis basin, 700cc				1			1
Gauze, 4 x 4 in., 16-ply		8			8		
Gauze, non-woven, 4 x 4 in., 4-ply				10			10
Instrument, forceps, plastic		1	1	1	1	1	1
Medicine cup, 2 oz.				3			3
Syringe, bulb, 2 oz.				1			1
PACKAGING							
CSR wrap, 28 x 28 in.	1	1	1	1	1	1	1
Foam tray	1						
Three-compartment tray			1		1	1	
Four-compartment tray		1					
SPONGES							
Foam small wing sponge	4	3	6			6	
Foam sponge stick		2	3		2	3	
TOWELS							
Towel, blue, scrim	2		2	2		2	2
Towel, white, poly lined, 17 x 18 in.	2	2	2	2	2	2	2

All dry prep trays include:

- 2 cotton tip applicators
- 1 pair of exam gloves, medium, powder-free
- 2 towels, white, absorbent

All products listed on this page are not made with natural rubber latex.

Minor Procedure Trays

Skin Prep Trays – Dry Prep



Dry Prep Tray - Small Wing Sponges

Case Quantity: 20

Cat. No.	Contents	Quantity
11-7000	Cotton tip applicator, 6 in.	2
	CSR wrap, 28 x 28 in.	1
	Exam gloves, large walleded, pair	1
	Foam small wing sponge	4
	Foam tray	1
	Towel, blue, scrim	2
	Towel, white, poly lined, 17 x 18 in.	2



Dry Prep Tray - Basic

Case Quantity: 20

Cat. No.	Contents	Quantity
11-7003	Cotton tip applicator, 6 in.	2
	CSR wrap, 28 x 28 in.	1
	Exam gloves, large walleded, pair	1
	Foam small wing sponge	6
	Foam sponge stick	3
	Instrument, forceps, plastic	1
	Three-compartment tray	1
	Towel, blue, scrim	2
	Towel, white, poly lined, 17 x 18 in.	2



Dry Prep Tray - Gauze

Case Quantity: 20

Cat. No.	Contents	Quantity
11-7002	Cotton tip applicator, 6 in.	2
	CSR wrap, 28 x 28 in.	1
	Exam gloves, large walleded, pair	1
	Foam small wing sponge	3
	Foam sponge stick	2
	Four-compartment tray	1
	Gauze, 4 x 4 in. 16-ply	8
	Instrument, forceps, plastic	1
	Towel, white, poly lined, 17 x 18 in.	2



Dry Prep Tray - Eye Prep

Case Quantity: 20

Cat. No.	Contents	Quantity
11-7010	Cotton tip applicator, 6 in.	6
	CSR wrap, 28 x 28 in.	1
	Emesis basin, 700cc	1
	Exam gloves, large walleded, pair	1
	Gauze, non-woven, 4 x 4 in., 4-ply	10
	Instrument, forceps, plastic	1
	Medicine cup, 2 oz.	3
	Syringe, bulb, 2oz.	1
	Towel, blue, scrim	2
	Towel, white, poly lined, 17 x 18 in.	2

All products listed on this page are not made with natural rubber latex.

Minor Procedure Trays

Skin Prep Trays – Dry Prep



Dry Prep Tray - Gauze (Non-sterile equivalent of 11-7002, available in-kit only)

Case Quantity: 20

Cat. No.	Contents	Quantity
A11-9002NS	Cotton tip applicator, 6 in.	2
	CSR wrap, 28 x 28 in.	1
	Exam gloves, large walleded, pair	1
	Foam sponge stick	2
	Three-compartment tray	1
	Gauze, 4 x 4 in. 16-ply	8
	Instrument, forceps, plastic	1
	Towel, white, poly lined, 17 x 22 in.	2



Dry Prep Tray - Eye Prep (Non-sterile equivalent of 11-7010, available in-kit only)

Case Quantity: 20

Cat. No.	Contents	Quantity
A11-9010NS	Cotton tip applicator, 6 in.	6
	CSR wrap, 28x28in	1
	Emesis basin, 700cc	1
	Exam gloves, large walleded, pair	1
	Gauze, non-woven, 4 x 4in 4-ply	10
	Instrument, forceps, plastic	1
	Medicine cup, 2 oz.	3
	Syringe, bulb, 2oz	1
	Towel, blue, scrim	2
	Towel, white, poly lined, 17x18in	2

Skin Prep Trays



Dry Prep Tray - Basic (Non-sterile equivalent of 11-7003, available in-kit only)

Case Quantity: 20

Cat. No.	Contents	Quantity
A11-9003NS	Cotton tip applicator, 6 in.	2
	CSR wrap, 28 x 28 in.	1
	Exam gloves, large walleded, pair	1
	Foam small wing sponge	6
	Foam sponge stick	3
	Instrument, forceps, plastic	1
	Three-compartment tray	1
	Towel, blue, scrim	2
	Towel, white, poly lined, 17 x 18 in.	2

All products listed on this page are not made with natural rubber latex.

Minor Procedure Trays

Skin Prep Trays – Wet Prep

Wet Prep Trays	Sterile							Non-sterile (in-kit only)				
	11-7005	11-7006	11-7007	11-7008	11-7009	11-7011	11-7012	A11-9004NS	A11-9006NS	A11-9007NS	A11-9011NS	A11-9012NS
Kit number:	20/case	20/case	20/case	20/case	20/case	20/case	20/case					
Case quantity	20/case	20/case	20/case	20/case	20/case	20/case	20/case					
GLOVES												
Exam gloves, large walled, pair	1	1	1	1	1	1	1	1	1	1	1	1
MISCELLANEOUS												
Cotton tip applicator, 6 in.	2	2	2	2	2	2	2	2	2	2	2	2
PACKAGING												
CSR wrap, 28 x 28 in.	1	1	1	1	1	1	1	1	1	1	1	1
Two-compartment tray					1		1					1
Three-compartment tray			1	1					1	1		
SOLUTIONS												
PVP-I gel, 4 oz. bottle							1				1	
PVP-I paint, 2 oz. screw cap bottle					1							
PVP-I paint, 3 oz. screw cap bottle			1	1					1	1		
PVP-I paint, sponge sticks, 2/pk	1	1						1				
CHG scrub, 4 oz. flip cap bottle							1					1
PVP-I scrub, 4 oz. screw cap bottle			1	1	1				1	1		
PVP-I scrub, large wing sponges, 2/pk	1	1						1				
PVP-I scrub, sponge sticks, 2/pk	1											
SPONGES												
Foam small wing sponge			6	6	3	4	6		6	6	4	6
Foam sponge stick			3	3	2				3	1		
Foam sponge stick, vaginal	1		3							3		
TOWELS												
Towel, blue, scrim	2	2	2	2	2	2	2	2	2	2	2	2
Towel, white, poly lined, 17 x 18 in.		2	1	2	2		2	2	2	1		2
Towel, white, poly lined, 17 x 22 in.	1									1		

Please contact your Cardinal Health Sales Representative or email PresourceSolutions@cardinalhealth.com for more information

All products listed on this page are not made with natural rubber latex.

Minor Procedure Trays

Skin Prep Trays – Wet Prep



Wet Prep Tray - Vaginal/Abdominal

Case Quantity: 20

Cat. No.	Contents	Quantity
11-7005	Cotton tip applicator, 6 in.	2
	CSR wrap, 28 x 28 in.	1
	Exam gloves, large walleded, pair	1
	Foam sponge stick, vaginal	1
	PVP-I paint, sponge sticks, 2/pk	1
	PVP-I scrub, large wing sponges, 2/pk	1
	PVP-I scrub, sponge sticks, 2/pk	1
	Towel, blue, scrim	2
	Towel, white, poly lined, 17 x 22 in.	1



Wet Prep Tray - Vaginal

Case Quantity: 20

Cat. No.	Contents	Quantity
11-7007	Cotton tip applicator, 6 in.	2
	CSR wrap, 28 x 28 in.	1
	Exam gloves, large walleded, pair	1
	Foam small wing sponge	6
	Foam sponge stick	3
	Foam sponge stick, vaginal	3
	PVP-I paint, 3 oz. screw cap bottle	1
	PVP-I scrub, 4 oz. screw cap bottle	1
	Three-compartment tray	1
	Towel, blue, scrim	2
	Towel, white, poly lined, 17 x 18 in.	1

Skin Prep Trays



Wet Prep Tray - Impregnated Sponges

Case Quantity: 20

Cat. No.	Contents	Quantity
11-7006	Cotton tip applicator, 6 in.	2
	CSR wrap, 28 x 28 in.	1
	Exam gloves, large walleded, pair	1
	PVP-I paint, sponge sticks, 2/pk	1
	PVP-I scrub, large wing sponges, 2/pk	1
	Towel, blue, scrim	2
	Towel, white, poly lined, 17x18 in.	2



Wet Prep Tray - PVP Bottles

Case Quantity: 20

Cat. No.	Contents	Quantity
11-7008	Cotton tip applicator, 6 in.	2
	CSR wrap, 28 x 28 in.	1
	Exam gloves, large walleded, pair	1
	Foam small wing sponge	6
	Foam sponge stick	3
	PVP-I paint, 3 oz. screw cap bottle	1
	PVP-I scrub, 4 oz. screw cap bottle	1
	Three-compartment tray	1
	Towel, blue, scrim	2
	Towel, white, poly lined, 17 x 18 in.	2

All products listed on this page are not made with natural rubber latex.

Minor Procedure Trays

Skin Prep Trays – Wet Prep



Wet Prep Tray - Basic

Case Quantity: 20

Cat. No.	Contents	Quantity
11-7009	Cotton tip applicator, 6 in.	2
	CSR wrap, 28 x 28 in.	1
	Exam gloves, large walled, pair	1
	Foam small wing sponge	3
	Foam sponge stick	2
	PVP-I paint, 2 oz. screw cap bottle	1
	PVP-I scrub, 2 oz. screw cap bottle	1
	Towel, blue, scrim	2
	Towel, white, poly lined, 17 x 18 in.	2
	Two-compartment tray	1

Wet Prep Tray - CHG Bottle

Case Quantity: 20

Cat. No.	Contents	Quantity
11-7012	CHG scrub, 4 oz. flip cap bottle	1
	Cotton tip applicator, 6 in.	2
	CSR wrap, 28 x 28 in.	1
	Exam gloves, large walled, pair	1
	Foam small wing sponge	6
	Towel, blue, scrim	2
	Towel, white, poly lined, 17 x 18 in.	2
	Two-compartment tray	1



Wet Prep Tray - PVP Gel

Case Quantity: 20

Cat. No.	Contents	Quantity
11-7011	Cotton tip applicator, 6 in.	2
	CSR wrap, 28 x 28 in.	1
	Exam gloves, large walled, pair	1
	Foam small wing sponge	4
	PVP-I gel, 4 oz. bottle	1
	Towel, blue, scrim	2

All products listed on this page are not made with natural rubber latex.

Minor Procedure Trays

Skin Prep Trays – Wet Prep



Wet Prep Tray - Impregnated Sponges (Non-sterile equivalent of 11-7006, available in-kit only)

Case Quantity: 20

Cat. No.	Contents	Quantity
A11-9004NS	Cotton tip applicator, 6 in.	2
	CSR wrap, 28 x 28 in.	1
	Exam gloves, large walled, pair	1
	PVP-I paint, sponge sticks, 2/pk	1
	PVP-I scrub, large wing sponges, 2/pk	1
	Towel, blue, scrim	2
	Towel, white, poly lined, 17 x 18 in.	2



Wet Prep Tray - Vaginal (Non-sterile equivalent of 11-7007, available in-kit only)

Case Quantity: 20

Cat. No.	Contents	Quantity
A11-9007NS	Cotton tip applicator, 6 in.	2
	CSR wrap, 28 x 28 in.	1
	Exam gloves, large walled, pair	1
	Foam small wing sponge	6
	Foam sponge stick	1
	Foam sponge stick, vaginal	3
	PVP-I paint, 3 oz. screw cap bottle	1
	PVP-I scrub, 4 oz. screw cap bottle	1
	Three-compartment tray	1
	Towel, blue, scrim	2
	Towel, white, poly lined, 17 x 22 in.	2



Wet Prep Tray - PVP Bottles (Non-sterile equivalent of 11-7008, available in-kit only)

Case Quantity: 20

Cat. No.	Contents	Quantity
A11-9006NS	Cotton tip applicator, 6 in.	2
	CSR wrap, 28 x 28 in.	1
	Exam gloves, large walled, pair	1
	Foam small wing sponge	6
	Foam sponge stick	3
	PVP-I paint, 3 oz. screw cap bottle	1
	PVP-I scrub, 2 oz. screw cap bottle	1
	Three-compartment tray	1
	Towel, blue, scrim	2
	Towel, white, poly lined, 17 x 18 in.	2

All products listed on this page are not made with natural rubber latex.

Minor Procedure Trays

Skin Prep Trays – Wet Prep



Wet Prep Tray - PVP Gel (Non-sterile equivalent of 11-7011, available in-kit only)

Case Quantity: 20

Cat. No.	Contents	Quantity
A11-9011NS	Cotton tip applicator, 6 in.	2
	CSR wrap, 28 x 28 in.	1
	Exam gloves, large walled, pair	1
	Foam small wing sponge	4
	PVP-I gel, 4 oz. bottle	1
	Towel, blue, scrim	2

Wet Prep Tray - CHG Bottle (Non-sterile equivalent of 11-7012, available in-kit only)

Case Quantity: 20

Cat. No.	Contents	Quantity
A11-9012NS	CHG scrub, 4 oz. flip cap bottle	1
	Cotton tip applicator, 6 in.	2
	CSR wrap, 28 x 28 in.	1
	Exam gloves, large walled, pair	1
	Foam small wing sponge	6
	Towel, blue, scrim	2
	Towel, white, poly lined, 17 x 18 in.	2
	Two-compartment tray	1



All products listed on this page are not made with natural rubber latex.

Minor Procedure Trays

Suture Removal Trays

Suture Removal Tray

Case Quantity: 50

Cat. No.	Contents	Quantity
06-6000	Alcohol prep pad	1
	Gauze, 3 x 3 in., 12-ply	1
	Instrument, forceps, Adson, 4¾ in., serrated	1
	Instrument, scissors, Iris, 4½ in. straight, tip protector	1
	PVP prep pad	1

Staple Removal Tray

Case Quantity: 50

Cat. No.	Contents	Quantity
06-6700	Alcohol prep pad	1
	Gauze, 3 x 3 in., 12-ply	1
	PVP prep pad	1
	Staple remover, 4 in.	1

Suture Removal Tray

Case Quantity: 50

Cat. No.	Contents	Quantity
06-6300	Gauze 3 x 3 in., 12-ply	1
	Instrument, forceps, plastic	1
	Instrument, scissors, Littauer, 4½ in., wire	1

Suture Removal Tray

Case Quantity: 50

Cat. No.	Contents	Quantity
06-7100	Gauze, 3 x 3 in., 12-ply	1
	Instrument, forceps, Adson, 4¾ in., serrated	1
	Instrument, scissors, Iris, 4½ in. straight, tip protector	1

Suture Removal Tray

Case Quantity: 50

Cat. No.	Contents	Quantity
06-6400	Alcohol prep pad	1
	Gauze, 3 x 3 in., 12-ply	1
	Instrument, forceps, Adson, 4¾ in., serrated	1
	Instrument, scissors, Iris, 4½ in. curved, tip protector	1
	PVP prep pad	1

Suture Removal Tray

Case Quantity: 50

Cat. No.	Contents	Quantity
06-7200	Gauze, 3 x 3 in., 12-ply	1
	Instrument, forceps, Adson, 4¾ in., serrated	1
	Instrument, scissors, Littauer, 4½ in., stitch, straight	1

Suture Removal Tray

Case Quantity: 50

Cat. No.	Contents	Quantity
06-6500	Alcohol prep pad	1
	Gauze, 3 x 3 in., 12-ply	1
	Instrument, forceps, Adson, 4¾ in., serrated	1
	Instrument, scissors, Littauer, 4½ in., stitch, straight	1
	PVP prep pad	1

Suture Removal Tray

Case Quantity: 50

Cat. No.	Contents	Quantity
24000-005	Gauze, 3 x 3 in., 12-ply	1
	Instrument, forceps, insert, 5 in., wire	1
	Instrument, scissors, Littauer, 4½ in., wire	1

All products listed on this page are not made with natural rubber latex.

Minor Procedure Trays

Suture Removal Trays

Suture Removal Tray

Case Quantity: 50

Cat. No.	Contents	Quantity
24000-006	Gauze, 3 x 3 in., 12-ply	1
	Instrument, forceps, thumb, 4 to 5 in., wire	1
	Instrument, scissors, Littauer, 4½ in., wire	1

Suture Removal Tray

Case Quantity: 50

Cat. No.	Contents	Quantity
25000-050	Alcohol prep pad	1
	Gauze, 3 x 3 in., 12-ply	1
	Instrument, forceps, thumb, 4 to 5 in., wire	1
	Instrument, scissors, Littauer, 4½ in., stitch, straight	1
	PVP prep pad	1

Suture Removal Tray

Case Quantity: 50

Cat. No.	Contents	Quantity
24000-090	Alcohol prep pad	1
	Gauze, 3 x 3 in., 12-ply	1
	Instrument, forceps, insert, 5 in., wire	1
	Instrument, scissors, Littauer, facial wire	1
	PVP prep pad	1

Suture Removal Tray

Case Quantity: 50

Cat. No.	Contents	Quantity
BN06-8100	Instrument, scissors, operating, 5½ in., straight, sharp/sharp	1
	Instrument, forceps, thumb, 5½ in., serrated	1

Suture Removal Tray

Case Quantity: 50

Cat. No.	Contents	Quantity
25000-006	Alcohol prep pad	1
	Gauze, 3 x 3 in., 12-ply	1
	Instrument, forceps, thumb, 4 to 5 in., wire	1
	Instrument, scissors, Iris, 4½ in., curved, tip protector	1
	PVP prep pad	1

Suture Removal Tray

Case Quantity: 50

Cat. No.	Contents	Quantity
SR217	Instrument, forceps, Adson, 4¾ in., serrated	1
	Instrument, scissors, Iris, 4½ in., straight, tip protector	1

All products listed on this page are not made with natural rubber latex.

Minor Procedure Trays

Suture Removal Trays

Suture Removal Tray General Purpose

Case Quantity: 20

Cat. No.	Contents	Quantity
07-1000	Alcohol prep pad	1
	Cotton tip applicator, 3 in., plastic	2
	Gauze, 3 x 3 in., 12-ply	2
	Instrument, forceps, Adson tissue, 4¾ in., serrated jaws	1
	Instrument, forceps, halsted Mosquito, straight, 4½ in.	1
	Instrument, scissors, Iris, 4½ in., straight with tip protector	1
	Instrument tip protector	2
	Safety pin, 1½ in.	1
	Swabstick, PVP-I, single	1

Suture Removal Tray with Littauer Scissors, Forceps

Case Quantity: 50

Cat. No.	Contents	Quantity
24000-080	Alcohol prep pad	1
	Gauze, 3 x 3 in., 12-ply	1
	Instrument, forceps, wire, 4½ in.	1
	Instrument, scissors, Littauer, facial wire, 4 in.	1
	PVP-I prep pad	1

Suture Removal Tray with Iris Scissors, Adson Forceps

Case Quantity: 50

Cat. No.	Contents	Quantity
06-7000	Gauze, 3 x 3 in., 12-ply	1
	Instrument, forceps, Adson tissue, 4¾ in., serrated jaws	1
	Instrument, forceps, Halstead Mosquito, 5 in., curved	1
	Instrument, scissors, Iris, curved, sharp/sharp, 4½ in.	1

Suture Removal Tray with S/B Scissors, Kelly Forceps

Case Quantity: 50

Cat. No.	Contents	Quantity
NI06-6900	Gauze, 3 x 3 in., 12-ply	1
	Instrument, forceps, thumb dressing, serrated, 5½ in.	1
	Instrument, scissors, operating, 5½ in., straight, sharp/blunt	1
	Kelly forceps, straight, 5½ in.	1

Suture Removal Tray with Littauer Scissors, Forceps

Case Quantity: 50

Cat. No.	Contents	Quantity
06-7500	Gauze, 3 x 3 in., 12-ply	1
	Instrument, scissors, Littauer, wire, 4½ in.	1
	Instrument, wire forceps, 4-5 in.	1

Staple Removal Tray

Case Quantity: 20

Cat. No.	Contents	Quantity
06-7800	Gauze, 3 x 3 in., 12-ply	1
	Instrument, staple remover, 4 in.	1

All products listed on this page are not made with natural rubber latex.

Electrosurgical Supplies, Equipment Covers

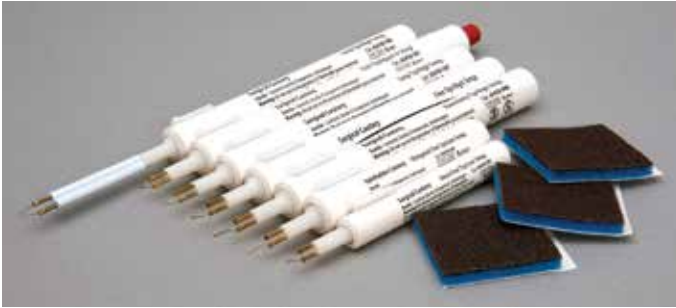

Cat. No.	Description	Quantity
Electrosurgical cautery tip cleaner		
300-2SS	Cautery cleaner pad, 1 7/8 x 1 7/8 in., foam backed, x-ray detectable	50/bx, 4 bx/cs
Cautery pencils		
65410-025	Cautery low temp, elongated fine tip	10/bx
65410-010	Cautery low temp, fine tip	10/bx
65410-290	Cautery low temp, micro fine tip	10/bx
65410-191	Cautery high temp, adjustable fine tip	10/bx
65410-040	Cautery high temp, elongated tip	10/bx
65410-185	Cautery high temp, extended 2 in. shaft	10/bx
65410-181	Cautery high temp, fine tip	10/bx
65410-183	Cautery high temp, loop tip	10/bx
65410-180	Cautery high temp, micro fine tip	10/bx

Video Camera and Laser Drapes

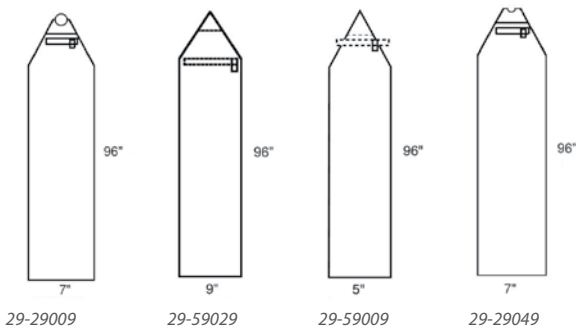

Cat. No.	Description	Quantity
29-29009	Closed system video camera drape, 7 x 96 in., 5/8 in. lens diameter	25/bx, 1 bx/cs
29-59029	Laser arm drape, 9 x 96 in., telescopic fold with cuff and adhesive closure strip	25/bx, 1 bx/cs
29-59009	Video camera drape, 5 x 96 in., telescopic fold with cuff and adhesive closure strip	25/bx, 1 bx/cs
29-29049	Video camera drape, 7 x 96 in., elastic tip, telescopic fold with cuff and adhesive closure strip	25/bx, 1 bx/cs

Microscope Drapes for Zeiss MD Microscopes

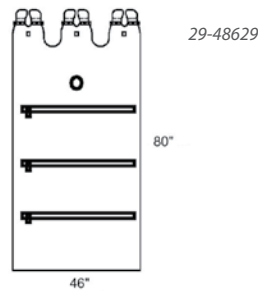

Cat. No.	Description	Quantity
29-48629	Microscope drape, 46 x 80 in., with stereo observation tubes, poly drawstraps and Ocu-Lok closures	5/bx, 2 bx/cs
29-48389	Microscope drape, 46 x 120 in., with stereo observation tubes, poly drawstraps and Ocu-Lok closures	5/bx, 2 bx/cs

Microscope Drapes for OPMI Microscopes

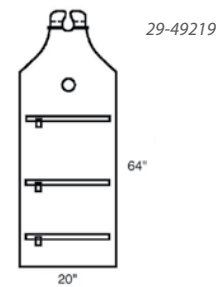

Cat. No.	Description	Quantity
29-49219	Microscope drape, 20 x 64 in., with regular length arm cover, poly drawstraps and Ocu-Lok closures	20/bx, 1 bx/cs
29-49319	Microscope drape, 40 x 64 in., with monocular observation tubes, poly drawstraps and Ocu-Lok closures	10/bx, 2 bx/cs
29-49459	Microscope drape, 40 1/2 x 64 in., with monocular or stereo observation tubes with external illuminators, poly drawstraps and Ocu-Lok closures	10/bx, 2 bx/cs
29-29629	Microscope drape, 41 x 80 in., with monocular or stereo observation tubes, poly drawstraps and Ocu-Lok closures	5/bx, 2 bx/cs
29-29389	Microscope drape, 41 x 120 in., with monocular or stereo observation tubes, poly drawstraps and Ocu-Lok closures	5/bx, 2 bx/cs

OR Accessories

Equipment Covers

Microscope Drapes for Leica® Microscopes

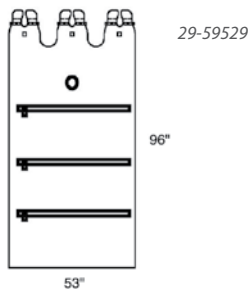

Cat. No.	Description	Quantity
29-59529	Microscope drape, 53 x 96 in., with monocular or stereo observation tubes, poly drawstraps and Ocu-Lok closures	5/bx, 2 bx/cs

Microscope/Laser Drape

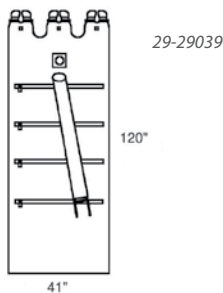

Cat. No.	Description	Quantity
29-29039	Microscope/laser drape, 41 x 120 in., 1-piece design with attached extra-long laser, poly drawstraps and Ocu-Lok closures	5/bx, 2 bx/cs

X-ray Cassette Drapes

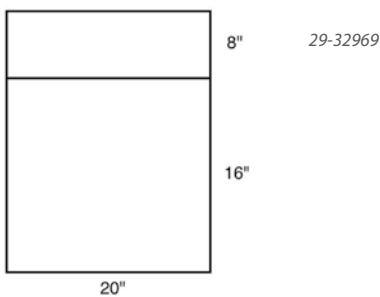

Cat. No.	Description	Quantity
29-32969	X-ray cassette drape, 20 x 24 in.	50/cs
29-25329	X-ray cassette drape, 20 x 24 in., with poly release liner	25/bx, 2 bx/cs
8720	X-ray cassette drape, 21 x 36 in.	30/cs
29-49559	X-ray cassette drape, 21 x 40 in., with double cuff and seamless bottom design	50/bx, 1 bx/cs

Ultrasound Probe Drape

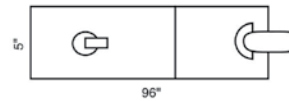

29-37879

Cat. No.	Description	Quantity
29-37879	Ultrasound probe drape, 5 x 96 in., with elasticized material and 1-piece design for rounded/cylindrical probe heads	20/bx, 1 bx/cs

Banded Bags and C-Arm Drapes

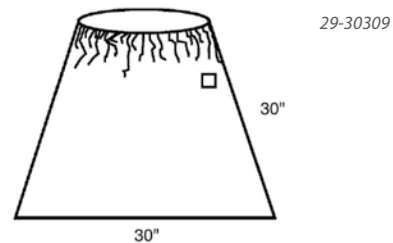

Cat. No.	Description	Quantity
29-30309	Banded bag, 30 x 30 in., with elastic opening	25/cs
29-36209	Banded bag, 36 x 20 in., with elastic opening	25/cs

Fluoroscope Banded Bag

Cat. No.	Description	Quantity
29-63629	Fluoroscope banded bag, 36 x 20 in., with elastic opening	25/cs

Universal Fluoroscope Banded Bag

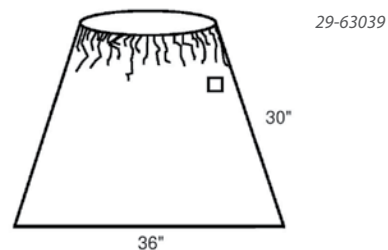

Cat. No.	Description	Quantity
29-63039	C-arm fluoroscope drape, 30 x 36 in., universal size with elastic opening	25/cs

Mini C-Arm Drape

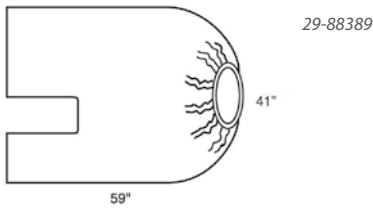

Cat. No.	Description	Quantity
29-88389	Mini c-arm drape, 41 x 59 in., 1-piece c-arm design with poly gathering strips	40/cs

Foot Control Drape

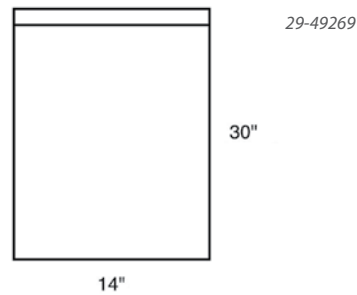

Cat. No.	Description	Quantity
29-49269	Foot control panel drape, 14 x 30 in., non-sterile, with adhesive closure strip	50/cs

Universal C-Arm/Mobile X-ray Drape

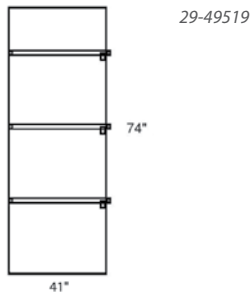

Cat. No.	Description	Quantity
29-49519	C-arm drape, 41 x 74 in., universal size, with poly drawstraps	10/bx, 2 bx/cs

Ancillary Drapes - Vertical Patient Isolation Drape

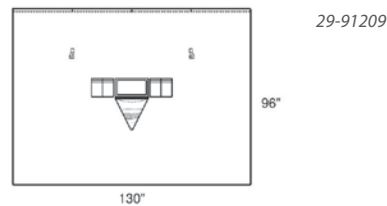

Cat. No.	Description	Quantity
29-91209	Vertical patient isolation drape, 96 x 130 in. with 8 x 16 in. microban antimicrobial adhesive area, fluid-collection pouch with drainage port and screen, instrument pockets, cord holders and insertion sleeves for attachment to horizontal rod	10/cs

Isolation Bag

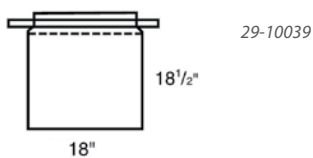

Cat. No.	Description	Quantity
29-10039	Isolation bag, 18 x 18½ in., with drawstring closure	10/bx, 1 bx/cs

OR Accessories

Esmark Bandages, Insufflation Tubing, Lap Sponges



Esmark bandages

- Available in 3, 4 and 6 in. widths
- 9 or 12 ft. long

Cat. No.	Description	Quantity
836-3409	4 in. x 3 yd.	36/cs
836-3412	4 in. x 4 yd.	36/cs
836-3609	6 in. x 3 yd.	36/cs
836-3612	6 in. x 4 yd.	36/cs



Insufflation Tubing

Cat. No.	Description	Quantity
C-2000-ST	10 ft. with hi-flow filter, rotating luer lock fitting	25 pk/cs
C-2003-ST	10 ft. with hi-flow filter, push-on fitting	25 pk/cs
C-2005-ST	10 ft. with hi-flow filter, quick-connect fitting	25 pk/cs
C-2025-ST	10 ft. with quick-connect fitting, pressure sense line	25 pk/cs
C-2012-ST	12 ft. with hi-flow filter, rotating luer lock fitting	25 pk/cs



Lap sponges

Our 100% cotton disposable lap sponges have a 4 in. x-ray-detectable element sewn inside. Sponges are available in a wide variety of styles and sizes—choose from sterile or non-sterile, prewashed or unwashed sponges in a tub, soft pack or bulk pack. Supplied in packages of five.

Cat. No.	Description	Quantity
Nonsterile, prewashed sponges in bulk pack		
23250-211	12 x 12 in., prewashed, nonsterile	5/pk, 40 pk/cs
23250-200	18 x 18 in., prewashed, nonsterile	5/pk, 40 pk/cs
Nonsterile, unwashed sponges in bulk pack		
23250-204	18 x 18 in., unwashed, nonsterile	5/pk, 40 pk/cs
Sterile, prewashed sponges in soft pack		
23250-407	4 x 18 in., prewashed soft pack, sterile	5/pk, 40 pk/cs
23250-419	8 x 36 in., prewashed soft pack, sterile	5/pk, 40 pk/cs
23250-411	12 x 12 in., prewashed soft pack, sterile	5/pk, 40 pk/cs
23250-400A	18 x 18 in., prewashed soft pack, sterile	5/pk, 40 pk/cs
23250-402	18 x 18 in., plastic rings, prewashed soft pack, sterile	5/pk, 40 pk/cs
23250-403	18 x 18 in., without loops, prewashed soft pack, sterile	5/pk, 40 pk/cs
Sterile, unwashed sponges in soft pack		
23250-405	4 x 18 in., unwashed soft pack, sterile	5/pk, 40 pk/cs
23250-409	12 x 12 in., unwashed soft pack, sterile	5/pk, 40 pk/cs
23250-404	18 x 18 in., unwashed soft pack, sterile	5/pk, 40 pk/cs

All products listed on this page are not made with natural rubber latex.

Light Handle Covers, Medication Labels



Rigid light handle cover

Light handle cover

Flexible light handle cover

Light Handle Covers

Two light handle cover options are available for convenience—a rigid light handle cover and a flexible light handle cover.

- Easy to use and disposable to help eliminate costly reprocessing
- Adapters are available for all popular lights

Cat. No.	Description	Quantity
Flexible handle covers		
5128-FG	Light handle cover, flexible, green	1/pk, 32 pk/bx, 4 bx/cs
5160-2FG	Light handle cover, flexible, green	2/pk, 20 pk/bx, 4 bx/cs
5240-3FG	Light handle cover, flexible, green	3/pk, 20 pk/bx
Rigid handle covers		
524-RG	Light handle, rigid, green	1/pk, 24 pk/cs
548-2RG	Light handle, rigid, green	2/pk, 24 pk/cs
Rigid handle covers – made with 25-30% pre-consumer recycled material		
ECH-01	Light handle, rigid	1/pk, 24 pk/cs
ECH-02	Light handle, rigid	2/pk, 24 pk/cs



Medication Labels

We offer medication labels that provide solutions for different healthcare facilities to assist with a variety of customer needs. The medication labels help healthcare providers comply with the JCAHO National Patient Safety Goals.



- Universal labels for syringes, medication cups, bowls and procedural basins
- Flexible enough to choose specific labels for your department
- Waterproof so safety is not compromised

Cat. No.	Description	Quantity
SPP99MLCLA	Standard cath lab label sheet	50/cs
SPP99IDCLA	Standard cath lab label sheet with initials and date	50/cs
SPP99MLCVA	Standard CV operating room label sheet	50/cs
SPP99IDENA	Standard ENT label sheet with initials and date	50/cs
SPP99MLEPA	Standard EP label sheet	50/cs
SPP99MLGNA	Standard (generic) label sheet	50/cs
SPP99IDGNA	Standard (generic) label sheet with initials and date	50/cs
SPP99MLORA	Standard operating room label sheet	50/cs
SPP99IDORA	Standard operating room label sheet with initials and date	50/cs
SPP99MLOPA	Standard ophthalmic label sheet	50/cs
SPP99IDOTA	Standard orthopedic label sheet with initials and date	50/cs

Each label set comes with label sheets and one fine tip permanent marker.

All products listed on this page are not made with natural rubber latex.

OR Accessories

Miscellaneous

Anti-fog solution with foam pad

Adhesive-backed, radiopaque sponge delivers solution where it's needed.

- Packaged in a convenient, single-procedure size.

Our anti-fog solution can be applied to endoscopic and surgical camera lenses to inhibit condensation and clouding. The solution is provided in an easy-to-squeeze, 6-gram bottle and includes a radiopaque sponge with an adhesive backing that can be securely affixed to a sponge stick, drape or anywhere convenient within the sterile field. For single patient/procedure use only.



Cat. No.	Description	Quantity
CF-1001	Anti-fog solution with foam pad	20/cs

Sponge counter bag

Our sponge counter bags are an economical alternative for the convenient disposal of used sponges. Each bag holds up to five lap sponges or ten 4 x 4 in. gauze. Transparent polyethylene pockets and a bright blue backing provide clear visibility of sponges. Provided non-sterile.

Cat. No.	Description	Quantity
R100	Rack sponge counter bag, non-sterile	1/ea
75-990-000	Sponge counter bag, blue back, non-sterile	250/cs

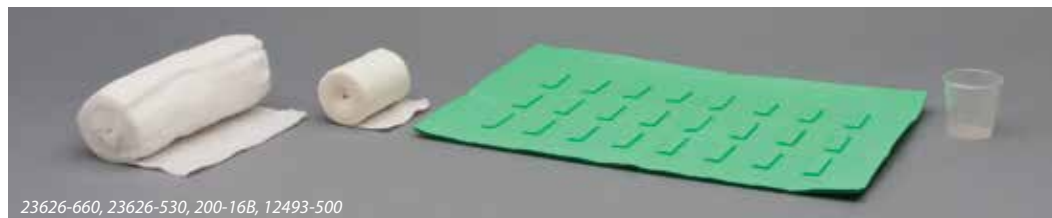

23626-660, 23626-530, 200-16B, 12493-500



19510-035

Cat. No.	Description	Quantity
23626-530	Cast padding, 3 in., sterile	36 pk/cs
23626-540	Cast padding, 4 in., sterile	36 pk/cs
23626-560	Cast padding, 6 in., sterile	36 pk/cs
23626-640	Cast padding, 4 in., spec, sterile	36 pk/cs
23626-660	Cast padding, 6 in., spec, sterile	36 pk/cs
159055A	Cord holder, adhesive strap with Velcro®	2/pk, 200 pk/cs
C15000-300	Cotton balls, large, 2¼ sq. in.	5/pk, 100 pk/cs
C15000-310	Cotton balls, large, 2¼ sq. in.	10/pk, 100 pk/cs
14-1000	Cotton tip applicators, 6 in., wood shaft	10/pk, 100 pk/cs
100-10B	Disposable magnetic instrument pad, small, 3 x 4 in., sterile	50/bx, 4 bx/cs
200-16B	Disposable magnetic instrument pad, medium, 10 x 16 in., sterile	48/cs
200-20B	Disposable magnetic instrument pad, large, 16 x 20 in., sterile	24/cs
12493-500	Medicine cup, 2 oz., clear, sterile	100 pk/cs
C28000-020	Rubber bands	2/pk, 100 pk/cs
C18700-020	Safety pin, sterile	2/pk, 100 pk/cs
*19510-035	Tomac lukens tube 8 cc, 3¼ in.	12/bx, 4 bx/cs
*19510-065	Tomac lukens tube 20 cc, 6¼ in.	12/bx, 4 bx/cs
14-0057	Towel clamp, plastic, 2½ in.	4/pk, 50 pk/cs

*Products contain natural rubber latex. All the rest of the products listed on this page are not made with natural rubber latex.



Needle Counters

- Wide range of configurations and styles
- Optional safety version with box lock and blade disarmer available
- Components and construction not made with natural rubber latex

Cat. No.	Description	Quantity
Foam block needle counter		
NC404SST	10/20 count, double foam block	7/bx, 8 bx/cs
NC108SST	40/80 count, double foam block	6/bx, 8 bx/cs
3FF80SSA	40/80 count, double foam block	6/bx, 8 bx/cs
LB402SST	10/20 count, double foam block, with box lock	40/cs
LB101SST	20/40 count, double foam block, with box lock	40/cs
LB701SST	40/80 count, double foam block, with box lock	40/cs
Foam/magnetic needle counter		
3FM20SSA	10/20 count, foam block, magnet	7/bx, 8 bx/cs
3FM40SSA	20/40 count, foam block, magnet	6/bx, 8 bx/cs
3FM70SSA	40/70 count, foam block, magnet	6/bx, 8 bx/cs
LB401SST	10/20 count, foam block, magnet, with box lock and blade disarmer	40/cs
LB102SST	20/40 count, foam block, magnet, with box lock and blade disarmer	40/cs
LB702SST	40/70 count, foam block, magnet, with box lock and blade disarmer	40/cs
4FM100SBBL	60/100 count, foam block, magnet, with box lock and blade disarmer	40/cs
Magnetic needle counter		
3MM20SSA	10/20 count, double magnets	12/bx, 6 bx/cs
3MM30SSA	15/30 count, double magnets	12/bx, 6 bx/cs
3MM60SSA	30/60 count, double magnets	12/bx, 6 bx/cs
LB103SST	10/20 count, double magnets, with box lock and blade disarmer	40/cs
LB230SST	15/30 count, double magnets, with box lock and blade disarmer	40/cs
LB703SST	30/60 count, double magnets, with box lock and blade disarmer	40/cs

All products listed on this page are not made with natural rubber latex.

OR Accessories

OR Towels

Disposable OR Towels

Our single sterile disposable OR towels are offered in white, blue and green. Towels are wrapped in a poly CSR wrap and packaged in a peel pouch, except for towel **28100-999**, which is non-sterile and bulk packed.

Cat. No.	Description	Quantity
Non-sterile blue towel		
28100-999	17 x 24 in., blue, bulk, non-sterile	100 pk/cs
Sterile blue towels		
28700-001	17 x 24 in., blue, sterile	1/pk, 80 pk/cs
28700-002	17 x 24 in., blue, sterile	2/pk, 40 pk/cs
28700-004	17 x 24 in., blue, sterile	4/pk, 20 pk/cs
28700-006	17 x 24 in., blue, sterile	6/pk, 12 pk/cs
28700-008	17 x 24 in., blue, sterile	8/pk, 10 pk/cs
28700-010	17 x 24 in., blue, sterile	10/pk, 8 pk/cs
28700-012	17 x 24 in., blue, sterile	12/pk, 6 pk/cs
Sterile green towels		
28200-001	17 x 24 in., green, sterile	1/pk, 80 pk/cs
28200-002	17 x 24 in., green, sterile	2/pk, 40 pk/cs
28200-004	17 x 24 in., green, sterile	4/pk, 20 pk/cs
28200-006	17 x 24 in., green, sterile	6/pk, 12 pk/cs
Sterile white towels		
28300-002	17 x 24 in., white, sterile	2/pk, 40 pk/cs
28300-004	17 x 24 in., white, sterile	4/pk, 20 pk/cs
28300-006	17 x 24 in., white, sterile	6/pk, 12 pk/cs



X-ray detectable OR Towels

OR personnel can identify the x-ray detectable towel by the special tag sewn into each towel. White, blue and green towels are sterile and wrapped in a poly CSR wrap and packaged in a peel pouch.

Cat. No.	Description	Quantity
Sterile blue x-ray towels		
28700-002X	Blue, x-ray detectable, sterile	2/pk, 40 pk/cs
28700-004X	Blue, x-ray detectable, sterile	4/pk, 20 pk/cs
28700-006X	Blue, x-ray detectable, sterile	6/pk, 12 pk/cs
Sterile green x-ray towels		
28200-004X	Green, x-ray detectable, sterile	4/pk, 20 pk/cs
Sterile white x-ray towels		
28300-002X	White, x-ray detectable, sterile	2/pk, 40 pk/cs
28300-004X	White, x-ray detectable, sterile	4/pk, 20 pk/cs
28300-006X	White, x-ray detectable, sterile	6/pk, 12 pk/cs



Universal Low Lint Towels

Cat. No.	Description	Quantity
UB017026	Blue, bulk, non-sterile	240/cs
UG017026	Green, bulk, non-sterile	240/cs
SPP99UB2PK	Low lint towels, blue, sterile	2/pk, 70 pk/cs
SPP99UB4PK	Low lint towels, blue, sterile	4/pk, 70 pk/cs

All products listed on this page are not made with natural rubber latex.

Skin and Utility Markers, Vessel Loops, OR Plastics



270P, prep resistant marker, regular-tip, sterile



212MIL, dual-tip/multi-ink skin marker (with labels)



250SM, small skin marker



250GPR, skin marker regular-tip (with ruler)



250FPRL, skin marker, fine-tip (with ruler and labels)



212WPRA, skin marker, regular-tip, wide barrel (with ruler)

Skin and Utility Markers

Nontoxic, non-tattooing, gentian violet ink is surgical prep-resistant.

- Nonabrasive tip minimizes tissue trauma
- Fine, regular and multi-tip options

Cat. No.	Description	Quantity
Prep resistant markers		
270P-NS	Regular-tip, non-sterile	500/bx
270P	Regular-tip, sterile	50/bx
270PRL	Regular-tip, ruler and labels, sterile	50/bx
Non-sterile skin markers		
PP-100	Multi-tip, non-sterile	100/bx
250SMNS	Small, non-sterile	100/bx, 12 bx/cs
Skin markers		
212MIL	Dual-tip, multi-ink, labels	12/bx, 56 bx/cs
SPP99DT1AA	Dual-tip, multi-ink, 6 in. ruler	100/cs
SPP99DT2AA	Dual-tip, multi-ink, 6 in. ruler and labels	100/cs
250FPRL	Fine-tip, 6 in. ruler and labels	50/bx, 12 bx/cs
250GPR	Regular-tip, 6 in. ruler	50/bx, 12 bx/cs
250GPRL	Regular-tip, 6 in. ruler and labels	50/bx, 12 bx/cs
212WPRA	Regular-tip, 6 in. ruler, wide barrel	12/bx, 75 bx/cs
212PR	Skin marker, 6 in. ruler	12/bx, 75 bx/cs
250SM	Skin marker, small	50/bx, 12 bx/cs
250P	Taper-tip skin marker	50/bx, 12 bx/cs
250PR	Taper-tip, 6 in. ruler	50/bx, 12 bx/cs
250PRL	Taper-tip, 6 in. ruler and labels	50/bx, 12 bx/cs
Utility markers		
225UTFL	Fine- tip, labels, sterile	25/bx, 4 bx/cs
UT-50	Regular-tip, labels, wide barrel, non-sterile	50/cs
225UTL	Regular-tip, labels, wide barrel, sterile	25 pk/bx, 4 bx/cs

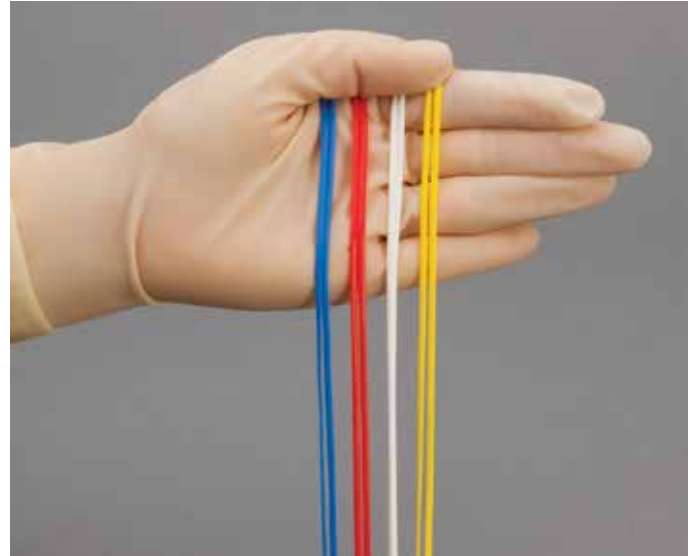

Vessel Loops

Cat. No.	Description	Quantity
Maxi vessel loops		
HT9945678A	Vessel loops, maxi, blue, 2/pk	200/cs
HT9945744A	Vessel loops, maxi, red, 2/pk	200/cs
HT9945686A	Vessel loops, maxi, white, 2/pk	200/cs
HT9945694A	Vessel loops, maxi, yellow, 2/pk	200/cs
Mini vessel loops		
HT9945702A	Vessel loops, mini, blue, 2/pk	200/cs
HT9945710A	Vessel loops, mini, red, 2/pk	100/cs
HT9945660A	Vessel loops, mini, white, 1/pk	200/cs
HT9945728A	Vessel loops, mini, yellow, 1/pk	200/cs

OR Plastics

Cat. No.	Description	Quantity
13752-623	7 quart basin, single wrapped	5/cs
13752-624	7 quart basin, double wrapped	5/cs
SSK3001	7 quart basin, single wrapped	6/cs
SSK3002	7 quart basin, double wrapped	6/cs
SSK9009A	Bowl, guidewire, 2500 cc with lid	20/cs
SSK9005A	Emesis basis, 700 mL	30/cs
SSK9012A	Medicine cup, 2 oz., with lids	2/pk, 100 pk/cs
SSK9004A	Pitcher, 1200 mL	30/cs
SSK9010A	Safety transfer tray	30/cs
SSK9001A	Sponge bowl, 16 oz.	33/cs
SSK9002A	Sponge bowl, 32 oz.	30/cs

All products listed on this page are not made with natural rubber latex.

OR Accessories

OR Setup and Basin Kits

Minor Setup

	SSK1001A	SSK1003	SSK1004	SSK9022A	SSK9023A
Kit Number					
Case Quantity	30	30	10	30	30
Bedside bag	1	1	1		
Cautery tip cleaner	1	1	1	1	1
CSR wrap, 18 x 18 in.					
CSR wrap, 20 x 20 in.					2
CSR wrap, 24 x 24 in.					
CSR wrap, 30 x 30 in.	1	1	1	1	
Gauze, 4 x 4 in., 16-ply, x-ray		10	10		
Lid for 2 oz. medicine cup		1	1		
Light handle covers, flexible	2	2		2	2
Light handle covers, rigid			2		
Medicine cup, 2 oz.		1	1		
Needle counter, 20-40 count, double magnets					
Needle counter, 20-40 count, foam block, magnet, blade disarmer	1	1	1		
Needle counter, 30-60 count, foam strip, magnet, blade disarmer				1	
Needle counter, 40-70 count, foam block, magnet					1
Needle counter, 40-100 count, foam block, double magnet					
Pitcher, 1,200 cc					
Skin marker, with ruler and 9 labels	1	1	1		
Specimen container, 4½ in., with screw lid		1	1		
Sponge bowl, 16 oz.					
Sponge bowl, 32 oz.		1	1		
Surgical blades, #15, carbon steel		2	2		



Major Setup

	SSK2001	SSK2002A	SSK2005	SSK9028A	SSK9031A	SSK9033A	SSK9036A	SSK9038A	SSK9039A	SSK9040A	SSK9043A
Kit Number											
Case Quantity	10	10	10	10	10	10	10	10	10	12	10
Bedside bag	1	1	1	1		1		1	1	1	1
Cautery pencil, push button, with blade and holster						1		1	1	1	1
Cautery pencil, rocker switch, with blade and holster		1	1								
Cautery tip cleaner	1	1	1	1	1		1				
CSR wrap, 30 x 30 in.	1	1	1	2	1	2	1	1			
CSR wrap, 36 x 36 in.									1	2	
CSR wrap, 45 x 45 in.											1
Gauze, 4 x 4 in., 16-ply, non x-ray											10
Gauze, 4 x 4 in., 16-ply, x-ray	10	10	10	10	10		10		10	10	
Gauze, 4 x 8 in., 12-ply, x-ray						10		10			
Lid for 2 oz. medicine cup	1	1	1	1	1	1	1	1	1	1	1
Light handle covers, flexible	2	2		2	2	2			2	2	
Light handle covers, rigid			2				2	2			
Medicine cup, 2 oz.	1	1	1	1	1	1	1	1	1	1	1
Needle counter, 20-40 count, foam block, magnet, blade disarmer											1
Needle counter, 40-70 count, foam block, magnet, blade disarmer	1	1	1					1			
Needle counter, 40-100 count, foam block, double magnets				1	1	1	1		1	1	
Scalpel holder	1	1	1	1				1	1		
Skin marker, with ruler and 9 labels	1	1	1	1	1	1	1	1	1	1	1
Specimen container, 4½ in., with screw lid	1	1	1	1	1	1	1	1	1	1	1
Sponges, lap, 18 x 18 in.	5	5	5	5		5		5	5	5	5
Suction handle, bulbous tip, non-vented	1	1	1	1	1	1	1	1	1	1	1
Suction tubing, 6 mm x 12 ft.	1	1	1	1	1	1	1	1		1	
Suction tubing, 6 mm x 20 ft.									1		1
Surgical blade, #15, carbon steel	1	1	1	1				1	1		1
Surgical blades, #10, carbon steel	2	2	2	2				2			
Surgical blades, #10, stainless steel									2		2
Syringe, asepto, 50 cc	1	1	1	1	1	1	1	1	1	1	1
Towels, blue, cotton											



SSK3004 (see page 85)



SSK6002 (see page 87)

OR Accessories

OR Setup and Basin Kits

Minor Single Basin

	13752-630	13752-632	SSK3004	SSK3005	SSK3006
Kit Number					
Case Quantity	5	5	6	6	6
Bedside bag					1
Cautery tip cleaner					1
CSR wrap, 54 x 54 in.	2	2	1	2	1
Emesis basin, 700 cc	1	1	1	1	1
Lid for 2 oz. medicine cup			1	1	1
Light handle covers, flexible					2
Light handle covers, rigid		2			
Medicine cup, 2 oz.	1	1	1	1	1
Needle counter, 40-70 count, foam block, magnet, blade disarmer					1
Ring basin, 7 qt.	1	1	1	1	1
Skin marker, with ruler and 9 labels					1
Specimen container, 4½ in., with screw lid			1	1	1
Sponge bowl, 32 oz.	1	1	1	1	1

Minor Double Basin

	13752-610	13752-611	13752-612	13752-613	SSK5001	SSK5002	SSK5004
Kit Number							
Case Quantity	5	5	10		5	5	5
CSR wrap, 54 x 54 in.	2		2				
CSR wrap, 54 x 72 in.		2		1	1	2	2
Emesis basin, 700 cc	2	1	2	1	1	1	1
Lid for 2 oz. medicine cup					1	1	1
Light handle covers, flexible							2
Light handle covers, rigid			2				
Medicine cup, 2 oz.	2	2	2		1	1	1
Needle counter, 40-70 count, foam block, magnet, blade disarmer							
Pitcher, 1,200 cc		1		1	1	1	1
Ring basin, 7 qt.	2	2	2	1	2	2	2
Skin marker, with ruler and 9 labels							
Specimen container, 4½ in., with screw lid					1	1	1
Sponge bowl, 32 oz.	2	2	2	1	1	1	1

OR Setup and Basin Kits

Major Single Basin

Kit Number	SSK4001	SSK4002	SSK4003	SSK4005	SSK4006	SSK4009A	SSK9041A	SSK9042A	SSK9046A	SSK9047A
Case Quantity	5	4	3	4	3	4	4	6	8	4
Back table cover, 50 x 47 in.						1				
Back table cover, 65 x 90 in.			1		1		1	1		1
Bedside bag	1	1	1	1	1	1	1	1	1	1
Cautery pencil, push button, with blade and holster							1	1		1
Cautery pencil, rocker switch, with blade and holster		1	1	1	1					
Cautery tip cleaner	1	1	1	1	1	1	1		1	
CSR wrap, 54 x 54 in.	1	1	1	1	1				1	
Emesis basin, 700 cc	1	1	1	1	1	1	1	1	1	1
Gauze, 4 x 4 in., 16-ply, x-ray	10	10	10	10	10	10	10	10	10	10
Gown, X-Large			1		1					
Gown, X-Large, with towel			1		1					
Lid for 2 oz. medicine cup	1	1	1	1	1	1	1	1	1	1
Light handle covers, flexible	2	2	2			2	2			
Light handle covers, rigid				2	2				2	2
Mayo stand cover, 23 in.			1		1		1	1		1
Medicine cup, 2 oz.	1	1	1	1	1	1	1	1	1	1
Needle counter, 30-60 count, foam strip, magnet, blade disarmer									1	
Needle counter, 40-70 count, foam block, magnet, blade disarmer	1	1	1	1	1	1				
Needle counter, 40-100 count, foam block, double magnets							1	1		1
Pitcher, 1,200 cc	1	1	1	1	1	1				
Ring basin, 7qt.	1	1	1	1	1	1	1	1	1	1
Scalpel holder	1	1	1	1	1	1	1	1		1
Skin marker, with ruler and 9 labels	1	1	1	1	1	1	1	1	1	1
Specimen container, 4½ in., with screw lid	1	1	1	1	1	1	1	1	1	1
Sponge bowl, 1,500 cc, purple, heart shape							1	1	1	1
Sponge bowl, 32 oz.	1	1	1	1	1					
Sponge bowl, 48 oz.						1				
Sponges, lap, 18 x 18 in.	5	5	5	5	5	5	5	5	5	5
Suction handle, bulbous tip, non-vented	1	1	1	1	1	1	1	1	1	1
Suction tubing, 6 mm x 12 ft.	1	1	1	1	1	1			1	1
Suction tubing, 6 mm x 20 ft.							1	1		
Surgical blade, #15, carbon steel	1	1	1	1	1	1	1		1	1
Surgical blades, #10, carbon steel	2	2	2	2	2	2			2	
Surgical blade, #10, stainless steel							2			1
Syringe, asepto, 50 cc	1	1	1	1	1	1	1	1		1
Towels, blue, cotton		6	6	6	6	4	4	4		4

OR Accessories

OR Setup and Basin Kits

Major Double Basin	28025-100	28025-200	SSK6001	SSK6002	SSK6003	SSK6006	SSK6011A	SSK6013A
Kit Number								
Case Quantity	3	3	3	3	3	3	3	3
Back table cover, 44 x 75 in.		1						
Back table cover, 50 x 90 in.							1	1
Back table cover, 65 x 90 in.					1	1		
Bedside bag			1	1	1	1	1	1
Cautery pencil, push button, with blade and holster							1	1
Cautery pencil, rocker switch, with blade and holster		1		1	1	1		
Cautery tip cleaner	1	1	1	1	1	1	1	1
CSR wraps, 54 x 54 in.	2							
CSR wrap, 54 x 72 in.			1	1	1	1		
Emesis basin, 700 cc	1	1	1	1	1	1	2	2
Foam tray protector, 22 x 28 x 1/16 in.		1						
Gauze, 4 x 4 in., 16-ply, x-ray	10	10	10	10	10	10	10	10
Gown, X-Large					1	1		
Gown, X-Large, with towel					1	1		
Lid for 2 oz. medicine cup		2	1	1	1	1	1	1
Lid for 32 oz. bowl		1						
Light handle covers, flexible			2	2	2			2
Light handle covers, rigid		2				2	2	
Mayo stand cover, 23 in.					1	1		1
Medicine cup, 2 oz.	2	2	1	1	1	1	1	1
Needle counter, 15-30 count, double magnet	1							
Needle counter, 15-30 count, foam strip, magnet		1						
Needle counter, 40-100 count, foam block, double magnet			1	1	1	1	1	1
Pitcher, 1,200 cc	1	1	1	1	1	1	1	1
Ring basins, 7 qt.	2	2	2	2	2	2	2	2
Scalpel holder			1	1	1	1	1	1
Skin marker, with ruler and 9 labels			1	1	1	1	1	1
Specimen container, 4½ in., with screw lid		1	1	1	1	1	1	1
Sponge bowl, 32 oz.	2	1	2	2	2	2		
Sponge bowls, 48 oz.							2	2
Sponge bowl, 64 oz.		1						
Sponges, lap, 18 x 18 in.	10	5	10	10	10	10	10	10
Suction handle, bulbous tip, non-vented	1	1	1	1	1	1	1	1
Suction tubing, 6 mm x 12 ft.	1	1	1	1	1	1	1	1
Surgical blade, #15, carbon steel			1	1	1	1	1	1
Surgical blades, #10, carbon steel		2	2	2	2	2	2	2
Syringe, asepto, 50 cc	1	1	1	1	1	1	1	1
Towels, blue, cotton				8	8	8		8

OR Clean Up and Procedure Room Turnover Kits

OR Cleanup Kits



Clean Up Kit with Microfiber Mop

Case Quantity: 12

Cat. No.	Contents	Quantity
ORC999OR6	<i>Combo Pack #1 plus</i>	
	Bag, drawtape, blue, 40 x 40 in.	1
	Bag, drawtape, clear, 40 x 40 in.	2
	Bag, drawtape, red, 40 x 40 in.	1
	Liner, kickbucket, red, 23 x 24 in.	2
	Mop head, microfiber	1
	Trash can liner, clear, 33 x 38 in.	2
	Washcloth, 11 x 13 in.	2

Clean Up Combo Pack #1

Case Quantity: 30

Cat. No.	Contents	Quantity
ORC999OR1A	Armboard Covers with Straps, 13 x 30 in.	2
	Draw/Lift Sheet, 40 x 80 in.	1
	Head Positioner Cover, 14 x 15 in.	1
	Table Sheet, 40 x 90 in.	1

Clean Up Kit with Rayon Mop

Case Quantity: 12

Cat. No.	Contents	Quantity
ORC999OR4	<i>Combo Pack #1 plus</i>	
	Bag, drawtape, blue, 40 x 40 in.	1
	Bag, drawtape, clear, 40 x 40 in.	2
	Bag, drawtape, red, 40 x 40 in.	1
	Liner, kickbucket, red, 23 x 24 in.	2
	Mop head, rayon, 16 oz., No fantail	1
	Trash can liner, clear, 33 x 38 in.	2
	Washcloth, 11 x 13 in.	2

Clean Up Kit with Cotton Mop

Case Quantity: 12

Cat. No.	Contents	Quantity
ORC999OR10	<i>Combo Pack #1 plus</i>	
	Bag, drawtape, blue, 40 x 40 in.	1
	Bag, drawtape, clear, 40 x 40 in.	2
	Bag, drawtape, red, 40 x 40 in.	1
	Liner, kickbucket, red, 23 x 24 in.	2
	Mop head, polyester strip, 12 oz.	1
	Trash can liner, clear, 33 x 38 in.	2
	Washcloth, 11 x 13 in.	2

All products listed on this page are not made with natural rubber latex.

OR Clean Up and Procedure Room Turnover Kits

OR Cleanup Kits



Clean Up Combo Pack #2

Case Quantity: 30

Cat. No.	Contents	Quantity
ORC999OR2A	Armboard Covers with Straps, 13 x 30 in.	2
	Draw/Lift Sheet , 40 x 80 in.	1
	Table Sheet, 40 x 90 in.	1

Clean Up Kit with Drawcord Bags

Case Quantity: 20

Cat. No.	Contents	Quantity
ORC999OR7A	<i>Combo Pack #2 plus</i>	
	Drawcord Bag, Blue, 38 x 38 in.	2
	Drawcord Bag, Clear, 38 x 38 in.	2

Clean Up Kit with Drawcord Bags and Patient Strap

Case Quantity: 20

Cat. No.	Contents	Quantity
ORC999OR8	<i>Combo Pack #2 plus</i>	
	Drawcord Bag, Blue, 38 x 38 in.	2
	Drawcord Bag, Clear, 38 x 38 in.	2
	Liner, Kickbucket, Red, 23 x 24 in.	1
	Strap, Patient, 43 x 3 in.	1

Clean Up Kit with Drawcord and Drawtape Bags and Rayon Mop

Case Quantity: 12

Cat. No.	Contents	Quantity
ORC999OR9	<i>Combo Pack #2 plus</i>	
	Drawtape Bag, Blue, 40 x 40 in.	2
	Drawcord Bag, Clear, 38 x 38 in.	2
	Liner, Kickbucket, Red, 23 x 24 in.	1
	Mop Head, Rayon, 16oz., No Fantail	1
	Trash Liner, Clear, 33 x 38 in.	1

Clean Up Kit with Rayon Mop

Case Quantity: 20

Cat. No.	Contents	Quantity
ORC999OR12	<i>Combo Pack #2 plus</i>	
	Mop Head, Rayon, 12oz., No Fantail	1
	Washcloth, 11 x 13 in.	2

Clean Up Kit with Rayon Mop and Drawtape Bags

Case Quantity: 15

Cat. No.	Contents	Quantity
ORC999OR13	<i>Combo Pack #2 plus</i>	
	Bag, Drawtape, Clear, 40 x 40 in.	1
	Bag, Drawtape, Blue, 40 x 40 in.	1
	Bag, Drawtape, Red, 40 x 40 in.	1
	Liner, Kickbucket, Red, 23 x 24 in.	1
	Mop Head, Rayon, 12oz., No Fantail	1
	Washcloth, 11 x 13 in.	2

Clean Up Kit with Washcloth

Case Quantity: 12

Cat. No.	Contents	Quantity
ORC999OR11	<i>Combo Pack #2 plus</i>	
	Washcloth, 11 x 13 in.	2



Clean Up Combo Pack #3

Case Quantity: 40

Cat. No.	Contents	Quantity
ORC999OR3A	Draw/Lift Sheet, 40 x 80 in.	1
	Table Sheet, 40 x 90 in.	1

All products listed on this page are not made with natural rubber latex.

Single Shot Epidural Trays

	Single Shot 20G Epidural with Glass Syringe	Single Shot 18G Epidural with Filter Straw	Double Single Shot 20G Epidural Tray	Single Shot 18G Epidural with Filter Needle	Single Shot 22G Epidural Tray	Single Shot 20G Epidural Tray	Single Shot 18G Epidural with Loss of Resistance Syringe	Single Shot 20G Epidural without Extension Set
Cat. No.	34PAIN02	34PAIN03	34PAIN04	34PAIN06	34PAIN07	34PAIN10	34PAIN11	34PAIN13
Case Quantity	10	10	20	10	10	10	10	10
CSR wrap, 30 x 30 in.	1	1	1	1	1	1	1	1
Drape, poly lined, 18 x 26 in., 4 in. fenestration	1	1			1			1
Drape, poly lined, 24 x 30 in., 4 in. fenestration			2	1		1		
Filter straw, 5 micron, 4 in.		1	2			1		
Foam needle block	1	1	2	1	1	1	1	1
Foam sponge stick	3	3		3	3	3	3	3
Gauze, 3 x 3 in., 4-ply, non-woven,				3	1	3		
Gauze, 3 x 3 in., 12-ply			1					
Gauze, 4 x 4 in., 8-ply	4	4					4	3
Label sheet, 54	1	1	1	1	1	1	1	1
Lidocaine, 2%, glass ampule, 5 mL	2	1	2	2	1	2	2	1
Medicine cup, 2 oz.		1						
Needle, epidural, 22G x 3½ in.					1			
Needle, epidural, detachable, 20G x 3½ in.	1		2			1		1
Needle, epidural, fixed, 18G x 3½ in.		1		1			1	
Needle, filter 19G x 1½ in.				1				
Needle, hypodermic, 18G x 1½ in.	1	1	4	2	1	2	1	1
Needle, hypodermic, 19G x 1½ in.								1
Needle, hypodermic, 22G x 1½ in.		1					1	1
Needle, hypodermic, 25G x ¾ in.		1						
Needle, hypodermic, 25G x 1½ in.	1				1			1
Needle, hypodermic, 27G x 1¼ in.			2	1		1		
Needle, hypodermic, 30G x ½ in.							1	
PVP, foil, 10%, ¾ oz.	1	1		1	1	1	1	1
Sodium chloride, 0.9%, glass ampule 10 mL	1	1	2	1		1	1	1
Syringe, LOR, Glass, 5 mL	1	1		1				1
Syringe, luer lock, 3 mL	1	1	4	1		1		1
Syringe, luer lock, 5 mL	1		2		3		1	
Syringe, luer lock, 10 mL	1		2	1		2		1
Syringe, luer lock, 20 mL		1					1	1
Syringe, luer lock, Low resistance, 7 mL					1		1	
Syringe, luer slip, Low resistance, 7 mL			2					
Towel, absorbent, 15½ x 22½ in.	1	1	2	1			1	1
Tubing, extension set, 6 in.	1					1		
Tubing, extension set, small bore, 20 in.			2					

All products listed on this page are not made with natural rubber latex.

Pain Management

Standard Kits

Nerve Block Trays

	Cat. No.	Basic Single Nerve Block with Drug and Extension Set	Single Shot Nerve Block 22G Spinal Needle
		34PAIN09	34PAIN15
	Case Quantity	10	10
CSR wrap, 30 x 30 in.		1	1
Drape, adhesive, 19 x 30 in.		1	2
Foam needle block		1	1
Foam sponge stick		3	3
Gauze, 3 x 3 in., 12-ply		6	
Gauze, 4 x 4 in., 12-ply			1
Label sheet, 54		1	1
Lidocaine, 2%, glass ampule, 5 mL		2	1
Marker, regular tip, violet		1	
Needle, filter 19G x 1½ in.			1
Needle, hypodermic, 18G x 1½ in.		1	2
Needle, hypodermic, 22G x 1½ in.		1	
Needle, hypodermic, 25G x ¾ in.		1	
Needle, hypodermic, 25G x 1½ in.		1	1
Needle, hypodermic, 27G x 1¼ in.			1
Needle, Quincke, spinal, 22G x 3½ in.			3
PVP, foil, 10%, ¾ oz.		1	1
Syringe, luer lock, 3 mL		1	
Syringe, luer lock, 10 mL		1	3
Towel, non-absorbent with adhesive		1	1
Tubing, extension set, 6 in.		1	1

All products listed on this page are not made with natural rubber latex.

Pain Management

Standard Kits

Universal Block Trays with and without Drugs

	Universal Block No Drugs Fenestrated Paper Drape	Universal Block Tray with Drugs	Universal Block No Drugs Fenestration Clear Drape	Universal Block No Drugs with 6 in. Extension Set and Loss of Resistance Syringe	Universal Block 2 Location No Drug
Cat. No.	34PAIN01	34PAIN05	34PAIN08	34PAIN12	34PAIN14
Case Quantity	25	10	10	10	10
CSR wrap, 24 x 24 in.					1
CSR wrap, 30 x 30 in.	1	1	1	1	
Drape, poly lined, 18 x 26 in., 4 in. fenestration	1		1		2
Drape, poly lined, 24 x 30 in., 4 in. fenestration		1		1	
Foam needle block	1	1	1	1	2
Foam sponge stick	2	3	3	3	
Gauze, 4 x 4 in., 8-ply	4		4		1
Gauze, 4 x 4 in., 12-ply		4		4	
Label sheet, 54	1	1	1	1	1
Lidocaine, 2%, glass ampule, 5 mL		2			
Marker, regular tip, violet				1	
Needle, filter 19G x 1½ in.		1			
Needle, hypodermic, 18G x 1½ in.	2	1	1		2
Needle, hypodermic, 19G x 1½ in.				1	
Needle, hypodermic, 25G x 1½ in.		1	1	1	2
Needle, hypodermic, 27G x 1¼ in.	1	1	1		
PVP, foil, 10%, ¾ oz.	1	1	1		
PVP, foil, 10%, 3 pack					2
Syringe, luer lock, 3 mL	1	1	2		2
Syringe, luer lock, 5 mL	1	1	1	1	
Syringe, luer lock, 10 mL	1	2	1	2	2
Syringe, luer slip, Low resistance, 7 mL				1	
Towel, absorbent, 15½ x 22½ in.		1	1	1	2
Tubing, extension set, 6 in.				1	
Tubing, extension set, 12 in.		1			

All products listed on this page are not made with natural rubber latex.

Personal Protection Equipment

Chemotherapy Kit



Chemotherapy Kit

Case Quantity: 50

Cat. No.	Contents	Quantity
CHE90STDZA	Exam gloves - Esteem®, medium, 12 in. length with extended cuff	2
	Fluid control mat, ChemoPlus™, 16 x 22 in.	1
	Isolation gown, Safecare®	1
	Transport bag with Safelock™, 12 x 15 in., 4mil	1

Chemotherapy Kit

All products listed on this page are not made with natural rubber latex.

Personal Protection Equipment

Personal Protection Equipment (PPE) Kits



PPE Barrier Kit*

Case Quantity: 45

Cat. No.	Contents	Quantity
ISO99PPEB	Bouffant cap, spun bonded, large	1
	Exam gloves - Esteem®, nitrile, medium	2
	Face mask with fluid resistant Insta-Guard® shield	1
	Isolation gown with knit cuff, half back, universal size	1
	Shoe covers, poly-coated ankle-high, universal size	2

*PPE Barrier Kit also available in a 2 kit/case configuration: Catalog No. ISO99PPEB2

PPE with Coveralls Kit

Case Quantity: 40

Cat. No.	Contents	Quantity
ISO99PPEWC	Bouffant cap, spun bonded, large	1
	Coverall, fluid resistant, X-large	1
	Exam gloves - Esteem®, nitrile, medium	2
	Face mask w/fluid resistant Insta-Guard® shield	1
	Shoe covers, critical zone, X-large	2



PPE Basic Kit

Case Quantity: 20

Cat. No.	Contents	Quantity
ISO99BPPE	Bouffant cap, spun bonded, large	1
	Exam gloves - Esteem®, nitrile, medium	2
	Face mask with fluid resistant Insta-Guard® shield	1
	Isolation gowns with ties, X-large	2
	Shoe covers, non-skid, X-large	2

PPE Maximum Barrier Kit

Case Quantity: 30

Cat. No.	Contents	Quantity
ISO99PPEMA	Apron, plastic film, universal size	1
	Biohazard bag 38 x 45 in., 1.2mL	1
	Exam glove - Esteem®, nitrile, powder free, medium	2
	Face shield, full length, 1-piece with foam headband, universal size	1
	Isolation gown with knit cuff and waist tie, universal size	1
	Kleenguard® hood A60, universal size	1
	Secure-Gard® Mask, respirator, medium/large	1
	Shoe covers, hi-top, X-large	2

All products listed on this page are not made with natural rubber latex.

Standard Surgical Kits

ENT – Head and Neck I, Head and Neck II

Core components included in Head and Neck I, Head and Neck II kits

Contents	Quantity
Back table cover, 50 x 90 in.	1
Bedside bag	1
Blade, #10, carbon steel	1
Blade, #15, carbon steel	1
Dressing, non-adherent, 3 x 8 in.	1
Gauze, 4 x 4 in., 16-ply, x-ray	10
Gown, Astound®, X-Large	1
Gown, Astound®, X-Large with towel	1
Labels, preprinted ENT, waterproof, 22/sheet	1
Marker, dual-tip	1
Mayo stand cover, 23 in.	1
Medicine cups, 2 oz.	2
Needle counter, 20-40 count, foam block, magnet	1
Needle, 18G x 1½ in.	1
Needle, 25G x 1½ in.	1
Ruler, 6 in., flexible	1
Specimen container, 4½ oz., with screw lid	1
Sponge bowls, 32 oz.	2
Sponges, lap, 18 x 18 in., x-ray	5
Suction tubing, 6 mm x 12 ft.	1
Syringe, asepto, 50 cc	1
Syringe, luer lock, 10 mL	1
Towels, cotton	6
Towels, low lint	4
Yankauer suction handle, bulbous tip, non-vented	1



Head and Neck I

Case Quantity: 4

Cat. No.	Contents	Quantity
SPP99HN9AA	<i>core components</i> plus	
	Drape, half sheet, 40 x 57 in.	1
	One-compartment tray, blue	1



Head and Neck II

Case Quantity: 3

Cat. No.	Contents	Quantity
SPP99HN10A	<i>core components</i> plus	
	Basin, emesis, 700 cc	1
	Basin, ring, 5,500 cc	1
	CSR wrap, 54 x 54 in.	1
	Drape, half sheet, 40 x 57 in.	1
	Drape, head/bar, 42 x 34 in.	1
	Drape, split sheet, 77 x 110 in.	1
	Gauze, 4 x 4 in., 16-ply, x-ray	10
	Gown, Astound®, X-Large	1
	Pitcher, specimen, 1,200 cc	1

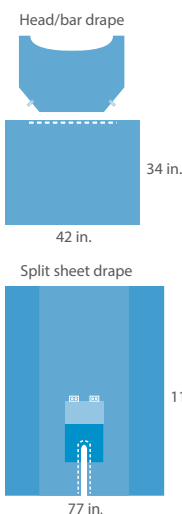

Basic drape fabric	Reinforcements	Side panel material
Adhesive	Incise	Clear plastic panels and pouches

All products listed on this page are not made with natural rubber latex.

Standard Surgical Kits

ENT – Nasal and Sinus, Nosebleed

Core components included in Nasal and Sinus, T&A I, T&A II kits

Contents	Quantity
Back table cover, 50 x 90 in.	1
Bedside bag	1
Gauze, 4 x 4 in., 16-ply, x-ray	10
Gown, Astound®, X-Large	1
Gown, Astound®, X-Large with towel	1
Mayo stand cover, 23 in.	1
Medicine cup, 2 oz.	1
Needle counter, 10-20 count, foam block, magnet	1
Specimen container, 4½ oz., with screw lid	1
Sponge bowl, 32 oz.	1
Suction tubing, 6 mm x 12 ft.	1
Towels, cotton	3
Towels, low lint	2
Yankauer suction handle, bulbous tip, non-vented	1

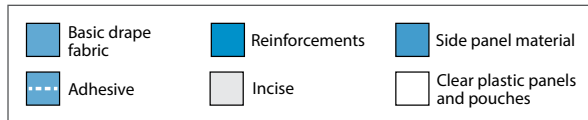

All products listed on this page are not made with natural rubber latex.

Nasal and Sinus

Case Quantity: 4

Cat. No.
SPP99NA2AA

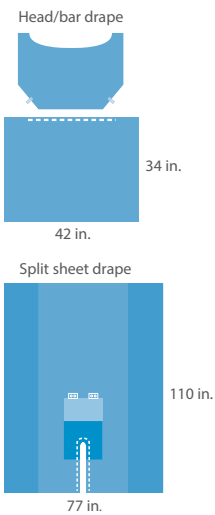

Contents	Quantity
<i>core components plus</i>	
Basin, emesis, 700 cc	1
Cotton tip applicators, 6 in.	6
Drape, head/bar, 42 x 34 in.	1
Drape, split sheet, 77 x 110 in.	1
Gauze, 4 x 4 in., 12-ply, non x-ray	10
Labels, preprinted ENT, waterproof, 22/sheet	1
Marker, dual-tip	1
Medicine cup, 2 oz.	1
Needle, 25G x 1½ in.	1
One-compartment tray, blue	1
Ruler, 6 in., flexible	1
Syringe, bulb, 3 oz.	1
Syringes, luer lock, 10 mL	2
Tongue depressor	1
Towel, cotton	1
Zipper bag	1

Nosebleed

Case Quantity: 30

Cat. No.	Contents	Quantity
12-0160	Cotton balls, large	3
	CSR wrap, 30 x 30 in.	1
	Gauze, 4 x 4 in., 8-ply	5
	Instrument, ear lucae forceps, 5½ in.	1
	Instrument, nasal speculum	1
	Instrument, scissors, iris, 4½ in., straight	1
	Label, change date, 1 x 2 in.	1
	Medicine cups, 2 oz.	2
	One-compartment tray	1
	Suction handle, Frazier, 10 Fr., vented	1

Nosebleed

Case Quantity: 30

Cat. No.	Contents	Quantity
12-0209	CSR wrap, 30 x 30 in.	1
	Foam tray	1
	Gauze, 2 x 2 in., 12-ply	5
	Instrument, ear lucae forceps, 5½ in.	1
	Instrument, nasal speculum, 5½ in.	1
	Suction handle, Frazier, 10 Fr., vented	1

Standard Surgical Kits

ENT – T&A I, T&A II



T&A I

Case Quantity: 4

Cat. No.
SPP99TA5AA

Contents	Quantity
<i>core components</i> plus	
Drapes, half sheet, 40 x 57 in.	2
Labels, blank, standard	3
Marker, utility	1
Sponges, tonsil, 7/8 in., x-ray	5



T&A II

Case Quantity: 4

Cat. No.
SPP99TA6AA

Split sheet drape

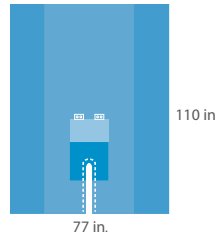

Contents	Quantity
<i>core components</i> plus	
Drape, split sheet, 77 x 110 in.	1
Labels, blank, standard	3
Marker, utility	1
Sponges, tonsil, 7/8 in., x-ray	5

Basic drupe fabric	Reinforcements	Side panel material
Adhesive	Incise	Clear plastic panels and pouches

All products listed on this page are not made with natural rubber latex.

Standard Surgical Kits

General Surgery – Laparoscopy

Core components included in General Surgery – Laparoscopy kits

Contents	Quantity
Bedside bag	1
Blade, #11, rib back, carbon steel	1
Gauze, 4 x 4 in., 16-ply, x-ray	1
Mayo stand cover, 23 in.	1
Syringe, luer lock, 10 mL	1
Tubing, insufflation, 12 ft., 0.1um, fixed luer	1



General Laparoscopy

Case Quantity: 2

Cat. No.
SPP99GL2AA

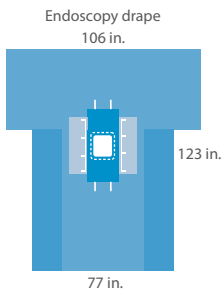

Contents	Quantity
<i>core components plus</i>	
Back table cover, heavy duty, 60 x 90 in.	1
Basin, emesis, 700 cc	1
Basin, ring, 5500 cc	1
Blade, #15, carbon steel	1
CSR wrap, 54 x 54 in.	1
Drape, endoscopy, fenestrated with pouches, 106 x 123 x 77 in.	1
Fog inhibitor	1
Gown, Astound®, X-Large	2
Gown, Astound®, X-Large with towel	1
Labels, preprinted OR, waterproof, 30/sheet	1
Marker, dual-tip	1
Medicine cup, 2 oz.	2
Needle, 22G x 1½ in.	1
Needle, 25G x 1½ in.	1
Needle counter, 20-40, foam block, magnet	1
Ruler, 6 in., flexible	1
Specimen container, 4½ in., with screw lid	1
Sponge bowl, 32 oz.	1
Sponges, lap, 18 x 18 in., x-ray	1
Suction tubing, 6 mm x 12 ft.	1
Towel, cotton	6
Towel, low lint	2

Laparoscopy

Case Quantity: 2

Cat. No.
SPP99LS2AA

Contents	Quantity
<i>core components plus</i>	
Adhesive bandage, fabric, 2 x 3¾ in.	1
Adhesive bandage, plastic, 1 x 3 in.	3
Back table cover, heavy duty, 60 x 90 in.	1
Drape, laparoscopy, fenestrated, 38 x 97 x 97 in.	1
Drape, under buttocks with cuff, 36 x 49 in.	1
Fog inhibitor	1
Gowns, Astound®, fabric reinforced, X-Large	1
Gown, Astound®, X-Large with towel	1
Label, sheet of 3, ½ x 2 in.	2
Legging, lithotomy with 6in cuff, 31½ x 48 in.	2
Marker, regular tip, violet	1
Medicine cup, 2 oz.	1
Needle counter, 20-40, foam block, magnet	1
OB pad with wings, adhesive	1
One-compartment tray	1
Ruler, 6 in., flexible	1
Specimen container, 4½ in., with screw lid	1
Towel, cotton	6
Tubing, insufflation, 12 ft., 0.1um, fixed luer	1

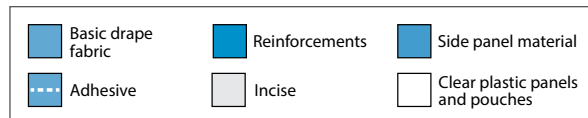

All products listed on this page are not made with natural rubber latex.

Standard Surgical Kits

General Surgery – Laparoscopy

Laparoscopy

Case Quantity: 2

Cat. No.	Contents	Quantity
SPP99LS3AA	<i>core components plus</i>	
	Adhesive bandage, plastic, 1 x 3 in.	1
	Back table cover, 50 x 90 in.	1
	Blade, #15, carbon steel	1
	Catheter, 14FR, tapered end	1
	Drape, chest/breast with armboards, 102 x 121 x 77 in.	1
	Drape, under buttocks with cuff, 36 x 49 in.	1
	Gown, Astound®, large	1
	Gown, Astound®, X-Large	1
	Legging, lithotomy with folded corner, 28½ x 42¾ in.	2
	Needle, 22G x 1½ in.	1
	OB pad with wings, adhesive	1
	Sponge bowl, 32 oz.	1
	Towel, absorbent	1
	Towel, cotton	4
	Tubing, insufflation, 12 ft., 0.1 um, fixed luer	1
	Wet skin scrub prep kit	1

Laparoscopy Plus II Pack 070*

Case Quantity: 3

Cat. No.	Contents	Quantity
SPP99LS1AA	<i>*Does not include core components with this kit</i>	
	Adhesive bandage, fabric, 2 x 3¾ in.	1
	Adhesive bandage, plastic, 1 x 3 in.	3
	Back table cover, heavy duty, 60 x 90 in.	1
	Basin, Emesis, 700 cc	1
	Bedside bag	1
	CSR wrap, 54 x 54 in.	1
	Drape, laparoscopy, fenestrated, 38.5 x 97 x 99.5 in.	1
	Drape, under buttocks with cuff, 36 x 49 in.	1
	Fog inhibitor	1
	Gauze, 4 x 4 in., 16-ply, x-ray	1
	Gown, Astound®, X-Large with towel	1
	Gowns, Astound®, fabric reinforced, X-Large	1
	Insufflation tubing, 12 ft.	1
	Label, sheet of 3, ½ x 2 in.	2
	Legging, lithotomy with 6 in. cuff, 31½ x 48 in.	2
	Marker, regular tip, violet	1
	Mayo stand cover, 23 in.	1
	Medicine cup, 2 oz.	1
	Needle counter, 20-40, foam block, magnet	1
	OB pad with wings, adhesive	1
	Ring basin, 7 qt.	1
	Ruler, 6 in., flexible	1
	Specimen container, 4½ in., with screw lid	1
	Sponge bowl, 32 oz.	1
	Surgical blade, #11, rib back, carbon steel	1
	Syringe, luer lock, 10 mL	1
	Towel, cotton	6

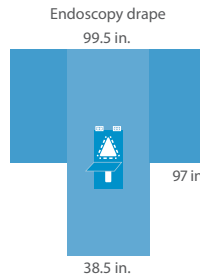

	Basic drape fabric		Reinforcements		Side panel material
	Adhesive		Incise		Clear plastic panels and pouches

All products listed on this page are not made with natural rubber latex.

Standard Surgical Kits

General Surgery – Laparotomy

Core components included in General Surgery – Laparotomy, Minor Procedure and Universal kits

Contents	Quantity
Basin, emesis, 700 cc	1
Bedside bag	1
Blade, #15, carbon steel	1
Gauze, 4 x 4 in., 16-ply, x-ray	10
Labels, preprinted OR, waterproof, 30/sheet	1
Marker, dual-tip	1
Mayo stand cover, 23 in.	1
Medicine cups, 2 oz.	2
Needle, 22G x 1½ in.	1
Needle, 25G x 1½ in.	1
Ruler, 6 in., flexible	1
Specimen container, 4½ oz., with screw lid	1
Sponge bowl, 32 oz.	1
Suction tubing, 6 mm x 12 ft.	1
Syringe, luer lock, 10 mL	1
Towels, cotton	4
Towel, low lint	1







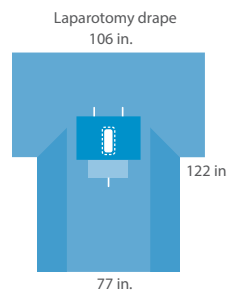

Laparotomy

Case Quantity: 2

Cat. No.
SPP99LA1AA



Contents	Quantity
<i>core components plus</i>	
Back table cover, 60 x 90 in.	1
Basin, ring, 5,500 cc	1
Blades, #10, carbon steel	2
CSR wrap, 54 x 54 in.	1
Drape, laparotomy with armboards, 106 x 122 x 77 in.	1
Gown, Astound®, fabric reinforced, X-Large with towel	1
Gowns, SmartSleeve™, X-Large	2
Needle counter, 40-70 count, foam block, magnet	1
Pitcher, specimen, 1,200 cc	1
Sponges, lap, 18 x 18 in., x-ray	10
Syringe, asepto, 50 cc	1
Towels, cotton	2
Towels, low lint	3
Towels, non-absorbent with adhesive	4
Yankauer suction handle, bulbous tip, non-vented	1

 Basic drape fabric	 Reinforcements	 Side panel material
 Adhesive	 Incise	 Clear plastic panels and pouches

All products listed on this page are not made with natural rubber latex.

Standard Surgical Kits

General Surgery – Minor Procedure, Universal, Universal Pack



Minor Procedure

Case Quantity: 4

Cat. No.
SPP99MN7AA

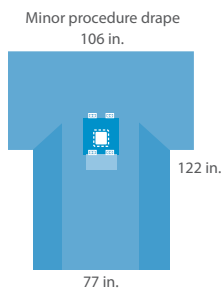

Contents	Quantity
<i>core components plus</i>	
Back table cover, 50 x 90 in.	1
Blade, #15, carbon steel	1
Drape, minor procedure with armboards, 106 x 122 x 77 in.	1
Gown, Astound®, X-Large	1
Gown, Astound®, X-Large with towel	1
Needle counter, 10-20 count, foam block, magnet	1
Syringe, asepto, 50 cc	1
Yankauer suction handle, bulbous tip, non-vented	1

Universal

Case Quantity: 2

Cat. No.
SPP99UN1AA

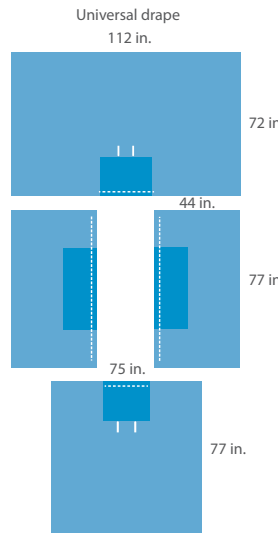

Contents	Quantity
<i>core components plus</i>	
Back table cover, 60 x 90 in.	1
Basin, ring, 5,500 cc	1
Blades, #10, carbon steel	2
CSR wrap, 54 x 54 in.	1
Drape, foot sheet, 75 x 77 in.	1
Drape, head sheet, 112 x 72 in.	1
Drapes, side sheet, 44 x 77 in.	2
Gown, Astound®, fabric reinforced, X-Large with towel	1
Gowns, SmartSleeve™, X-Large	2
Needle counter, 40-70 count, foam block, magnet	1
Pitcher, specimen, 1,200 cc	1
Sponges, lap, 18 x 18 in., x-ray	10
Syringe, asepto, 50 cc	1
Towels, low lint	3
Towels, non-absorbent with adhesive	4
Yankauer suction handle, bulbous tip, non-vented	1

Universal Pack*

Case Quantity: 4

Cat. No.
29108

**Does not include core components with this kit*

Contents	Quantity
Back table cover, heavy duty, 60 x 90 in.	1
Bedside bag	1
Drape, foot, universal, 72 x 75 in.	1
Drape, head sheet, universal, reinforced, 53 x 99 in.	1
Drapes, universal, pouch, 38 x 77 in.	2
Gowns, Astound®, large	3
Mayo stand cover, 23 in.	1
Suction tubing, 6 mm x 9 ft.	1
Towels, absorbent	2
Towels, non-absorbent with adhesive	4
Transfer wrap, 23½ x 23½ in.	1
Yankauer suction handle, bulbous tip, non-vented	1

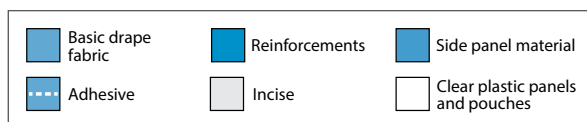

All products listed on this page are not made with natural rubber latex.

Standard Surgical Kits

Neurosurgery – Laminectomy I, Laminectomy II

Core components included in Laminectomy I, Laminectomy II, Neurosurgery kits

Contents	Quantity
Back table cover, 60 x 90 in.	1
Bedside bag	1
Blade, #10, carbon steel	1
Blade, #15, carbon steel	1
Bone wax	1
Gauze, 4 x 4 in., 16-ply, x-ray	20
Labels, preprinted Neurology, waterproof, 30/sheet	1
Marker, dual-tip	1
Mayo stand cover, 23 in.	1
Medicine cups, 2 oz.	2
Needle counter, 20-40 count, foam block, magnet	1
Needle, hypodermic, 22G x 1 1/2 in.	1
Needle, spinal, 18G x 3 1/2 in.	1
Ruler, 6 in., flexible	1
Specimen container, 4 1/2 oz., with screw lid	1
Sponge bowl, 32 oz.	1
Sponges, lap, 18 x 18 in., x-ray	5
Sponges, neuro, 1/2 x 1/2 in., x-ray	10
Sponges, neuro, 1 x 1 in., x-ray	10
Suction tubing, 6 mm x 12 ft.	1
Syringe, asepto, 50 cc	1
Syringes, luer lock, 10 mL	2
Towels, cotton	6
Towels, low lint	4
Towels, non-absorbent with adhesive	4



Laminectomy I

Case Quantity: 3

Cat. No.
SPP99LM5AA

Contents	Quantity
<i>core components plus</i>	
Drape, loban, incise foil, 23 x 17 in.	1
Drapes, three-quarter, 52 x 76 in.	2
Gowns, Astound®, X-Large	2
Gown, Astound®, X-Large with towel	1
One-compartment tray, blue	1









Laminectomy II

Case Quantity: 2

Cat. No.
SPP99LM6AA

Contents	Quantity
<i>core components plus</i>	
Basin, emesis, 700 cc	1
Basins, ring, 5,500 cc	2
Cord, bipolar, 12 ft.	1
CSR wrap, 54 x 54 in.	1
Drape, laparotomy with armboards, 106 x 122 x 77 in.	1
Drape, loban, incise foil, 23 x 17 in.	1
Drapes, three-quarter, 52 x 76 in.	2
Gowns, Astound®, X-Large	2
Gown, Astound®, X-Large with towel	1
Pitcher, specimen, 1,200 cc	1
Sponge bowl, 48 oz.	1

 Basic drape fabric	 Reinforcements	 Side panel material
 Adhesive	 Incise	 Clear plastic panels and pouches

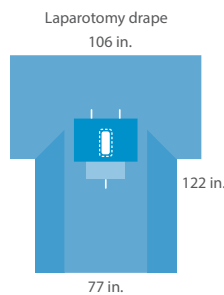

All products listed on this page are not made with natural rubber latex.

Standard Surgical Kits

Neurosurgery, Ophthalmic



Neurosurgery

Case Quantity: 2

Cat. No.	Contents	Quantity
SPP99NE5AA	<i>core components plus</i>	
	Basin, emesis, 700 cc	1
	Basins, ring, 5,500 cc	2
	Cord, bipolar, 12 ft.	1
	CSR wrap, 54 x 54 in.	1
	Drape, three-quarter, 52 x 76 in.	1
	Gowns, Astound®, fabric reinforced, X-Large	2
	Gown, Astound®, fabric reinforced, X-Large with towel	1
	Pitcher, specimen, 1,200 cc	1
	Sponge bowl, 48 oz.	1



Ophthalmic

Case Quantity: 8

Cat. No.	Contents	Quantity
SPP99EY2AA	Back table cover, 44 x 75 in.	1
	Bedside bag	1
	Cotton tip applicators, 3 in.	10
	Drape, ophthalmic, 48 x 51 in.	1
	Eye pad, oval	1
	Eye shield, clear plastic	1
	Eye spears	10
	Gauze, 4 x 4 in., 12-ply, non x-ray	10
	Gown, Astound®, X-Large	1
	Gown, Astound®, X-Large with towel	1
	Instrument wipe	1
	Labels, preprinted Ophthalmic, waterproof, 24/sheet	1
	Marker, utility	1
	Mayo stand cover, 23 in.	1
	Medicine cups, 2 oz.	2
	Needle counter, 10-20 count, foam block and adhesive	1
	Needle, 25G x 5/8 in.	1
	Sponge bowl, 32 oz.	1
	Syringe, bulb, 2 oz.	1
	Syringe, luer lock, 3 mL	1
	Syringe, slip-tip, 1 mL	1
	Towels, low lint	4

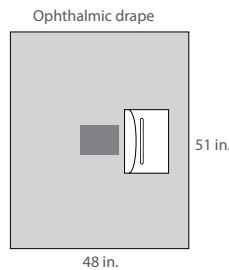

Basic drape fabric	Reinforcements	Side panel material
Adhesive	Incise	Clear plastic panels and pouches

All products listed on this page are not made with natural rubber latex.

Standard Surgical Kits

Orthopedics – Arthroscopy

Core components included in Arthroscopy and Arthroscopy Plus II kits

Contents	Quantity
Back table cover, 60 x 90 in., heavy-duty	1
Bandage, elastic, 6 in. x 5.8 yd.	1
Blade, #11, carbon steel	1
Drape, Poly U, with adhesive, 60 x 72 in.	1
Mayo stand cover, 23 in.	1
Stockinette, 12 x 48 in.	1
Suction tubing, 6 mm x 12 ft.	1
Towel, absorbent, white, 15½ x 22½ in.	1

Arthroscopy Pack

Case Quantity: 3

Cat. No.
28200-200

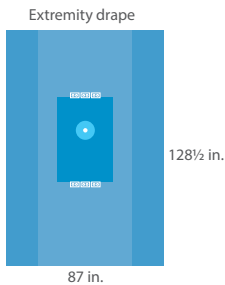

Contents	Quantity
<i>core components plus</i>	
Arthroscopy, specimen sock	1
Blade, #15, carbon steel	1
Drape, extremity, 87 x 128½ in.	1
Drape, half sheet, 40 x 57 in.	1
Gowns, Astound®, large	2
Gown, SmartGown™, X-Large, X-long, raglan sleeve	1
Mayo tray cover, 12¾ x 19 in.	1
One-compartment tray, 9 x 4¾ x 2 in.	1
Sponges, 4 x 4 in., 16-ply, x-ray	10
Towels, blue, cotton, 17 x 24 in.	3

Arthroscopy Pack with Bowls

Case Quantity: 2

Cat. No.
28200-100

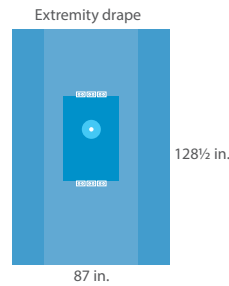

Contents	Quantity
<i>core components plus</i>	
Arthroscopy, specimen sock	1
Basins, emesis, 700 cc	2
Basins, ring, 5,500 cc	2
Blade, #15, carbon steel	1
Drape, extremity, 87 x 128½ in.	1
Drape, half sheet, 40 x 57 in.	1
Gowns, Astound®, large	2
Gown, SmartGown™, X-Large, X-long, raglan sleeve	1
Mayo tray cover, 12¾ x 19 in.	1
Medicine cups, 2 oz.	2
Sponge bowls, 32 oz.	2
Sponges, 4 x 4 in., 16-ply, x-ray	10
Towels, blue, cotton, 17 x 24 in.	3

Arthroscopy Pack with Fluid Control Drape

Case Quantity: 3

Cat. No.
28200-600

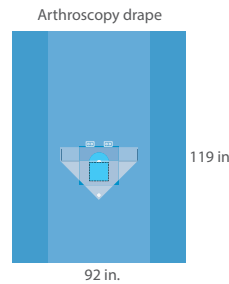

Contents	Quantity
<i>core components plus</i>	
Drape tapes, 4 x 18 in.	4
Drape, arthroscopy, fluid control pouch, 92 x 119 in.	1
Gown, Astound®, large	1
Gowns, SmartGown™, X-Large, X-long, raglan sleeve	2
Sponge bowl, 32 oz.	1
Towels, blue, cotton, 17 x 24 in.	8
Wrap, transfer, 23½ x 23½ in.	1

Arthroscopy Plus II Pack

Case Quantity: 3

Cat. No.
28200-500

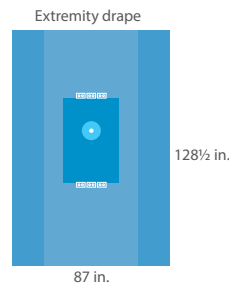

Contents	Quantity
<i>core components plus</i>	
Drape tapes, 4 x 18 in.	4
Drape, extremity, 87 x 128½ in.	1
Gown, Astound®, large	1
Gowns, SmartGown™, X-Large, X-long, raglan sleeve	2
Mayo tray cover, 12¾ x 19 in.	1
Sponge bowl, 32 oz.	1
Towels, blue, cotton, 17 x 24 in.	8
Wrap, transfer, 23½ x 23½ in.	1

Basic drape fabric	Reinforcements	Side panel material
Adhesive	Incise	Clear plastic panels and pouches

All products listed on this page are not made with natural rubber latex.

Standard Surgical Kits

Orthopedics – Arthroscopy Knee

Core components included in Knee Arthroscopy and Knee Arthroscopy Plus II kits

Contents	Quantity
Bandage, esmark, 6 in. x 12 ft.	1
Bandage, self-adherent, 4 in. x 5 yd.	1
Bedside bag	1
Blade, #11, carbon steel	1
Drape, three-quarter, 52 x 76 in.	1
Marker, skin, regular tip	1
Mayo stand cover, 23 in.	1
Needle, 18G x 1½ in.	1
Needle, spinal, 18G x 3½ in.	1
Ruler, 6 in., flexible	1
Sponges, 4 x 4 in., 16-ply, x-ray	10
Stockinette, 12 x 48 in.	1
Suction tubing, 6 mm x 12 ft.	1
Syringe, luer lock, 10 mL	1
Syringe, luer lock, 30 mL	1
Towels, blue, cotton, 17 x 24 in.	8

Knee Arthroscopy Pack

Case Quantity: 2

Cat. No.
SPP99KA3AA

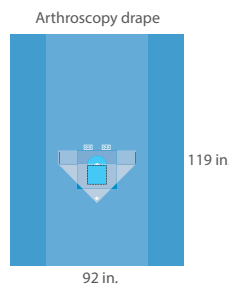

Contents	Quantity
<i>core components plus</i>	
Back table cover, 50 x 90 in.	1
Bandage, elastic, 6 in. x 5.8 yd.	1
Cast padding, 6 in. x 4 yd.	1
Drape, arthroscopy, with fluid control pouch, 92 x 119 in.	1
Drape, Poly U, with adhesive, 60 x 72 in.	1
Gowns, SmartGown™, X-Large	2
Labels, blank, ½ x 2 in., 3/strip	3
Label, dressing, 1 x 3 in.	1
Medicine cup, 2 oz.	1
Needle counter, 10-20 count, foam block, magnet	1
One-compartment tray, 9 x 4¾ x 2 in.	1
Sponge bowl, 32 oz.	1
Sponges, 4 x 4 in., 12-ply	10
Wrap, polyback 28 x 28 in.	1
Xeroform™ dressing, 1 x 8 in.	1
Zipper bags, 2 mil, 8 x 10 in.	3

Knee Arthroscopy Pack

Case Quantity: 3

Cat. No.
SPP99KA2AA

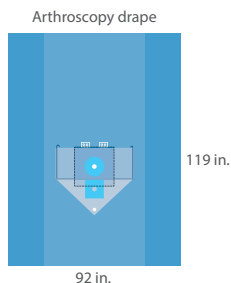

Contents	Quantity
<i>core components plus</i>	
Back table cover, 60 x 90 in., heavy-duty	1
Blade, #15, carbon steel	1
Drape, arthroscopy, with fluid control drawstring pouch, 92 x 119 in.	1
Drapes, Poly U, with adhesive, 60 x 72 in.	2
Gown, Astound®, X-Large with towel	1
Gowns, SmartGown™, X-Large, X-long, raglan sleeve	2
Labels, blank, ½ x 2 in., 3/strip	2
Medicine cups, 2 oz.	2
Needle counter, 20-40 count, foam block, magnet	1
One-compartment tray, 9 x 4¾ x 2 in.	1
Zipper bag, 2 mil, 8 x 10 in.	1

Knee Arthroscopy Plus II Pack

Case Quantity: 2

Cat. No.
SPP99KA1AA

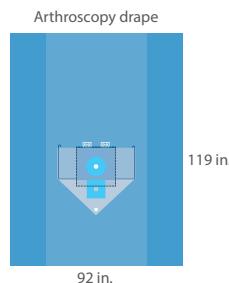

Contents	Quantity
<i>core components plus</i>	
Back table cover, 60 x 90 in., heavy-duty	1
Basin, emesis, 700 cc	1
Basin, ring, 5,500 cc	1
Blade, #15, carbon steel	1
CSR wrap, 54 x 54 in.	1
Drape, arthroscopy, with fluid control drawstring pouch, 92 x 119 in.	1
Drapes, Poly U, with adhesive, 60 x 72 in.	2
Gown, Astound®, X-Large with towel	1
Gowns, SmartGown™, X-Large, X-long, raglan sleeve	2
Labels, blank, ½ x 2 in., 3/strip	2
Medicine cups, 2 oz.	2
Needle counter, 20-40 count, foam block, magnet	1
Sponge bowl, 32 oz.	1
Sponge bowl, 48 oz.	1
Zipper bag, 2 mil, 6 x 8 in.	1

	Basic drape fabric		Reinforcements		Side panel material
	Adhesive		Incise		Clear plastic panels and pouches

All products listed on this page are not made with natural rubber latex.

Standard Surgical Kits

Orthopedics – Basic Ortho

Core components included in Basic Ortho and Basic Ortho Plus II kits

Contents	Quantity
Back table cover, 60 x 90 in., heavy-duty	1
Bedside bag	1
Blade, #10, carbon steel	1
Blade, #11, carbon steel	1
Blade, #15, carbon steel	1
Drape, Poly U, with adhesive, 60 x 72 in.	1
Drape, three-quarter, 56 x 77 in., reinforced	1
Gown, Astound®, fabric reinforced, X-Large	1
Gown, Astound®, X-Large with towel	1
Marker, skin, regular tip	1
Mayo stand cover, 23 in.	1
Medicine cups, 2 oz.	2
Needle counter, 20-40 count, foam block, magnet	1
Specimen container, 4½ oz., with screw lid	1
Sponges, 4 x 4 in., 16-ply, x-ray	10
Sponges, lap, 18 x 18 in.	5
Suction handle, bulbous tip, non-vented	1
Suction tubing, 6 mm x 12 ft.	1
Syringe, asepto, 50 cc	1
Towels, blue, cotton, 17 x 24 in.	8

Basic Ortho Pack

Case Quantity: 4

Cat. No.
SPP99OR2AA

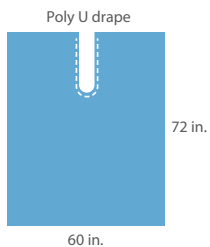

Contents	Quantity
<i>core components plus</i>	
Labels, blank, ½ x 2 in., 3/strip	2
One-compartment tray, 9 x 4¾ x 2 in.	1
Ruler, 6 in., flexible	1

Basic drape fabric	Reinforcements	Side panel material
Adhesive	Incise	Clear plastic panels and pouches

Basic Ortho Pack

Case Quantity: 4

Cat. No.
SPP99OR4AA

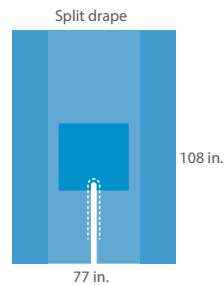

Contents	Quantity
<i>core components plus</i>	
Drape, split, 77 x 108 in.	1
One-compartment tray, 9 x 4¾ x 2 in.	1

Basic Ortho Plus II Pack

Case Quantity: 3

Cat. No.
SPP99OR1AA

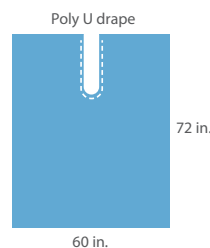

Contents	Quantity
<i>core components plus</i>	
Basin, emesis, 700 cc	1
Basin, ring, 5,500 cc	1
CSR wrap, 54 x 54 in.	1
Pitcher, 1200 cc	1
Sponge bowl, 48 oz.	1

Basic Ortho Plus II Pack

Case Quantity: 3

Cat. No.
SPP99OR3AA

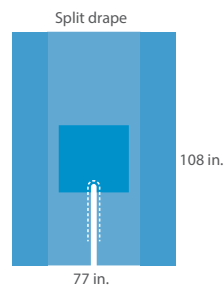

Contents	Quantity
<i>core components plus</i>	
Basin, emesis, 700 cc	1
Basin, ring, 5,500 cc	1
CSR wrap, 54 x 54 in.	1
Drape, split, 77 x 108 in.	1
Labels, blank, ½ x 2 in., 3/strip	2
Pitcher, 1200 cc	1
Ruler, 6 in., flexible	1
Sponge bowl, 48 oz.	1

All products listed on this page are not made with natural rubber latex.

Standard Surgical Kits

Orthopedics – Extremity-Hand

Hand Pack

Case Quantity: 3

Cat. No.

SPP99HD1AA

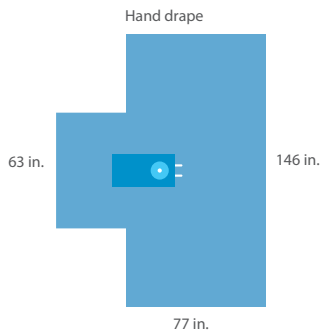

Contents	Quantity
Back table cover, 60 x 90 in., heavy-duty	1
Bandage, esmark, 4 in. x 9 ft.	1
Basin, emesis, 700 cc	1
Bedside bag	1
Blade, #15, carbon steel	1
Drape, hand, 77 x 146 in.	1
Drape, Poly U, with adhesive, 60 x 72 in.	1
Drape, three-quarter drape, 52 x 76 in.	1
Gown, Astound®, X-Large	1
Gown, Astound®, X-Large with towel	1
Labels, blank, ½ x 2 in., 3/strip	2
Marker, skin, regular tip	1
Mayo stand cover, 23 in.	1
Medicine cup, 2 oz.	1
Needle, 25G x 1½ in.	1
Needle counter, 10-20 count, foam block, magnet	1
Ruler, 6 in., flexible	1
Sponge bowl, 32 oz.	1
Sponges, 4 x 4 in., 16-ply, x-ray	10
Stockinette, 4 in. x 4 ft., 2-ply	1
Syringe, asepto, 50 cc	1
Syringe, luer lock, 10 mL	1
Towels, blue, cotton, 17 x 24 in.	6
Xeroform™ dressing, 1 x 8 in.	1
Zipper bag, 2 mil, 6 x 8 in.	1

Basic drape fabric	Reinforcements	Side panel material
Adhesive	Incise	Clear plastic panels and pouches

All products listed on this page are not made with natural rubber latex.

Standard Surgical Kits

Orthopedics – Extremity-Leg Fracture

Core components included in Leg Fracture and Leg Fracture Plus I, II and III kits

Contents	Quantity
Back table cover, 60 x 90 in., heavy-duty	1
Bandage, esmark, 4 in. x 9 ft.	1
Bandage, self-adherent, 4 in. x 5 yd.	1
Bedside bag	1
Blade, #10, carbon steel	1
Blade, #15, carbon steel	1
Drape, extremity, with armboard covers, 106 x 128½ x 87 in.	1
Drape, Poly U, with adhesive, 60 x 72 in.	1
Gauze dressing, 4½ in. x 4.1 yds., 6-ply	1
Gown, Astound®, fabric reinforced, X-Large	1
Gown, Astound®, X-Large with towel	1
Marker, skin, regular tip	1
Mayo stand cover, 23 in.	1
Medicine cups, 2 oz.	2
Needle counter, 10-20 count, double magnet	1
Sponges, 4 x 4 in., 16-ply, x-ray	10
Sponges, lap, 18 x 18 in.	10
Stockinette, 12 x 48 in.	1
Suction handle, bulbous tip, non-vented	1
Suction tubing, 6 mm x 12 ft.	1
Syringe, asepto, 50 cc	1
Towels, blue, cotton, 17 x 24 in.	10
Xeroform™ dressing, 1 x 8 in.	1
Zipper bag, 2 mil, 8 x 10 in.	1

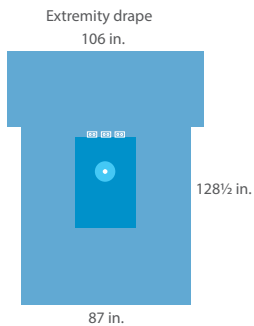

Basic drape fabric	Reinforcements	Side panel material
Adhesive	Incise	Clear plastic panels and pouches

All products listed on this page are not made with natural rubber latex.

Leg Fracture Pack

Case Quantity: 3

Cat. No.	Contents	Quantity
SPP99LE6AA	<i>core components</i> plus	
	One-compartment tray, 9 x 4¾ x 2 in.	1

Leg Fracture Plus I Pack

Case Quantity: 3

Cat. No.	Contents	Quantity
SPP99LE8AA	<i>core components</i> plus	
	Cautery pencil, rocker switch, with blade and holster	1
	Cautery tip cleaner	1
	Labels, blank, ½ x 2 in., 3/strip	2
	One-compartment tray, 9 x 4¾ x 2 in.	1
	Ruler, 6 in., flexible	1

Leg Fracture Plus II Pack

Case Quantity: 2

Cat. No.	Contents	Quantity
SPP99LE5AA	<i>core components</i> plus	
	Basin, emesis, 700 cc	1
	Basin, ring, 5,500 cc	1
	CSR wrap, 54 x 54 in.	1
	Sponge bowl, 32 oz.	1

Leg Fracture Plus III Pack

Case Quantity: 2

Cat. No.	Contents	Quantity
SPP99LE7AA	<i>core components</i> plus	
	Basin, emesis, 700 cc	1
	Basin, ring, 5,500 cc	1
	Cautery pencil, rocker switch, with blade and holster	1
	Cautery tip cleaner	1
	CSR wrap, 54 x 54 in.	1
	Glassine, bag, 23/4 x 41/4 in.	1
	Sponge bowl, 32 oz.	1

Standard Surgical Kits

Orthopedics – Extremity-Major

Core components included in Major Extremity Plus I and Major Extremity Setup kits

Contents	Quantity
Back table cover, 60 x 90 in., heavy-duty	1
Bedside bag	1
Drape, extremity, 87 x 128½ in.	1
Mayo stand cover, 23 in.	1
Suction tubing, 6 mm x 12 ft.	1
Syringe, asepto, 50 cc	1

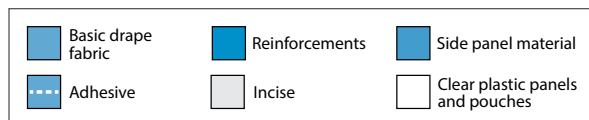
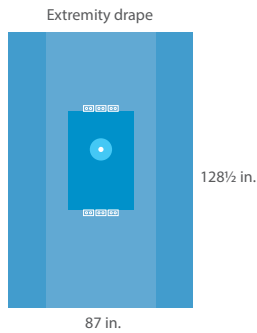

All products listed on this page are not made with natural rubber latex.

Major Extremity Plus I Pack

Case Quantity: 4

Cat. No.	Contents	Quantity
SPP99EX3AA	<i>core components plus</i>	
	Bandage, elastic, 4 in. x 5.8 yd.	1
	Bandage, esmark, 4 in. x 9 ft.	1
	Basin, emesis, 700 cc	1
	Blade, #10, carbon steel	1
	Blade, #15, carbon steel	2
	Cautery pencil, push-button, with blade and holster	1
	Drape, Poly U, with adhesive, 60 x 72 in.	1
	Drape, three-quarter, 52 x 76 in.	1
	Electrode blade, 2¾ in., coated	1
	Gown, Astound®, fabric reinforced, X-Large	1
	Gown, Astound®, X-Large with towel	1
	Labels, blank, ½ x 2 in., 3/strip	3
	Label, dressing, 1 x 3 in., waterproof	1
	Light handle covers, flexible, green	2
	Marker, skin, regular tip	1
	Medicine cup, 2 oz.	1
	Needle counter, 10-20 count, foam block, magnet	1
	Needle, 22G x 1½ in.	1
	Ruler, 6 in., flexible	1
	Sponges, 4 x 4 in., 12-ply	10
	Sponges, 4 x 4 in., 16-ply, x-ray	10
	Stockinette, 12 x 48 in.	1
	Syringe, luer lock, 10 mL	1
	Towels, blue, cotton, 17 x 24 in.	7
	Sponge bowl, 32 oz.	1
	Zipper bags, 2 mil, 6 x 8 in.	2

Major Extremity Setup Pack

Case Quantity: 2

Cat. No.	Contents	Quantity
28200-300	<i>core components plus</i>	
	Blades, #10, carbon steel	2
	Blade, #15, carbon steel	1
	Blade, #20, carbon steel	1
	Cautery tip cleaner	1
	CSR wrap, 23½ x 23½ in.	1
	Drape, Poly U, with adhesive, 60 x 84 in.	1
	Gown, Astound®, large	1
	Gowns, SmartSleeve™, X-Large	2
	Sponges, 4 x 4 in., 12-ply, x-ray	10
	Sponges, lap, 18 x 18 in.	15
	Towels, blue, cotton, 17 x 24 in.	10
	Towels, non-absorbent, with adhesive 17 x 26 in.	4

Standard Surgical Kits

Orthopedics – Extremity-Upper

Core components included in Upper Extremity and Upper Extremity Plus II kits

Contents	Quantity
Back table cover, 60 x 90 in., heavy-duty	1
Bedside bag	1
Blades, #15, carbon steel	2
Drape, extremity, 87 x 128½ in.	1
Drape, three-quarter, 57 x 76 in.	1
Gown, Astound®, X-Large	1
Gown, Astound®, X-Large with towel	1
Labels, blank, ½ x 2 in., 3/strip	2
Marker, skin, regular tip	1
Mayo stand cover, 23 in.	1
Medicine cup, 2 oz.	1
Needle counter, 10-20 count, foam block, magnet	1
Needle, 25G x 1½ in.	1
Ruler, 6 in., flexible	1
Sponges, 4 x 4 in., 16-ply, x-ray	10
Sponges, lap, 18 x 18 in.	5
Stockinette, 12 x 48 in.	1
Suction tubing, 6 mm x 12 ft.	1
Syringe, luer lock, 10 mL	1
Syringe, asepto, 50 cc	1
Towels, blue, cotton, 17 x 24 in.	6
Xeroform™ dressing, 1 x 8 in.	1

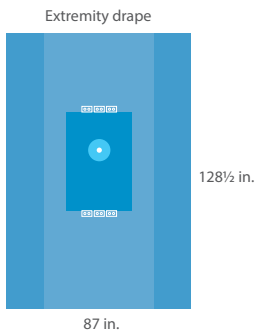

All products listed on this page are not made with natural rubber latex.

Upper Extremity Pack

Case Quantity: 4

Cat. No.	Contents	Quantity
SPP99EX2AA	<i>core components</i> plus	
	One-compartment tray, 9 x 4¾ x 2 in.	1

Upper Extremity Plus II Pack

Case Quantity: 3

Cat. No.	Contents	Quantity
SPP99EX1AA	<i>core components</i> plus	
	Basin, emesis, 700 cc	1
	Basin, ring, 5,500 cc	1
	CSR wrap, 54 x 54 in.	1
	Sponge bowl, 32 oz.	1

Standard Surgical Kits

Orthopedics – Hip Fracture, Hip Setup

Core components included in Hip Fracture, Hip Fracture Plus I, II, III and Hip Setup kits

Contents	Quantity
Back table cover, 60 x 90 in., heavy-duty	1
Bedside bag	1
Blade, #10, carbon steel	1
Blade, #20, carbon steel	1
Gown, Astound®, fabric reinforced, X-Large	1
Gown, SmartSleeve™, X-Large	1
Mayo stand cover, 23 in.	1
Marker, skin, with ruler and labels	1
Medicine cups, 2 oz.	2
Needle counter, 20-40 count, foam block, magnet	1
Sponges, 4 x 4 in., 16-ply, x-ray	10
Sponges, lap, 18 x 18 in.	15
Suction handle, bulbous tip, non-vented	1
Suction tubing, 7 mm x 12 ft.	1
Syringe, asepto, 50 cc	1
Towels, blue, cotton, 17 x 24 in.	12

Hip Fracture Pack







Case Quantity: 4

Cat. No.	Contents	Quantity
SPP99HF4AA	core components plus	
	One-compartment tray, 9 x 4¾ x 2 in.	1

Hip Fracture Plus I Pack

Case Quantity: 3

Cat. No.	Contents	Quantity
SPP99HF2AA	core components plus	
	Cautery pencil, rocker switch, with blade and holster	1
	Cautery tip cleaner	1
	Foam tray, 14 x 18 in.	1
	Glassine, bag, 2¾ x 4¼ in.	1
	One-compartment tray, 9 x 4¾ x 2 in.	1

	Basic drape fabric		Reinforcements		Side panel material
	Adhesive		Incise		Clear plastic panels and pouches

All products listed on this page are not made with natural rubber latex.

Hip Fracture Plus II Pack

Case Quantity: 2

Cat. No.	Contents	Quantity
SPP99HF3AA	core components plus	
	Basin, emesis, 700 cc	1
	Basins, ring 5,500 cc	2
	CSR wrap, 54 x 54 in.	1
	Pitcher, 1200 cc	1
	Sponge bowls, 32 oz.	2

Hip Fracture Plus III Pack

Case Quantity: 2

Cat. No.	Contents	Quantity
SPP99HF1AA	core components plus	
	Basin, emesis, 700 cc	1
	Basins, ring 5,500 cc	2
	Cautery pencil, rocker switch, with blade and holster	1
	Cautery tip cleaner	1
	CSR wrap, 54 x 54 in.	1
	Pitcher, 1200 cc	1
	Sponge bowls, 32 oz.	2

Hip Setup Pack

Case Quantity: 2

Cat. No.	Contents	Quantity
28200-400	core components plus	
	Blade, #15, carbon steel	1
	Cautery tip cleaner	1
	CSR wrap, 23½ x 23½ in.	1
	Drape, Poly U, with adhesive, 60 x 84 in.	1
	Drape, split, 77 x 100 in.	1
	Drape, top sheet, 53 x 99 in.	1
	Gown, Astound®, large	1
	Gown, Astound®, poly-reinforced, X-Large	1
	Mayo tray, 12¾ x 19 in.	1
	One-compartment tray, 5½ x 4½ x 2 in.	1
	Stockinette, 12 x 48 in.	1
	Suction handle, bulbous tip, non-vented	1
	Suction tubing, 6 mm x 12 ft.	1
	Towels, non-absorbent with adhesive	4
	Wrap, transfer, 23½ x 23½ in.	1

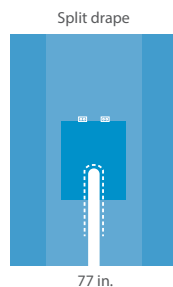

Standard Surgical Kits

Orthopedics – Total Hip

Core components included in Total Hip and Total Hip Plus II and III kits

Contents	Quantity
Back table covers, 60 x 90 in., heavy-duty	2
Bandage, self-adherent, 4 in. x 5 yd.	1
Bedside bag	1
Blades, #10, carbon steel	2
Blade, #15, carbon steel	1
Blades, #20, carbon steel	2
Drape, hip, with pouch and armboard covers, 115 x 134 in.	1
Drapes, Poly U, with adhesive, 60 x 72 in.	2
Drape, three-quarter, 56 x 77 in., reinforced	1
Gowns, SmartSleeve™, X-Large, reinforced	2
Gown, SmartSleeve™, X-Large with towel	1
Labels, blank, ½ x 2 in., 3/strip	2
Marker, skin, regular tip	1
Mayo stand cover, 23 in.	1
Medicine cups, 2 oz.	2
Needle counter, 20-40 count, foam block, magnet	1
Ruler, 6 in., flexible	1
Sponges, 4 x 4 in., 16-ply, x-ray	10
Sponges, lap, 18 x 18 in.	10
Stockinette, 12 x 48 in.	1
Suction handle, bulbous tip, non-vented	1
Suction tubing, 6 mm x 12 ft.	1
Syringe, asepto, 50 cc	1
Towels, blue, cotton, 17 x 24 in.	16
Towels, non-absorbent with adhesive	4

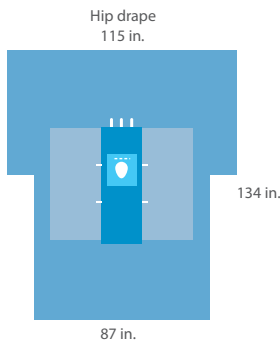

All products listed on this page are not made with natural rubber latex.

Total Hip Pack

Case Quantity: 3

Cat. No.	Contents	Quantity
SPP99TH2AA	<i>core components</i> plus	
	One-compartment tray, 9 x 4¾ x 2 in.	1

Total Hip Plus II Pack

Case Quantity: 3

Cat. No.	Contents	Quantity
SPP99TH4AA	<i>core components</i> plus	
	Cautery pencil, rocker switch, with blade and holster	1
	Cautery tip cleaner	1
	One-compartment tray, 9 x 4¾ x 2 in.	1

Total Hip Plus II Pack

Case Quantity: 2

Cat. No.	Contents	Quantity
SPP99TH1AA	<i>core components</i> plus	
	Basin, emesis, 700 cc	1
	Basins, ring 5,500 cc	2
	CSR wrap, 30 x 30 in.	1
	CSR wrap, 54 x 54 in.	1
	Pitcher, 1200 cc	1
	Sponge bowl, 32 oz.	1
	Sponge bowl, 48 oz.	1

Total Hip Plus III Pack

Case Quantity: 2

Cat. No.	Contents	Quantity
SPP99TH3AA	<i>core components</i> plus	
	Basin, emesis, 700 cc	1
	Basins, ring 5,500 cc	2
	Cautery pencil, rocker switch, with blade and holster	1
	Cautery tip cleaner	1
	CSR wrap, 54 x 54 in.	1
	Pitcher, 1200 cc	1
	Sponge bowl, 32 oz.	1
	Sponge bowl, 48 oz.	1

Standard Surgical Kits

Orthopedics – Knee and Ankle

Core components included in Knee and Ankle and Knee and Ankle Plus I, II and III kits

Contents	Quantity
Back table cover, 60 x 90 in., heavy-duty	1
Bandage, esmark, 4 in. x 9 ft.	1
Bandage, self-adherent, 4 in. x 5 yd.	1
Bedside bag	1
Blade, #10, carbon steel	1
Blade, #15, carbon steel	1
Drape, extremity, with armboard covers, 106 x 128½ x 87 in.	1
Drape, Poly U, with adhesive, 60 x 72 in.	1
Drape, three-quarter, 52 x 76 in.	1
Gauze dressing, 4½ in. x 4.1 yd., 6-ply	1
Gown, Astound®, fabric reinforced, X-Large	1
Gown, Astound®, X-Large with towel	1
Mayo stand cover, 23 in.	1
Medicine cups, 2 oz.	2
Needle counter, 10-20 count, double magnet	1
Sponges, 4 x 4 in., 16-ply, x-ray	10
Sponges, lap, 18 x 18 in.	5
Stockinette, 12 x 48 in.	1
Suction handle, bulbous tip, non-vented	1
Suction tubing, 6 mm x 12 ft.	1
Syringe, asepto, 50 cc	1
Towels, blue, cotton, 17 x 24 in.	10
Xeroform™ dressing, 1 x 8 in.	1
Zipper bag, 2 mil, 6 x 8 in.	1

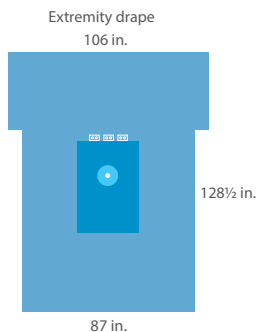

Basic drape fabric	Reinforcements	Side panel material
Adhesive	Incise	Clear plastic panels and pouches

All products listed on this page are not made with natural rubber latex.

Knee and Ankle Pack

Case Quantity: 3

Cat. No.	Contents	Quantity
SPP99LE2AA	<i>core components plus</i>	
	Labels, blank, ½ x 2 in., 3/strip	2
	Marker, skin, regular tip	1
	One-compartment tray, 9 x 4¾ x 2 in.	1
	Ruler, 6 in., flexible	1

Knee and Ankle Plus I Pack

Case Quantity: 3

Cat. No.	Contents	Quantity
SPP99LE4AA	<i>core components plus</i>	
	Cautery pencil, rocker switch, with blade and holster	1
	Cautery tip cleaner	1
	Glassine, bag, 2¾ x 4¼ in.	1
	Marker, skin, with ruler and labels	1
	One-compartment tray, 9 x 4¾ x 2 in.	1

Knee and Ankle Plus II Pack

Case Quantity: 2

Cat. No.	Contents	Quantity
SPP99LE1AA	<i>core components plus</i>	
	Basin, emesis, 700 cc	1
	Basin, ring, 5,500 cc	1
	CSR wrap, 54 x 54 in.	1
	Labels, blank, ½ x 2 in., 3/strip	2
	Marker, skin, regular tip	1
	Ruler, 6 in., flexible	1
	Sponge bowl, 32 oz.	1

Knee and Ankle Plus III Pack

Case Quantity: 2

Cat. No.	Contents	Quantity
SPP99LE3AA	<i>core components plus</i>	
	Basin, emesis, 700 cc	1
	Basin, ring, 5,500 cc	1
	Cautery pencil, rocker switch, with blade and holster	1
	Cautery tip cleaner	1
	CSR wrap, 54 x 54 in.	1
	Glassine, bag, 2¾ x 4¼ in.	1
	Marker, skin, with ruler and labels	1
	Sponge bowl, 32 oz.	1

Standard Surgical Kits

Orthopedics – Total Knee

Core components included in Total Knee and Total Knee Plus I, II and III kits

Contents	Quantity
Back table cover, 60 x 90 in., heavy-duty	1
Bandage, esmark, 6 in. x 12 ft.	1
Bandage, self-adherent, 4 in. x 5 yd.	1
Bedside bag	1
Blades, #10, carbon steel	2
Blade, #15, carbon steel	1
Blades, #20, carbon steel	2
Drape, extremity, with armboard covers, 106 x 128½ x 87 in.	1
Drape, Poly U, with adhesive, 60 x 72 in.	1
Drape, three-quarter, 52 x 76 in.	1
Gowns, SmartSleeve™, X-Large, reinforced	2
Gown, SmartSleeve™, X-Large with towel	1
Labels, blank, ½ x 2 in., 3/strip	2
Marker, skin, regular tip	1
Mayo stand cover, 23 in.	1
Medicine cups, 2 oz.	2
Needle counter, 20-40 count, foam block, magnet	1
Ruler, 6 in., flexible	1
Sponges, 4 x 4 in., 16-ply, x-ray	10
Sponges, lap, 18 x 18 in.	15
Stockinette, 12 x 48 in.	1
Suction handle, bulbous tip, non-vented	1
Suction tubing, 6 mm x 12 ft.	1
Syringe, asepto, 50 cc	1
Towels, blue, cotton, 17 x 24 in.	16

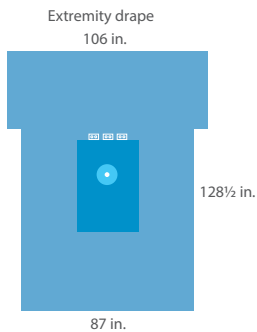

Basic drape fabric	Reinforcements	Side panel material
Adhesive	Incise	Clear plastic panels and pouches

All products listed on this page are not made with natural rubber latex.

Total Knee Pack

Case Quantity: 3

Cat. No.	Contents	Quantity
SPP99TN4AA	<i>core components</i> plus	
	One-compartment tray, 9 x 4¾ x 2 in.	1
	Zipper bag, 2 mil, 6 x 8 in.	1

Total Knee Plus I Pack

Case Quantity: 3

Cat. No.	Contents	Quantity
SPP99TN2AA	<i>core components</i> plus	
	Cautery pencil, rocker switch, with blade and holster	1
	Cautery tip cleaner	1
	One-compartment tray, 9 x 4¾ x 2 in.	1
	Sponge bowl, 32 oz.	1
	Zipper bag, 2 mil, 8 x 10 in.	1

Total Knee Plus II Pack

Case Quantity: 2

Cat. No.	Contents	Quantity
SPP99TN3AA	<i>core components</i> plus	
	Basin, emesis, 700 cc	1
	Basins, ring 5,500 cc	2
	CSR wrap, 54 x 54 in.	1
	Pitcher, 1200 cc	1
	Sponge bowl, 32 oz.	1
	Sponge bowl, 48 oz.	1
	Zipper bag, 2 mil, 8 x 10 in.	1

Total Knee Plus III Pack

Case Quantity: 2

Cat. No.	Contents	Quantity
SPP99TN1AA	<i>core components</i> plus	
	Basin, emesis, 700 cc	1
	Basins, ring 5,500 cc	2
	Cautery pencil, rocker switch, with blade and holster	1
	Cautery tip cleaner	1
	CSR wrap, 54 x 54 in.	1
	Pitcher, 1200 cc	1
	Sponge bowl, 32 oz.	1
	Sponge bowl, 48 oz.	1
	Zipper bag, 2 mil, 8 x 10 in.	1

Standard Surgical Kits

Orthopedics – Shoulder

Core components included in Shoulder Arthroscopy, Shoulder Beach Chair and Plus II kits

Contents	Quantity
Back table cover, 60 x 90 in., heavy-duty	1
Bandage, self-adherent, 4 in. x 5 yd.	1
Bedside bag	1
Blade, #11, carbon steel	1
Blade, #15, carbon steel	1
Drape, Poly U, with adhesive, 60 x 72 in.	1
Drape, three-quarter, 52 x 76 in.	1
Gowns, SmartGown™, X-Large, X-long, raglan sleeve	2
Gown, Astound®, X-Large with towel	1
Labels, blank, ½ x 2 in., 3/strip	2
Marker, skin, regular tip	1
Mayo stand cover, 23 in.	1
Medicine cups, 2 oz.	2
Needle counter, 20-40 count, foam block, magnet	1
Needle, 18G x 1½ in.	1
Needle, spinal, 18G x 3½ in.	1
Ruler, 6 in., flexible	1
Sponges, 4 x 4 in., 16-ply, x-ray	10
Stockinette, 9 x 48 in.	1
Suction tubing, 6 mm x 12 ft.	1
Syringe, luer lock, 10 mL	1
Syringe, luer lock, 30 mL	1
Towels, blue, cotton, 17 x 24 in.	8

Shoulder Arthroscopy Pack

Case Quantity: 3

Cat. No.
SPP99SA2AA

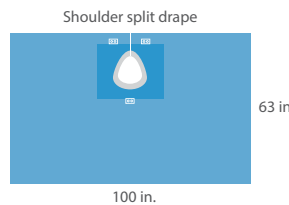

Contents	Quantity
<i>core components plus</i>	
Drape, shoulder split, 77 x 116 in.	1
Drape, shoulder split, 100 x 63 in.	1
One-compartment tray, 9 x 4¾ x 2 in.	1

Shoulder Arthroscopy Plus II Pack

Case Quantity: 2

Cat. No.
SPP99SA1AA

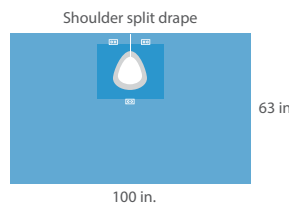

Contents	Quantity
<i>core components plus</i>	
Basin, emesis, 700 cc	1
Basin, ring, 5,500 cc	1
CSR wrap, 54 x 54 in.	1
Drape, shoulder split, 77 x 116 in.	1
Drape, shoulder split, 100 x 63 in.	1
Sponge bowl, 32 oz.	1
Sponge bowl, 48 oz.	1

Shoulder Beach Chair Pack

Case Quantity: 3

Cat. No.
SPP99SB2AA

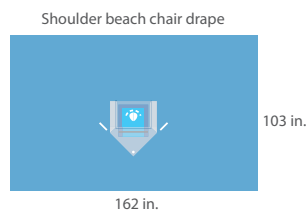

Contents	Quantity
<i>core components plus</i>	
Drape, shoulder, beach chair with pouch, 162 x 103 in.	1
One-compartment tray, 9 x 4¾ x 2 in.	1

Shoulder Beach Chair Plus II Pack

Case Quantity: 2

Cat. No.
SPP99SB1AA



Contents	Quantity
<i>core components plus</i>	
Basin, emesis, 700 cc	1
Basin, ring, 5,500 cc	1
CSR wrap, 54 x 54 in.	1
Drape, shoulder, beach chair with pouch, 162 x 103 in.	1
Sponge bowl, 32 oz.	1
Sponge bowl, 48 oz.	1

Basic drape fabric	Reinforcements	Side panel material
Adhesive	Incise	Clear plastic panels and pouches

All products listed on this page are not made with natural rubber latex.

Standard Surgical Kits

Plastics – Facial, Oculoplastic

Core components included in Facial, Oculoplastic kits

Contents	Quantity
Basin, emesis, 700 cc	1
Bedside bag	1
Blade, #15, carbon steel	1
Cotton tip applicators, 6 in.	6
Drape, head/bar, 42 x 34 in.	1
Drape, split sheet, 77 x 110 in.	1
Gown, Astound®, X-Large	1
Gown, Astound®, X-Large with towel	1
Instrument pouch	1
Marker, dual-tip	1
Mayo stand cover, 23 in.	1
Medicine cups, 2 oz.	2
Needle counter, 20-40 count, foam block, magnet	1
Needle, 25G x 1½ in.	1
Needle, precision glide, 27G x 1¼ in.	1
Ruler, 6 in., flexible	1
Sponge bowl, 32 oz.	1
Syringe, control, luer lock, 10 mL	1
Syringe, luer lock, 10 mL	1
Towels, cotton	2
Towels, low lint	4

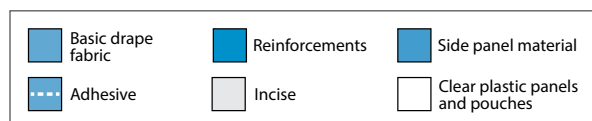

Facial

Case Quantity: 2

Cat. No.
SPP99FP3AA

Head/bar drape

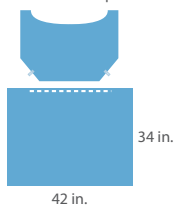

Split sheet drape

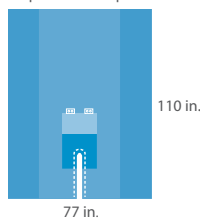

Contents	Quantity
<i>core components plus</i>	
Back table cover, 60 x 90 in.	1
Basin, ring, 5,500 cc	1
Blade, #15, carbon steel	1
CSR wrap, 54 x 54 in.	1
Gauze, 4 x 4 in., 16-ply, x-ray	10
Gown, Astound®, X-Large	1
Labels, preprinted Plastic Surgery, waterproof, 32/sheet	1
Sponges, lap, 18 x 18 in., x-ray	5
Suction tubing, 6 mm x 12 ft.	1
Syringe, asepto, 50 cc	1
Towels, cotton	4



Oculoplastic

Case Quantity: 2

Cat. No.
SPP99OC1AA

Head/bar drape

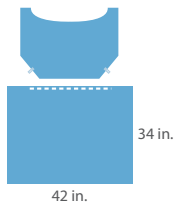

Split sheet drape

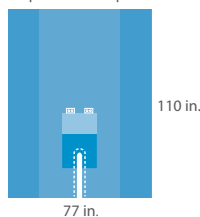

Contents	Quantity
<i>core components plus</i>	
Back table cover, 50 x 90 in.	1
Cotton tip applicators, 3 in.	10
Cotton tip applicators, 6 in.	4
Eye spears	10
Gauze, 4 x 4 in., 16-ply, non x-ray	10
Instrument wipe	1
Labels, preprinted Ophthalmic, waterproof, 24/sheet	1
Needle, 30G x 1 in.	1
One-compartment tray, blue	1
Sponge bowl, 16 oz.	1
Syringe, bulb, 2 oz.	1

All products listed on this page are not made with natural rubber latex.

Standard Surgical Kits

Podiatry I, Podiatry II

Core components included in Podiatry I, Podiatry II kits

Contents	Quantity
Back table cover, 50 x 90 in.	1
Bandage, esmark, 4 in. x 9 ft.	1
Bandage, self-adherent, 4 in. x 5 yd.	1
Bedside bag	1
Blades, #15, carbon steel	2
Drape, extremity, 87 x 128½ in.	1
Drape, three-quarter, 52 x 76 in.	1
Gauze, 4 x 4 in., 12-ply, non x-ray	10
Gauze, 4 x 4 in., 16-ply, x-ray	10
Gown, Astound®, X-Large	1
Gown, Astound®, X-Large with towel	1
Labels, preprinted OR, waterproof, 30/sheet	1
Marker, dual-tip	1
Mayo stand cover, 23 in.	1
Medicine cups, 2 oz.	2
Needle counter, 10-20 count, foam block, magnet	1
Needle, 18G x 1½ in.	1
Needle, 25G x 1½ in.	1
Ruler, 6 in., flexible	1
Sponges, lap, 18 x 18 in., x-ray	5
Stockinette, 12 x 48 in.	1
Suction tubing, 6 mm x 12 ft.	1
Syringe, asepto, 50 cc	1
Syringe, luer lock, 10 mL	1
Towels, cotton	4
Towels, low lint	2



Podiatry I

Case Quantity: 4

Cat. No.
SPP99PD3AA

Contents	Quantity
<i>Includes core components</i>	

Extremity drape

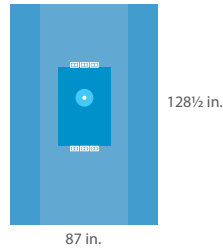

Podiatry II

Case Quantity: 3

Cat. No.
SPP99PD4AA

Contents	Quantity
<i>core components plus</i>	

Extremity drape

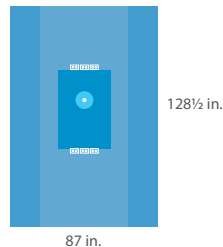

Basin, emesis, 700 cc	1
Basin, ring, 5,500 cc	1
CSR wrap, 54 x 54 in.	1
Dressing, non-adherent, oil emulsion, 3 x 3 in.	1
Gauze, 6 x 6¾ in., 12-ply, non x-ray	5
Sponge bowls, 32 oz.	2

Basic drape fabric	Reinforcements	Side panel material
Adhesive	Incise	Clear plastic panels and pouches







All products listed on this page are not made with natural rubber latex.

Standard Surgical Kits

Urology – Cysto, TUR I, TUR II

Core components included in Cysto, TUR I, TUR II kits

Contents	Quantity
Back table cover, 50 x 90 in.	1
Bedside bag	1
Drape, Cysto-T, 64 x 91½ in.	1
Gauze, 4 x 4 in., 16-ply, x-ray	10
Gown, SmartGown™, X-Large, X-long, raglan sleeve	1
Labels, blank, ½ x 2 in., 3/strip	3
Leggings, 31 x 48 in., 6 in. cuff	2
Lubricating jelly, 2 oz.	1
Marker, skin	1
Medicine cups, 2 oz.	2
Ruler, 6 in., flexible	1
Specimen container, 4½ oz., with screw lid	1
Towel, absorbent	1
Towels, cotton	4

 Basic drape fabric	 Reinforcements	 Side panel material
 Adhesive	 Incise	 Clear plastic panels and pouches

All products listed on this page are not made with natural rubber latex.



TUR I

Case Quantity: 6

Cat. No.
SPP99TU2AA

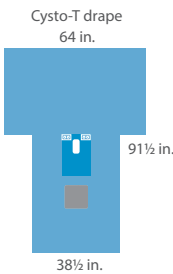

Contents	Quantity
<i>core components plus</i>	
Irrigation set, TUR	1
One-compartment tray, white	1
Syringe, luer lock, 20 mL	1



Cysto

Case Quantity: 6

Cat. No.
SPP99CY1AA

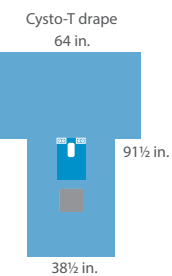

Contents	Quantity
<i>core components plus</i>	
Basin, emesis, 700 cc	1
Irrigation set, bladder	1
Sponge bowl, 32 oz.	1
Syringe, luer lock, 10 mL	1



TUR II

Case Quantity: 3

Cat. No.
SPP99TU1AA

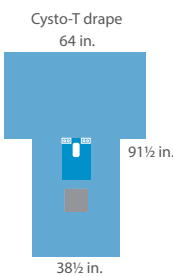

Contents	Quantity
<i>core components plus</i>	
Basin, emesis, 700 cc	1
Basin, ring, 5,500 cc	1
CSR wrap, 54 x 54 in.	1
Irrigation set, TUR	1
Sponge bowl, 32 oz.	1
Syringe, luer lock, 20 mL	1

Standard Surgical Kits

Women's Health – Breast

Breast - General Biopsy

Case Quantity: 10

Cat. No.	Contents	Quantity
NI12-0349	Ampule tray	1
	CSR, 24 x 24 in.	1
	Gauze, 4 x 4 in., 12-ply	10
	Lidocaine, 1%, glass ampule, 10 mL	1
	Needle, 25G x 1½ in.	1
	One-compartment tray	1
	PVP-I swabstick, 3/pk	1
	Syringe, luer lock, 5 mL	1
	Tape strip, 3 per card, ½ x 4 in.	1



Breast - General Plastic

Case Quantity: 2





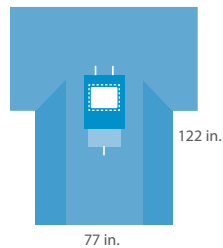

Cat. No.

SPP99BST1A

Chest/breast drape
106 in.



Contents	Quantity
Back table cover, 60 x 90 in.	1
Basin, emesis, 700 cc	1
Basin, ring, 7 qt.	1
Bedside bag	1
Blades, #10, carbon steel	2
Blade, #15, carbon steel	1
CSR wrap, 54 x 54 in.	1
Drape, chest/breast with armboards, 106 x 122 x 77 in.	1
Gauze, 4 x 4 in., 16-ply, x-ray	10
Gown, Astound®, X-Large	1
Gown, Astound®, X-Large with towel	1
Labels, preprinted OR, waterproof, 30/sheet	1
Marker, dual-tip	1
Mayo stand cover, 23 in.	1
Medicine cups, 2 oz.	2
Needle counter, 40-70 count, foam block, magnet	1
Needle, 22G x 1½ in.	1
Needle, 25G x 1½ in.	1
Pitcher, specimen, 1,200 cc	1
Ruler, 6 in., flexible	1
Specimen container, 4½ in., with screw lid	1
Sponge bowl, 32 oz.	1
Sponges, lap, 18 x 18 in.	10
Suction tubing, 6 mm x 12 ft.	1
Syringe, asepto, 50 cc	1
Syringe, luer lock, 10 mL	1
Towels, cotton	4
Towels, low lint	4
Towels, non-absorbent with adhesive	4
Yankauer suction handle, bulbous tip, non-vented	1

 Basic drape fabric	 Reinforcements	 Side panel material
 Adhesive	 Incise	 Clear plastic panels and pouches

All products listed on this page are not made with natural rubber latex.

Standard Surgical Kits

Women's Health – Circumcision



Circumcision Tray







Case Quantity: 20

Cat. No.	Contents	Quantity
02-1400	CSR wrap	1
	Drape, 5/8 in. fenestration, 11 1/2 x 20 in.	1
	Gauze, 4 x 4 in., 8-ply	10
	Instrument, forceps, Halstead Mosquito, 5 in., curved	2
	Instrument, forceps, Halstead Mosquito, 5 in., straight	1
	Instrument, probe, 5 1/2 in., with eye	1
	Instrument, scissors, Iris, 4 1/2 in., straight, sharp	1
	Instrument, scissors, operating, 4 1/2 in., straight, sharp/blunt	1
	Medicine cup, 2 oz.	1
	Petrolatum dressing, 1 x 8 in., cision	1
	PVP-I swabsticks, 3/pack	1
	Safety pins	2
	Scalpel, safety, #10	1
	Two-compartment tray	1

Circumcision Tray

Case Quantity: 20

Cat. No.	Contents	Quantity
02-4078	CSR wrap	1
	Drape, 5/8 in. fenestration, 11 1/2 x 20 in.	1
	Gauze, 4 x 4 in., 8-ply	10
	Instrument, forceps, Halstead Mosquito, 5 in., curved	2
	Instrument, forceps, Halstead Mosquito, 5 in., straight	1
	Instrument, probe, 5 1/2 in., with eye	1
	Instrument, scissors, Iris, 4 1/2 in., straight, sharp	1
	Instrument, scissors, operating, 4 1/2 in., straight, sharp/blunt	1
	Medicine cup, 2 oz.	1
	Petrolatum dressing, 1 x 8 in., Xeroform	1
	PVP-I swabsticks, 3/pack	1
	Safety pins	2
	Scalpel, #10	1
	Two-compartment tray	1

	Basic drape fabric		Reinforcements		Side panel material
	Adhesive		Incise		Clear plastic panels and pouches

All products listed on this page are not made with natural rubber latex.

Standard Surgical Kits







Women's Health – Gynecology D & C

D & C

Case Quantity: 4

Cat. No.	Contents	Quantity
SPP99GY3AA	Back table cover, 50 x 90 in.	1
	Bag, 7 x 10 in.	1
	Catheter, 14FR, tapered end	1
	Drape, lithotomy, fenestrated	1
	Drape, under buttocks with fluid control pouch, 38 x 48 in.	1
	Dressing, non-adherent double sided, 3 x 8 in.	1
	Gauze, 4 x 4 in., 16-ply, x-ray	10
	Gown, Astound®, X-Large	1
	Labels, sheet of 3, 1/2 x 2 in.	3
	Lubricating jelly, 5gm	2
	Marker, regular tip, violet	1
	OB pad with wings, adhesive	1
	Ruler, 6 in., flexible	1
	Specimen containers, 4 1/2 in., with screw lid	2
	Surgical leggings with cuff, 31 x 48 in.	2
	Towels, cotton	5
	Wet skin scrub prep kit	1



 Basic drape fabric	 Reinforcements	 Side panel material
 Adhesive	 Incise	 Clear plastic panels and pouches

All products listed on this page are not made with natural rubber latex.

Standard Surgical Kits

Women's Health – Gynecology General

Core components included in General Gynecology kits

Contents	Quantity
Back table cover, 50 x 90 in.	1
Bedside bag	1
Drape, lithotomy, fluid control pouch, 63 x 118 in.	1
Drape, under buttocks with cuff, 36 x 49 in.	1
Dressing, non-adherent double sided, 3 x 8 in.	1
Gauze, 4 x 4 in., 16-ply, x-ray	10
Gown, Astound®, X-Large	1
Gown, Astound®, X-Large with towel	1
Labels, sheet of 3, ½ x 2 in.	2
Marker, regular tip, violet	1
Mayo stand cover, 23 in.	1
Medicine cups, 2 oz.	2
Needle counter, 20-40, foam block, magnet	1
OB pad with wings, adhesive	1
Ruler, 6 in., flexible	1
Specimen container, 4½ in., with screw lid	1
Sponges, lap, 18 x 18 in.	5
Suction tubing, 6 mm x 12 ft.	1
Towels, cotton	6
Yankauer suction handle, bulbous tip, non-vented	1



General Gynecology

Case Quantity: 3







Cat. No.	Contents	Quantity
SPP99GY1AA	<i>core components</i> plus	
	Basin, emesis 700 cc	1
	Basin, ring, 7 qt.	1
	CSR wrap, 54 x 54 in.	1
	Sponge bowl, 32 oz.	1
	Sponge bowl, 48 oz.	1



General Gynecology

Case Quantity: 5

Cat. No.	Contents	Quantity
SPP99GY2AA	<i>core components</i> plus	
	One-compartment tray	1

 Basic drape fabric	 Reinforcements	 Side panel material
 Adhesive	 Incise	 Clear plastic panels and pouches

All products listed on this page are not made with natural rubber latex.

Standard Surgical Kits

Women's Health – Gynecology LAVH

Core components included in LAVH Pack and LAVH Plus kits

Contents	Quantity
Adhesive bandage, fabric, 2 x 3¾ in.	1
Adhesive bandages, plastic, 1 x 3 in.	3
Back table cover, 65 x 90 in.	1
Bedside bag	1
Blade, #11, rib back, carbon steel	1
Blade, #15, carbon steel	1
Drape, under buttocks with cuff, 36 x 49 in.	1
Fog inhibitor	1
Gauze, 4 x 4 in., 16-ply, x-ray	20
Gown, Astound®, fabric reinforced, X-Large	1
Gown, Astound®, X-Large with towel	1
Insufflation tubing, 12 ft.	1
Labels, sheet of 3, ½ x 2 in.	2
Marker, regular tip, violet	1
Mayo stand cover, 23 in.	1
Needle counter, 20-40, foam block, magnet	1
OB pad with wings, adhesive	1
Ruler, 6 in., flexible	1
Specimen container, 4½ in., with screw lid	1
Syringe, luer lock, 10 mL	1
Towels, cotton	10



LAVH Pack

Case Quantity: 4







Cat. No.	Contents	Quantity
SPP99LV2AA	<i>core components</i> plus	
	One-compartment tray	1



LAVH Plus

Case Quantity: 3

Cat. No.	Contents	Quantity
SPP99LV1AB	<i>core components</i> plus	
	Basin, emesis 700 cc	1
	Basins, ring, 7 qt.	2
	CSR wrap, 54 x 54 in.	1
	Sponge bowl, 32 oz.	1

	Basic drape fabric		Reinforcements		Side panel material
	Adhesive		Incise		Clear plastic panels and pouches

All products listed on this page are not made with natural rubber latex.

Standard Surgical Kits

Women's Health – Gynecology Pelvic Exams

Core components included in Pelvic Exam kits

Contents	Quantity
Instrument, sponge forceps, plastic, 9½ in.	1
Instrument, vaginal speculum, plastic, kleenspec, medium	1



Pelvic Exam







Case Quantity: 20

Cat. No.	Contents	Quantity
09-9000	<i>core components plus</i>	
	Basin, emesis 700 cc	1
	CSR, 24 x 24 in.	1
	Gauze, 4 x 4 in., 8-ply	4
	Mailer, slide	1
	Microscope slides, 3 x 1 in.	2
	Paper envelope, 3½ x 6½ in.	1
	Rubberband, #8	1
	Sponges, roundstick, x-ray, unstrung	4
	Towels, blue, scrim	2

Pelvic Exam

Case Quantity: 30

Cat. No.	Contents	Quantity
NI09-0027	<i>core components plus</i>	
	CSR, 24 x 24 in.	1
	Foam tray	1
	Gauze, 4 x 4 in., 12-ply	5
	Lubricating jelly, 3gm	3

 Basic drape fabric	 Reinforcements	 Side panel material
 Adhesive	 Incise	 Clear plastic panels and pouches

All products listed on this page are not made with natural rubber latex.

Standard Surgical Kits

Women's Health – Labor and Delivery-C-Section

Core components included in C-Section kits







Contents	Quantity
Bedside bag	1
Mayo stand cover, 23 in.	1
Medicine cup, 2 oz.	1
Suction tubing, 6 mm x 12 ft.	1
Umbilical cord clamp	1
Yankauer suction handle, bulbous tip, non-vented	1



C-Section

Case Quantity: 2

Cat. No.	Contents	Quantity
SPP99CS1AA	<i>core components plus</i>	
	Baby blanket	1
	Back table cover, 65 x 90 in.	1
	Basin, emesis 700 cc	1
	Basin, placenta, 3000 cc	1
	Basin, ring, 7 qt.	1
	Blades, #10, carbon steel	2
	Blade, #20, rib-back, carbon steel	1
	CSR wrap, 54 x 54 in.	1
	Drape, C-section, 106 x 122 x 77 in., with fluid pouch and fenestration	1
	Drape, half sheet, fan fold, 40 x 57 in.	1
	Dressing, non-adherent double sided, 3 x 8 in.	1
	Gown, Astound®, X-Large	1
	Gown, SmartSleeve™, X-Large with towel	1
	Labels, sheet of 3, ½ x 2 in.	3
	Lid	1
	Marker, regular tip, violet	1
	Needle counter, 20-40, foam block, magnet	1
	OB pad with wings, adhesive	1
	Ruler, 6 in., flexible	1
	Sponge bowls, 32 oz.	2
	Sponges, lap, 18 x 18 in.	10
	Syringe, bulb, 2 oz.	1
	Towels, cotton	8

 Basic drape fabric	 Reinforcements	 Side panel material
 Adhesive	 Incise	 Clear plastic panels and pouches

C-Section

Case Quantity: 2

Cat. No.	Contents	Quantity
SPP99CS6AA	<i>core components plus</i>	
	Baby blanket	1
	Back table cover, 65 x 90 in.	1
	Basin, emesis 700 cc	1
	Basin, placenta, 3000 cc	1
	Basins, ring, 7 qt.	2
	Blades, #10, carbon steel	2
	Blade, #20, rib-back, carbon steel	1
	Blood collection tube, 16 x 100 mm	1
	CSR wrap, 54 x 54 in.	1
	Culture tube, 16 x 100 mm	1
	Drape, C-section, 106 x 122 x 77 in., with fluid pouch and fenestration	1
	Dressing, non-adherent double sided, 3 x 8 in.	1
	Gauze, 4 x 4 in., 12-ply	5
	Gauze, 4 x 4 in., 16-ply, x-ray	10
	Gown, Astound®, X-Large with towel	1
	Gowns, SmartSleeve™, X-Large	2
	Infant cap	1
	Label, blank, 1 x 3 in.	1
	Labels, sheet of 3, ½ x 2 in.	3
	Light handle covers, flexible, green	2
	Marker, regular tip, violet	1
	Needle counter, 20-40, foam block, magnet	1
	Needle, hypodermic, 18G x 1½ in.	1
	OB pads with wings, adhesive	2
	Pitcher, specimen, 1,200 cc	1
	Ruler, 6 in., flexible	1
	Specimen container, 4½ in. with screw lid	1
	Sponge bowl, 32 oz.	1
	Sponges, lap, 18 x 18 in.	20
	Syringe, bulb, 2 oz.	1
	Syringe, luer lock, 10 mL	1
	Syringe, luer lock, 20 mL	1
	Towels, absorbent	2
	Towels, cotton	5
	Towels, non-absorbent with adhesive	4
	Zipper bag	1

All products listed on this page are not made with natural rubber latex.

Standard Surgical Kits

Women's Health – Labor and Delivery-C-Section

Core components included in C-Section Basic Set-up kits

Contents	Quantity
Baby blanket	1
Basin, placenta, 3000 cc	1
Bedside bag	1
Lid	1
Mayo stand cover, 23 in.	1
Syringe, bulb, 2 oz.	1



C-Section Basic Set-up







Case Quantity: 4

Cat. No.	Contents	Quantity
29800	<i>core components</i> plus	
	Back table cover, 50 x 90 in.	1
	Drape, C-section, 106 x 122 x 77 in., with fluid pouch and fenestration	1
	OB pad with wings, adhesive	1
	Umbilical cord clamp	1

C-Section Basic Set-up with Gowns

Case Quantity: 4

Cat. No.	Contents	Quantity
29781	<i>core components</i> plus	
	Back table cover, 44 x 90 in.	1
	Drape, C-section, 106 x 122 x 77 in., with fluid pouch	1
	Gowns, Astound®, large	3
	OB pad with wings, adhesive	1
	Towels, absorbent	2
	Transfer wrap, 23½ x 23½ in.	1

 Basic drape fabric	 Reinforcements	 Side panel material
 Adhesive	 Incise	 Clear plastic panels and pouches

All products listed on this page are not made with natural rubber latex.

Standard Surgical Kits

Women's Health – Labor and Delivery-C-Section



C-Section General

Case Quantity: 2

Cat. No.	Contents	Quantity
28000-200	Baby blanket	1
	Back table cover, 65 x 90 in.	1
	Basin, placenta, 3000 cc	1
	Basins, ring, 7 qt.	2
	Bedside bag	1
	Blades, #10, stainless steel	2
	Blade, #20, stainless steel	1
	Blood collection tube, 13 x 100 mm	1
	Blood collection tube, 16 x 100 mm	1
	CSR wraps, 54 x 54 in.	2
	Drape, C-section, 106 x 122 x 77 in., with fluid pouch	1
	Gowns, Astound®, large	3
	Lid	1
	Mayo stand cover, 23 in.	1
	Medicine cup, 2 oz.	1
	Needle counter, 15-30 count, foam strips, magnet	1
	OB pad with wings, adhesive	1
	Sponge bowl, 32 oz.	1
	Sponges, lap, 18 x 18 in.	20
	Suction tubing, 6 mm x 12 ft.	1
	Syringe, bulb, 2 oz.	1
	Towels, cotton	6
	Transfer wraps, 23½ x 23½ in.	2
	Umbilical cord clamp	1
	Yankauer suction handle, bulbous tip, non-vented	1

All products listed on this page are not made with natural rubber latex.

Standard Surgical Kits

Women's Health – Labor and Delivery-Vaginal Delivery



Birthing Room Delivery







Case Quantity: 6

Cat. No.	Contents	Quantity
9785	Baby blanket	1
	Back table cover, 44 x 75 in.	1
	Basin, placenta, 3000 cc	1
	Drape, abdominal with absorbent reinforcement, 57 x 39½ in.	1
	Drape, under buttocks with cuff, 36 x 49 in.	1
	Fluid control pad	1
	Gauze, 4 x 4 in., 16-ply, x-ray	20
	Gown, Astound®, large	1
	Lid	1
	Set-up cover, 40 x 71 in.	1
	Syringe, bulb, 2 oz.	1
	Towel, absorbent	1
	Towels, non-absorbent	2
	Umbilical cord clamp	1

General Delivery

Case Quantity: 3

Cat. No.	Contents	Quantity
SPP99DE3AA	<i>core components</i> plus	
	Baby blanket	1
	Back table cover, 50 x 90 in.	1
	Basins, ring, 7 qt.	2
	CSR wrap, 54 x 54 in.	1
	Culture tube, 17 x 100 mm	1
	Drape, abdominal with absorbent reinforcement, 57 x 39½ in.	1
	Drape, under buttocks with fluid control pouch, 38 x 48 in.	1
	Drapes, three-quarter, 52 x 76 in.	1
	Gauze, 4 x 4 in., 16-ply, x-ray	30
	Gauze, packing sponge, vaginal, 8-ply, x-xray, 4½ x 33 in.	1
	Gown, Astound®, fabric reinforced, X-Large	1
	Gown, SmartSleeve™, X-Large	1
	Infant cap	1
	Lithotomy leggings with cuff, 28 x 43 in.	2
	Needle, 22G x 1½ in.	1
	OB pads with wings, adhesive	2
	Sponge bowl, 16 oz., 500 cc	1
	Sponge bowl, 32 oz.	1
	Syringe, bulb, 2 oz.	1
	Syringe, luer lock, 10 mL	1
	Towels, absorbent	2
	Towels, cotton	4
	Umbilical cord clamp	1

	Basic drape fabric		Reinforcements		Side panel material
	Adhesive		Incise		Clear plastic panels and pouches

All products listed on this page are not made with natural rubber latex.

Standard Surgical Kits

Women's Health – Labor and Delivery-Vaginal Delivery

Core components included in Vaginal Delivery kits

Contents	Quantity
Basin, placenta, 3000 cc	1
Drape, half sheet, fan fold, 40 x 57 in.	1
Drape, under buttocks with fluid control pouch, 38 x 48 in.	1
Gown, Astound®, X-Large	1
Lid	1
OB pads with wings, adhesive	2
Set-up cover, 40 x 71 in.	1
Sponge bowl, 32 oz.	1
Syringe, bulb, 2 oz.	1
Towels, cotton	6
Umbilical cord clamp	1



Vaginal Delivery







Case Quantity: 3

Cat. No.	Contents	Quantity
SPP99DE2AA	<i>core components plus</i>	
	Baby blanket	1
	Back table cover, 50 x 90 in.	1
	Drape, abdominal with absorbent reinforcement, 57 x 39½ in.	1
	Gauze, 4 x 4 in., 16-ply, x-ray	20
	Gauze, packing sponge, vaginal, 8-ply, x-ray, 4½ x 33 in.	1
	Gown, SmartSleeve™, X-Large, reinforced	1
	Infant cap	1
	Lithotomy legging with cuff, 28 x 43 in.	2
	Needle, hypodermic, 22G x 1½ in.	1
	Sponge, bowl, 16 oz., 500 cc	1
	Sponges, lap, 18 x 18 in.	5
	Syringe, luer lock, 10 mL	1

Vaginal Delivery

Case Quantity: 6

Cat. No.	Contents	Quantity
SPP99DE1AA	<i>core components plus</i>	
	Back table cover, 44 x 75 in.	1
	Gauze, 4 x 4 in., 16-ply, x-ray	10
	Infant cap	1

	Basic drape fabric		Reinforcements		Side panel material
	Adhesive		Incise		Clear plastic panels and pouches

All products listed on this page are not made with natural rubber latex.

Standard Surgical Kits

Women's Health – Labor and Delivery-Vaginal Delivery

Core components included in General Obstetric kits

Contents	Quantity
Back table cover, 44 x 75 in.	1
Basin, placenta, 3000 cc	1
Drape, abdominal with absorbent reinforcement, 57 x 38½ in.	1
Lid	1
OB pad with wings, adhesive	1
Set-up cover, 40 x 71 in.	1
Surgical leggings with cuff, 31 x 48 in.	2
Towels, absorbent	3
Umbilical cord clamp	1



General Obstetrics







Case Quantity: 6

Cat. No.	Contents	Quantity
SPP99DE4AA	<i>core components plus</i>	
	Baby blanket	1
	Drape, under buttocks with fluid control pouch, 40 x 44½ in.	1
	Gauze, 4 x 4 in., 16-ply, x-ray	10
	Gauze, packing sponge, vaginal, 8-ply, x-ray, 4½ x 33 in.	1
	Gown, SmartGown™, X-Large, X-long, raglan sleeve	1
	Syringe, bulb, 2 oz.	1
	Syringe, bulb, 3 oz.	1

General Obstetrics

Case Quantity: 6

Cat. No.	Contents	Quantity
29850	<i>core components plus</i>	
	Baby blanket	1
	Drape, under buttocks with cuff, 36 x 49 in.	1
	Gauze, 4 x 4 in., 16-ply, x-ray	10
	Gauze, packing sponge, vaginal, 8-ply, x-ray, 4½ x 33 in.	1
	Gown, Astound®, large	1
	Syringe, bulb, 3 oz.	1

	Basic drape fabric		Reinforcements		Side panel material
	Adhesive		Incise		Clear plastic panels and pouches

All products listed on this page are not made with natural rubber latex.

Standard Surgical Kits

Women's Health – Labor and Delivery-Vaginal Delivery

Core components included in General Obstetric Protection kits

Contents	Quantity
Baby blanket	1
Back table cover, 44 x 75 in.	1
Basin, placenta, 3000 cc	1
Drape, abdominal with absorbent reinforcement, 57 x 38½ in.	1
Drape, under buttocks with fluid control pouch, 40 x 44½ in.	1
Gauze, packing sponge, vaginal, 8-ply, x-ray, 4½ x 33 in.	1
Gown, Astound®, large	1
Lid	1
OB pad with wings, adhesive	1
Set-up cover, 40 x 71 in.	1
Surgical leggings with cuff, 31 x 48 in.	2
Syringe, bulb, 2 oz.	1
Syringe, bulb, 3 oz.	1
Towels, absorbent	3
Umbilical cord clamp	1



General Obstetrics - Protection







Case Quantity: 6

Cat. No.	Contents	Quantity
SPP99LD4AA	<i>core components</i> plus	
	Sponges, lap, 4 x 8 in.	5

General Obstetrics - Ultra Protection

Case Quantity: 6

Cat. No.	Contents	Quantity
29900	<i>core components</i> plus	
	Gauze, 4 x 4 in., 16-ply, x-ray	10

 Basic drape fabric	 Reinforcements	 Side panel material
 Adhesive	 Incise	 Clear plastic panels and pouches

All products listed on this page are not made with natural rubber latex.

Standard Surgical Kits

Component Photo Index

Back table cover, 44 x 75 in.
SMS reinforcement, 23 x 75 in.



Back table cover, 50 x 90 in.
SMS reinforcement, 29 x 90 in.



Back table cover, 60 x 90 in.
SMS reinforcement, 29 x 90 in.



Bandage, esmark, 4 in. x 9 ft.



Bandage, self-adherent, 4 in. x 5 yd.



Basin, emesis, 700cc

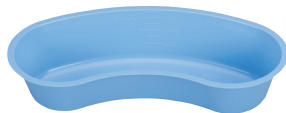

Basin, ring, 5,500cc



Bedside bag



Blade, #10, carbon steel



Blade, #11, carbon steel



Blade, #15, carbon steel



Bone wax



Cord, bipolar, 12 ft.



Cotton tip applicator, 3 in.



Cotton tip applicator, 6 in.



Dressing, non-adherent, 3 x 8 in.



Dressing, non-adherent,
oil emulsion, 3 x 3 in.



Eye pad, oval



Eye shield, clear plastic



Eye spears

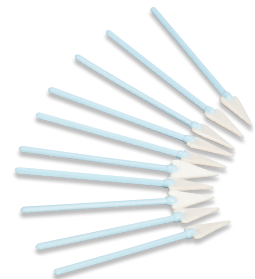

Standard Surgical Kits

Component Photo Index

Fog inhibitor



Gauze, 4 x 4 in., 12-ply, non x-ray



Gauze, 4 x 4 in., 16-ply, non x-ray



Gauze, 4 x 4 in., 16-ply, x-ray



Gown, Astound®, fabric reinforced, X-Large



Gown, Astound®, fabric reinforced, X-Large with towel



Gown, Astound®, X-Large



Gown, Astound®, X-Large with towel



Gown, SmartSleeve™, X-Large



Gown, SmartGown™, X-Large, X-long, raglan sleeve



Standard Surgical Kits

Component Photo Index

Instrument pouch



Labels, preprinted Ophthalmic, waterproof, 24/sheet



Instrument wipe

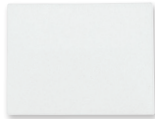

Labels, preprinted OR, waterproof, 30/sheet

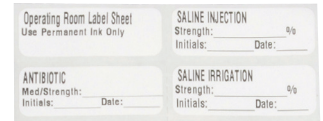

Insufflation tubing, 12 ft.



Labels, preprinted Plastic Surgery, waterproof, 32/sheet

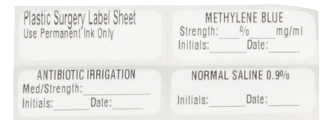

Irrigation set, bladder

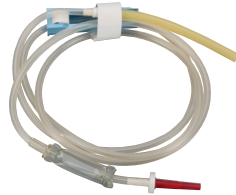

Leggings, 31 x 48 in., 6 in. cuff

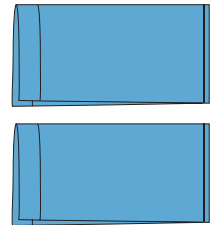

Irrigation set, TUR

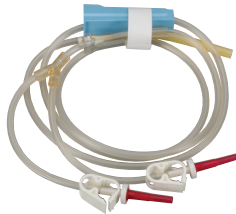

Lubricating jelly, 2 oz.



Labels, blank, 1/2 x 2 in., 3/strip



Marker, dual-tip



Labels, blank, standard



Marker, skin



Labels, preprinted ENT, waterproof, 22/sheet

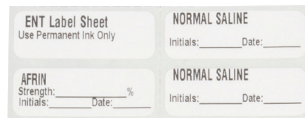

Marker, utility



Labels, preprinted Neurosurgery, waterproof, 30/sheet

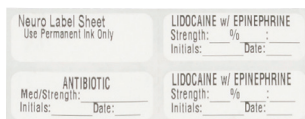

Mayo stand cover, 23 in.



Medicine cup, 2 oz.



Standard Surgical Kits

Component Photo Index

Needle counter, 10-20 count, foam block and adhesive



One-compartment tray, blue



Needle counter, 10-20 count, foam block, magnet



One-compartment tray, white



Needle counter, 20-40 count, foam block, magnet



Pitcher, specimen, 1,200cc



Needle counter, 40-70 count, foam block, magnet



Ruler, 6 in., flexible



Needle, 18G x 1½ in.



Specimen container, 4½ oz., with screw lid



Needle, 22G x 1½ in.



Sponge bowl, 16 oz.



Needle, 25G x 1½ in.



Sponge bowl, 32 oz.



Needle, 25G x 5⁄8 in.



Sponge bowl, 48 oz.



Needle, 30G x 1 in.



Needle, hypodermic, 22G x 1½ in.



Sponges, lap, 18 x 18 in.



Needle, precision glide, 27G x 1¼ in.



Needle, spinal, 18G x 3½ in.



Standard Surgical Kits

Component Photo Index

Sponges, neuro, 1/2 x 1/2 in., x-ray



Sponges, neuro, 1 x 1 in., x-ray



Sponge, super fluff, 6 x 6 3/4 in.



Sponges, tonsil, 3/8 in., x-ray



Stockinette, 12 x 48 in.



Suction tubing, 6mm x 12 ft.



Syringe, asepto, 50cc



Syringe, bulb, 2 oz.



Syringe, bulb, 3 oz.



Syringe, control, luer lock, 10mL



Syringe, luer lock, 3mL



Syringe, luer lock, 10mL



Syringe, luer lock, 20mL



Syringe, slip-tip, 1mL



Tongue depressor



Towel, absorbent



Towel, cotton



Towel, low lint



Towels, non-absorbent with adhesive



Yankauer suction handle, bulbous tip, non-vented



Vascular Access

Dressing Change Kits – Alcohol and PVP

Core Components in Dressing Change Kits including Alcohol and PVP

Contents	Quantity
Alcohol swabstick	1
Exam gloves, medium walled, pair	1
Face protection masks	1
Gauze, 4 x 4 in.	1
PVP swabstick	1
Tape, ¾ x 18 in.	1

Dressing Change Kits including Alcohol and PVP

Case Quantity: 30

Cat. No.	Contents	Quantity
NI03-4200A	<i>core components</i> plus	
	IV site adapter, male, luer lock	1
	Needle, 20G x 1 in.	2
	Skin protectant	1
	Sodium Chloride, 0.9%, glass ampule, 10 mL	2
	Syringe, luer lock, 10 mL	1
	Syringe, luer lock, 20 mL	1
	Tegaderm™ 1624W transparent dressing, 2¾ x 2¾ in.	

Dressing Change Kits – BIOPATCH® Protective Disk with CHG in Organizer

Core Components in Dressing Change Kits including BIOPATCH® Protective Disk with CHG in our Unique Organizer

Contents	Quantity
Alcohol single swabstick	1
BIOPATCH® protective disk with CHG	1
Cardinal Health™ unique dressing change organizer	1
Chloraprep®, 3 mL	1
Exam gloves, medium walled, pair	2
Face protection masks	2
Gauze, 4 x 4 in.	2
Hand sanitizer	2
Tape, ¾ x 18 in.	1

Dressing Change Kits including BIOPATCH® Protective Disk with CHG in our Unique Organizer

Case Quantity: 30

Cat. No.	Contents	Quantity
03-ORG43	<i>core components</i> plus	
	Change Date Label	1
	SorbaView SHIELD® 430A securement system with AFZ™, 3¾ x 4¾ in.	1

Dressing Change Kits including BIOPATCH® Protective Disk with CHG in our Unique Organizer

Case Quantity: 30

Cat. No.	Contents	Quantity
03-ORG26C	<i>core components</i> plus	
	Cardinal Health™ transparent dressing, TD-26 4 x 4¾ in.	1

Dressing Change Kits including BIOPATCH® Protective Disk with CHG in our Unique Organizer

Case Quantity: 30

Cat. No.	Contents	Quantity
03-ORG55A	<i>core components</i> plus	
	Tegaderm™ 1655 transparent dressing, 3½ x 4½ in.	1

Dressing Change Kits – Cardinal Health™ TD-26 Transparent Dressing

Core Components in Dressing Change Kits including Cardinal Health™ TD-26 Transparent Dressing

Contents	Quantity
Cardinal Health™ TD-26 transparent dressing, 4 x 4¾ in.	1
Change date label	1
ChloroPrep®, 3 mL	1
Exam gloves, medium walled, pair	1
Face protection mask	1
Gauze, 4 x 4 in.	2
Tape, ¾ x 18 in.	1
Towel	1

Dressing Change Kits including Cardinal Health™ TD-26 Transparent Dressing

Case Quantity: 30

Cat. No.	Contents	Quantity
03-0800	<i>core components plus</i>	
	Cotton tip applicator	1

Dressing Change Kits including Cardinal Health™ TD-26 Transparent Dressing

Case Quantity: 30

Cat. No.	Contents	Quantity
03-0500	<i>core components plus</i>	
	Alcohol single swabstick	1

Dressing Change Kits including Cardinal Health™ TD-26 Transparent Dressing

Case Quantity: 30

Cat. No.	Contents	Quantity
03-0400	<i>core components plus</i>	
	Alcohol single swabstick	1
	Cotton tip applicator	1
	IV sponge drain	1
	Skin protectant	1

Dressing Change Kits – Mastisol® Liquid Medical Adhesive

Core Components in Dressing Change Kits including Mastisol® Liquid Medical Adhesive

Contents	Quantity
Change date label	1
ChloroPrep®, 3 mL	1
Exam gloves, medium walled, pair	1
Face protection mask	1
Gauze, 4 x 4 in.	2
Mastisol® liquid medical adhesive	1
Towel	1

Dressing Change Kits including Mastisol® Liquid Medical Adhesive

Case Quantity: 30

Cat. No.	Contents	Quantity
03-2100CM	<i>core components plus</i>	
	BIOPATCH® protective disk with CHG	1
	Cardinal Health™ TD-55 transparent dressing, 3 x 4½ in.	1
	Tape, ¾ x 18 in.	1

Dressing Change Kits including Mastisol® Liquid Medical Adhesive

Case Quantity: 30

Cat. No.	Contents	Quantity
03-7700CM	<i>core components plus</i>	
	Alcohol single swabstick	1
	Cardinal Health™ transparent dressing, 3 x 4½ in.	1
	Tape, 1 x 18 in.	1

Dressing Change Kits including Mastisol® Liquid Medical Adhesive

Case Quantity: 50

Cat. No.	Contents	Quantity
03-2900M	<i>core components plus</i>	
	Alcohol single swabstick	1
	Tape, 1 x 18 in.	1
	Tegaderm™ CHG 1657 Transparent Dressing, 3½ x 4½ in.	1

Vascular Access

Dressing Change Kits – PICC and CVC including BIOPATCH® Protective Disk

Core Components in PICC and CVC Dressing Change Kits including BIOPATCH® Protective Disk with CHG

Contents	Quantity
BIOPATCH® protective disk with CHG	1
Change date label	1
Chloraprep®, 3 mL	1
Exam gloves, medium walled, pair	1
Face protection mask	1
Gauze, 4 x 4 in.	2
Tape, ¾ x 18 in.	1
Towel	1

PICC and CVC Dressing Change Kits including BIOPATCH® Protective Disk with CHG

Case Quantity: 30

Cat. No.	Contents	Quantity
03-2200	<i>core components</i> plus	
	Alcohol single swabstick	1
	Tegaderm™ 1616 transparent dressing with frame, 4 x 4¾ in.	1

PICC and CVC Dressing Change Kits including BIOPATCH® Protective Disk with CHG

Case Quantity: 30

Cat. No.	Contents	Quantity
03-2100C	<i>core components</i> plus	
	Cardinal Health™ transparent dressing, TD-55 3 x 4½ in.	1

PICC and CVC Dressing Change Kits including BIOPATCH® Protective Disk with CHG

Case Quantity: 30

Cat. No.	Contents	Quantity
03-2000	<i>core components</i> plus	
	Alcohol single swabstick	1
	Tegaderm™ 1626W Transparent Dressing, 4 x 4¾ in.	1

PICC and CVC Dressing Change Kits including BIOPATCH® Protective Disk with CHG

Case Quantity: 30

Cat. No.	Contents	Quantity
03-2000CVC	<i>core components</i> plus	
	Alcohol single swabstick	1
	SorbaView SHIELD® 430A securement system with AFZTM, 3¾ x 4¾ in.	1

PICC and CVC Dressing Change Kits including BIOPATCH® Protective Disk with CHG

Case Quantity: 30

Cat. No.	Contents	Quantity
03-2100	<i>core components</i> plus	
	Tegaderm™ 1655 Transparent Dressing, 3½ x 4½ in.	1

Dressing Change Kits – Tegaderm™ Transparent Dressing

Core Components in Dressing Change Kits including Tegaderm™ Transparent Dressing

Contents	Quantity
Change date label	1
ChloroPrep®, 3 mL	1
Exam gloves, medium walled, pair	1
Face protection mask	1
Gauze, 4 x 4 in.	2
Towel	1

Dressing Change Kits including Tegaderm™ Transparent Dressing

Case Quantity: 20		
Cat. No.	Contents	Quantity
NI03-0544A	<i>core components plus</i>	
	Tape, 1 x 18 in.	1
	Tape measure	1
	Tegaderm™ 1626W transparent dressing, 4 x 4¾ in.	1

Dressing Change Kits including Tegaderm™ Transparent Dressing

Case Quantity: 50		
Cat. No.	Contents	Quantity
03-9600	<i>core components plus</i>	
	Skin protectant single swabstick	1
	Tape, ¾ x 18 in.	1
	Tegaderm™ 1616 transparent dressing with frame, 4 in. x 4¾ in.	1

Dressing Change Kits including Tegaderm™ Transparent Dressing

Case Quantity: 50		
Cat. No.	Contents	Quantity
NI03-0130B	<i>core components plus</i>	
	Alcohol single swabstick	1
	Tape, ¾ x 18 in.	1
	Tegaderm™ 1655 transparent dressing, 3½ x 4½ in.	1

Dressing Change Kits – Tegaderm™ CHG Transparent Dressing

Core Components in Dressing Change Kits including Tegaderm™ CHG Transparent Dressing

Contents	Quantity
Alcohol single swabstick	1
Change date label	1
ChloroPrep®, 3 mL	1
Exam gloves, medium walled, pair	1
Face protection mask	1
Gauze, 4 x 4 in.	2
Tape, ¾ x 18 in.	1
Towel	1

Dressing Change Kits including Tegaderm™ CHG Transparent Dressing

Case Quantity: 50		
Cat. No.	Contents	Quantity
03-2800	<i>core components plus</i>	
	Tegaderm™ CHG 1658 transparent dressing, 4 x 4¾ in.	1

Dressing Change Kits including Tegaderm™ CHG Transparent Dressing

Case Quantity: 50		
Cat. No.	Contents	Quantity
03-2901	<i>core components plus</i>	
	Skin Protectant.	1
	Tegaderm™ 1877-2100 CHG IV securement dressing 4½ x 3½ in.	1

Vascular Access

IV Start Kits – Alcohol and PVP

Core Components in Dressing Change Kits including Tegaderm™ and Cardinal Health™ Transparent Dressing

Contents	Quantity
Change date label	1
Gauze, 2 x 2 in.	2
Tape, ¾ x 18 in.	1
Tourniquet, blue textured, ¾ in.	1

IV Start Kits including Alcohol and PVP

Case Quantity: 20

Cat. No.	Contents	Quantity
01-1900C	<i>core components</i> plus	
	Alcohol pads	2
	Cardinal Health™ TD-24 transparent dressing, 2¾ x 2¾ in.	1
	PVP pad	1
	Towel	1

IV Start Kits including Alcohol and PVP

Case Quantity: 20

Cat. No.	Contents	Quantity
01-09001C	<i>core components</i> plus	
	Alcohol pads	2
	Cardinal Health™ TD-24 transparent dressing, 2¾ x 2¾ in.	1
	PVP pad	1

IV Start Kits including Alcohol and PVP

Case Quantity: 20

Cat. No.	Contents	Quantity
01-0901C	<i>core components</i> plus	
	Alcohol pads	2
	Cardinal Health™ TD-24 transparent dressing, 2¾ x 2¾ in.	1

IV Start Kits including Alcohol and PVP

Case Quantity: 20

Cat. No.	Contents	Quantity
01-1900A	<i>core components</i> plus	
	Alcohol pad	1
	PVP pad	1
	Tegaderm™ 1624W transparent dressing, 2¾ x 2¾ in.	1
	Towel	1

IV Start Kits including Alcohol and PVP

Case Quantity: 20

Cat. No.	Contents	Quantity
01-09001A	<i>core components</i> plus	
	Alcohol pad	1
	PVP pad	1
	Tegaderm™ 1624W transparent dressing, 2¾ x 2¾ in.	1

IV Start Kits – ChloroPrep® CHG 1 mL

Core Components in IV Start Kits including ChloroPrep® CHG 1 mL

Contents	Quantity
Change date label	1
ChloroPrep®, 1 mL	1
Gauze, 2 x 2 in.	2
Tape, ¾ x 18 in.	1

IV Start Kits including ChloroPrep® CHG 1 mL

Case Quantity: 100

Cat. No.	Contents	Quantity
01-9001CS	<i>core components</i> plus	
	Cardinal Health™ TD-24 transparent dressing, 2¾ x 2¾ in.	1
	Tourniquet, orange textured, 1 in.	1

IV Start Kits including ChloroPrep® CHG 1 mL

Case Quantity: 100

Cat. No.	Contents	Quantity
01-98001C	<i>core components</i> plus	
	Cardinal Health™ TD-14 transparent dressing with frame, 2¾ x 2¾ in.	1
	Tourniquet, blue textured, ¾ in.	1

IV Start Kits including ChloroPrep® CHG 1 mL

Case Quantity: 100

Cat. No.	Contents	Quantity
01-9101CSP	<i>core components</i> plus	
	Cardinal Health™ TD-24 transparent dressing, 2¾ x 2¾ in.	1
	StatLock® pediatric	1
	Tourniquet, blue textured, ¾ in.	1

IV Start Kits including ChloroPrep® CHG 1 mL

Case Quantity: 100

Cat. No.	Contents	Quantity
01-9001C	<i>core components</i> plus	
	Cardinal Health™ TD-24 transparent dressing, 2¾ x 2¾ in.	1
	Tourniquet, blue textured, ¾ in.	1

IV Start Kits including ChloroPrep® CHG 1 mL

Case Quantity: 100

Cat. No.	Contents	Quantity
01-9101SLC	<i>core components</i> plus	
	Cardinal Health™ TD-24 transparent dressing, 2¾ x 2¾ in.	1
	StatLock® IV select stabilization device	1
	Tourniquet, blue textured, ¾ in.	1

Vascular Access

IV Start Kits – Chloraprep® CHG 1 mL

Core Components in IV Start Kits including Chloraprep® CHG 1 mL

Contents	Quantity
Change date label	1
Chloraprep®, 1 mL	1
Gauze, 2 x 2 in.	2
Tape, ¾ x 18 in.	1

IV Start Kits including Chloraprep® CHG 1 mL

Case Quantity: 100

Cat. No.	Contents	Quantity
01-93001A	<i>core components</i> plus	
	Tegaderm™ 1624W transparent dressing, 2¾ x 2¾ in.	1
	Tourniquet, blue textured, ¾ in.	1
	Towel	1

IV Start Kits including Chloraprep® CHG 1 mL

Case Quantity: 100

Cat. No.	Contents	Quantity
01-98001A	<i>core components</i> plus	
	Tegaderm™ 1614 transparent dressing with frame, 3¾ x 2¾ in.	1
	Tourniquet, blue textured, ¾ in.	1

IV Start Kits including Chloraprep® CHG 1 mL

Case Quantity: 100

Cat. No.	Contents	Quantity
01-92001A	<i>core components</i> plus	
	Exam gloves, medium pair	1
	Tegaderm™ 1624W transparent dressing, 2¾ x 2¾ in.	1
	Tourniquet, blue textured, ¾ in.	1
	Towel	1

IV Start Kits including Chloraprep® CHG 1 mL

Case Quantity: 100

Cat. No.	Contents	Quantity
01-9101SLP	<i>core components</i> plus	
	StatLock® pediatric	1
	Tegaderm™ 1624W transparent dressing, 2¾ x 2¾ in.	1
	Tourniquet, blue textured, ¾ in.	1

IV Start Kits including Chloraprep® CHG 1 mL

Case Quantity: 100

Cat. No.	Contents	Quantity
01-91001S	<i>core components</i> plus	
	Tegaderm™ 1624W transparent dressing, 2¾ x 2¾ in.	1
	Tourniquet, orange textured, 1 in.	1

IV Start Kits including Chloraprep® CHG 1 mL

Case Quantity: 100

Cat. No.	Contents	Quantity
01-9001A	<i>core components</i> plus	
	Tegaderm™ 1624W transparent dressing, 2¾ x 2¾ in.	1
	Tourniquet, blue textured, ¾ in.	1

IV Start Kits including Chloraprep® CHG 1 mL

Case Quantity: 50

Cat. No.	Contents	Quantity
01-96001A	<i>core components</i> plus	
	Tegaderm™ 1683 IV securement dressing, 2¾ x 2¾ in.	1
	Tourniquet, blue textured, ¾ in.	1

IV Start Kits – ChloroPrep® CHG FREPP®

Core Components in IV Start Kits including ChloroPrep® CHG FREPP®

Contents	Quantity
Change date label	1
ChloroPrep® FREPP®, 1.5 mL	1
Gauze, 2 x 2 in.	2
Tape, ¾ x 18 in.	1

IV Start Kits including ChloroPrep® CHG FREPP®

Case Quantity: 100		
Cat. No.	Contents	Quantity
01-9000SLC	<i>core components</i> plus	
	StatLock® IV select stabilization device	1
	Tegaderm™ 1624W transparent dressing, 2¾ x 2¾ in.	1
	Tourniquet, blue textured, ¾ in.	1

IV Start Kits including ChloroPrep® CHG FREPP®

Case Quantity: 100		
Cat. No.	Contents	Quantity
01-9000C	<i>core components</i> plus	
	Cardinal Health™ TD-24 transparent dressing, 2¾ x 2¾ in.	1
	Tourniquet, blue textured, ¾ in.	1

IV Start Kits including ChloroPrep® CHG FREPP®

Case Quantity: 100		
Cat. No.	Contents	Quantity
01-9000A	<i>core components</i> plus	
	Tegaderm™ 1624W transparent dressing, 2¾ x 2¾ in.	1
	Tourniquet, blue textured, ¾ in.	1

IV Start Kits including ChloroPrep® CHG FREPP®

Case Quantity: 100		
Cat. No.	Contents	Quantity
01-9801A	<i>core components</i> plus	
	Tegaderm™ 1614 transparent dressing with frame, 3¾ x 2¾ in.	1
	Tourniquet, blue textured, ¾ in.	1

IV Start Kits including ChloroPrep® CHG FREPP®

Case Quantity: 100		
Cat. No.	Contents	Quantity
01-9301A	<i>core components</i> plus	
	Tegaderm™ 1624W transparent dressing, 2¾ x 2¾ in.	1
	Tourniquet, blue textured, ¾ in.	1
	Towel	1

IV Start Kits including ChloroPrep® CHG FREPP®

Case Quantity: 100		
Cat. No.	Contents	Quantity
01-9000S	<i>core components</i> plus	
	Tegaderm™ 1624W transparent dressing, 2¾ x 2¾ in.	1
	Tourniquet, orange textured, 1 in.	1

Vascular Access

IV Start Kits – Chloraprep® CHG FREPP®

Core Components in IV Start Kits including Chloraprep® CHG FREPP®

Contents	Quantity
Change date label	1
Chloraprep® FREPP®, 1.5 mL	1
Gauze, 2 x 2 in.	2
Tape, ¾ x 18 in.	1

IV Start Kits including Chloraprep® CHG FREPP®

Case Quantity: 50

Cat. No.	Contents	Quantity
01-9701A	<i>core components</i> plus	
	Tegaderm™ 1683 IV Securement Dressing, 2½ x 2¾ in.	1
	Tourniquet, blue textured, ¾ in.	1
	Towel	1

IV Start Kits including Chloraprep® CHG FREPP®

Case Quantity: 50

Cat. No.	Contents	Quantity
01-9601A	<i>core components</i> plus	
	Tegaderm™ 1683 IV Securement Dressing, 2½ x 2¾ in.	1
	Tourniquet, blue textured, ¾ in.	1

IV Start Kits including Chloraprep® CHG FREPP®

Case Quantity: 50

Cat. No.	Contents	Quantity
01-9083SFT	<i>core components</i> plus	
	Tegaderm™ 1683 IV Securement Dressing, 2½ x 2¾ in	1
	Tourniquet, orange textured, 1 in.	1

IV Start Kits – Chloraprep® CHG Swab

IV Start Kits including Chloraprep® CHG Swab

Case Quantity: 50

Cat. No.	Contents	Quantity
01-0200	Change date label	1
	Chloraprep® single swabstick	1
	Gauze, 2 x 2 in.	2
	Tape, ¾ x 18 in.	1
	Tegaderm™ 1624W transparent dressing, 2¾ x 2¾ in.	1
	Tourniquet, blue textured, ¾ in.	1

IV Start Kits – PDI Prevantics™ CHG Skin Antiseptic

Core Components in IV Start Kits including PDI Prevantics™ CHG Skin Antiseptic (3.15% CHG, 70% IPA)

Contents	Quantity
Change date label	1
Gauze, 2 x 2 in.	2
PDI Prevantics™ CHG Skin Antiseptic Swab, 1 mL	1
Tape, ¾ x 18 in.	1

IV Start Kits including PDI Prevantics™ CHG Skin Antiseptic (3.15% CHG, 70% IPA)

Case Quantity: 100

Cat. No.	Contents	Quantity
01-8700A	<i>core components</i> plus	
	Tegaderm™ 1614 transparent dressing with frame, 3¾ x 2¾ in.	1
	Tourniquet, blue textured, ¾ in.	1

IV Start Kits including PDI Prevantics™ CHG Skin Antiseptic (3.15% CHG, 70% IPA)

Case Quantity: 100

Cat. No.	Contents	Quantity
01-8700C	<i>core components</i> plus	
	Cardinal Health™ TD-14 transparent dressing with frame, 2¾ x 2¾ in.	1
	Tourniquet, blue textured, ¾ in.	1

IV Start Kits including PDI Prevantics™ CHG Skin Antiseptic (3.15% CHG, 70% IPA)

Case Quantity: 100

Cat. No.	Contents	Quantity
01-8000A	<i>core components</i> plus	
	Tegaderm™ 1624W transparent dressing, 2¾ x 2¾ in.	1
	Tourniquet, blue textured, ¾ in.	1

IV Start Kits including PDI Prevantics™ CHG Skin Antiseptic (3.15% CHG, 70% IPA)

Case Quantity: 100

Cat. No.	Contents	Quantity
01-8000C	<i>core components</i> plus	
	Cardinal Health™ TD-24 transparent dressing, 2¾ x 2¾ in.	1
	Tourniquet, blue textured, ¾ in.	1

IV Start Kits including PDI Prevantics™ CHG Skin Antiseptic (3.15% CHG, 70% IPA)

Case Quantity: 100

Cat. No.	Contents	Quantity
01-8000S	<i>core components</i> plus	
	Tegaderm™ 1624W Transparent Dressing, 2¾ x 2¾ in.	1
	Tourniquet, orange textured, 1 in.	1

IV Start Kits including PDI Prevantics™ CHG Skin Antiseptic (3.15% CHG, 70% IPA)

Case Quantity: 100

Cat. No.	Contents	Quantity
01-8000CS	<i>core components</i> plus	
	Cardinal Health™ TD-24 transparent dressing, 2¾ x 2¾ in.	1
	Tourniquet, orange textured, 1 in.	1

Vein Ablation

Vein Ablation Kits

Kit Number	VEINBABETA	VEINBACHLO	VEINPLBETA	VEINPLCHLO
Case Quantity	5	5	5	5
BOWLS and TRAYS				
Bowl, sponge, 16 oz.	1	1	1	1
Transfer tray, two-compartment, 9 x 4 in.	1		1	
DRAPES and GOWNS				
Drape, half sheet, fan fold, 40 x 57 in.			1	1
Drape, split, 77 x 101 in.	1	1	1	1
Gowns, Astound®, X-Large	2	2	2	2
DRESSINGS				
Bandages, elastic, 6 in. x 5.8 yds.			2	2
Gauze, 4 x 4 in., 12-ply	10	10	20	20
Gauze, 4½ in. x 4.1 yds., 6-ply, roll			2	2
Strip, tape, ½ x 4 in., 3 per card	2	2	2	2
DRUGS				
Lidocaine, 2%, glass ampule, 10 mL	1	1	1	1
LABELS				
Blank labels	3	3	3	3
Lidocaine labels	2	2	2	2
PVP scrub label	1		1	
Saline labels	2	2	2	2
Tumescent solution labels	2	2	2	2
MISCELLANEOUS				
Clamps, towel, 4½ in. plastic, blue, curved			2	2
Light handle cover, flexible			1	1
Probe cover with rubber bands, 5 x 96 in.	1	1	1	1
Table cover, 44 x 90 in.	1	1	1	1
Tubing, infiltration, 200 in., single spike with 2 clamps			1	1
Ultrasound gel, 20 gm, foil	2	2	3	3
NEEDLES, NEEDLE SAFETY COUNTER and SYRINGES				
Needle, 25G x ½ in.	1	1	1	1
Needle, 25G x ⅝ in.			1	1
Needle, filter, 18G x 1½ in.	1	1	1	1
Needle holder, foam block	1	1	1	1
Needle, spinal, 20G x 3½ in.			1	1
Syringe, luer lock, 5 mL			1	1
Syringe, luer lock, 10 mL	1	1	1	1
Syringe, luer lock, 20 mL	1	1	1	1
SCALPELS				
Scalpel, #11, stainless steel	1	1	1	1
SKIN PREP				
ChloroPrep® applicator, 2%, orange tint, 26 mL		1		1
PVP scrub, 7.5%, 2 oz.	1		1	
SPONGE STICKS and SKIN MARKER				
Prep resistant skin marker with ruler	1	1	1	1
Sponges, stick, 2 x 2 in., square foam head	2		2	
TOWELS				
Towels, absorbent, white	2	2	2	2
Towels, OR, blue	4	4	6	6

Vein Ablation Kits – Basic Kit with PVP Scrub or ChloroPrep®



Basic Vein Ablation Kit with PVP Scrub

Case Quantity: 5

Cat. No.	Contents	Quantity
VEINBABETA	Back table cover, 44 x 90 in.	1
	Blank labels	3
	Bowl, sponge, 16 oz.	1
	Drape, split, 77 x 101 in.	1
	Gauze, 4 x 4 in., 12-ply	10
	Gowns, Astound®, X-Large	2
	Lidocaine, 2%, glass ampule, 10 mL	1
	Lidocaine labels	2
	Needle, 25G x 1½ in.	1
	Needle, filter, 18G x 1½ in.	1
	Needle holder, foam block	1
	Prep resistant skin marker with ruler	1
	Probe cover with rubber bands, 5 x 96 in.	1
	PVP scrub, 7.5%, 2 oz.	1
	PVP scrub label	1
	Saline labels	2
	Scalpel, #11, stainless steel	1
	Sponges, stick, 2 x 2 in., square foam head	2
	Strip, tape, ½ x 4 in., 3 per card	2
	Syringe, luer lock, 10 mL	1
	Syringe, luer lock, 20 mL	1
	Towels, OR, blue	4
	Towels, absorbent, white	2
	Transfer tray, two-compartment, 9 x 4 in.	1
	Tumescent solution labels	2
	Ultrasound gel, 20 gm, foil	2

Basic Vein Ablation Kit with ChloroPrep®

Case Quantity: 5

Cat. No.	Contents	Quantity
VEINBACHLO	Back table cover, 44 x 90 in.	1
	Blank labels	3
	Bowl, sponge, 16 oz.	1
	ChloroPrep® applicator, 2%, orange tint, 26 mL	1
	Drape, split, 77 x 101 in.	1
	Gauze, 4 x 4 in., 12-ply	10
	Gowns, Astound®, X-Large	2
	Lidocaine, 2%, glass ampule, 10 mL	1
	Lidocaine labels	2
	Needle, 25G x 1½ in.	1
	Needle, filter, 18G x 1½ in.	1
	Needle holder, foam block	1
	Prep resistant skin marker with ruler	1
	Probe cover with rubber bands, 5 x 96 in.	1
	Saline labels	2
	Scalpel, #11, stainless steel	1
	Strips, tape, ½ x 4 in., 3 per card	2
	Syringe, luer lock, 10 mL	1
	Syringe, luer lock, 20 mL	1
	Towels, absorbent, white	2
	Towels, OR, blue	4
	Tumescent solution labels	2
	Ultrasound gel, 20 gm, foil	2

Vein Ablation

Vein Ablation Kits – Premium Kit with PVP Scrub or ChloraPrep®



Premium Vein Ablation Kit with PVP Scrub

Case Quantity: 5

Cat. No.	Contents	Quantity
VEINPLBETA	Back table cover, 44 x 90 in.	1
	Bandages, elastic, 6 in. x 5.8 yds.	2
	Blank labels	3
	Bowl, sponge, 16 oz.	1
	Clamps, towel, 4½ in., plastic, blue, curved	2
	Drape, half sheet, fan fold, 40 x 57 in.	1
	Drape, split, 77 x 101 in.	1
	Gauze, 4 x 4 in., 12-ply	20
	Gauze, 4½ in. x 4.1 yds., 6-ply, roll	2
	Gowns, Astound®, X-Large	2
	Lidocaine, 2%, glass ampule, 10 mL	1
	Lidocaine labels	2
	Light handle cover, flexible	1
	Needle, 25G x ⅝ in.	1
	Needle, 25G x 1½ in.	1
	Needle, filter, 18G x 1½ in.	1
	Needle holder, foam block	1
	Needle, spinal, 20G x 3½ in.	1
	Prep resistant skin marker with ruler	1
	Probe cover with rubber bands, 5 x 96 in.	1
	PVP scrub, 7.5%, 2 oz.	1
	PVP scrub label	1
	Saline labels	2
	Scalpel, #11, stainless steel	1
	Sponge, stick, 2 x 2 in., square foam head	2
	Strips, tape, ½ x 4 in., 3 per card	2
	Syringe, luer lock, 5 mL	1
	Syringe, luer lock, 10 mL	1
	Syringe, luer lock, 20 mL	1
	Towels, absorbent, white	2
	Towels, OR, blue	6
	Transfer tray, two-compartment, 9 x 4 in.	1
	Tubing, infiltration, 200 in., single spike with 2 clamps	1
	Tumescent solution labels	2
	Ultrasound gel, 20 gm, foil	3

Premium Vein Ablation Kit with ChloraPrep®

Case Quantity: 5

Cat. No.	Contents	Quantity
VEINPLCHLO	Back table cover, 44 x 90 in.	1
	Bandages, elastic, 6 in. x 5.8 yds.	2
	Blank labels	3
	Bowl, sponge, 16 oz.	1
	ChloraPrep® applicator, 2%, orange tint, 26 mL	1
	Clamps, towel, 4½ in. plastic, blue, curved	2
	Drape, half sheet, fan fold, 40 x 57 in.	1
	Drape, split, 77 x 101 in.	1
	Gauze, 4 x 4 in., 12-ply	20
	Gauze, 4½ in. x 4.1 yds., 6-ply, roll	2
	Gowns, Astound®, X-Large	2
	Lidocaine, 2%, glass ampule, 10 mL	1
	Lidocaine labels	2
	Light handle cover, flexible	1
	Needle, 25G x ⅝ in.	1
	Needle, 25G x 1½ in.	1
	Needle, filter, 18G x 1½ in.	1
	Needle holder, foam block	1
	Needle, spinal, 20G x 3½ in.	1
	Prep resistant skin marker with ruler	1
	Probe cover with rubber bands, 5 x 96 in.	1
	Saline labels	2
	Scalpel, #11, stainless steel	1
	Strips, tape, ½ x 4 in., 3 per card	2
	Syringe, luer lock, 5 mL	1
	Syringe, luer lock, 10 mL	1
	Syringe, luer lock, 20 mL	1
	Towels, absorbent, white	2
	Towels, OR, blue	6
	Tubing, infiltration, 200 in., single spike with 2 clamps	1
	Tumescent solution labels	2
	Ultrasound gel, 20 gm, foil	3



**For more information, please contact
your Cardinal Health Sales Representative.**

cardinalhealth.com/presource